



BA42



BA42 REEL

Features

BA42 series is a Contractor Grade, efficient, field configurable and durable LED strip light. It is suitable for use in coves, under cabinets, in shelves, millwork, and virtually anywhere a linear light is required.

Mounting

BA strip is equipped with 3M™ adhesive transfer tape.

Applications

Indoor only - millwork, cove, architectural reveals, undercabinet, display case, handrail, accent lighting.

Approvals

Class 2 damp listed

Operating voltage
24 VDC

Average Life (L70)
50,000 hours

Warranty
5 years



Technical information

TYPE	BA42		
	SO	HO	VHO
OUTPUT OPTIONS			
Lumens Output (3000K)	196 lm/ft	373 lm/ft	539 lm/ft
Average Power Consumption (for a 4' section)	2.0 W/ft	4.0 W/ft	6.0 W/ft
Efficacy	98 lm/W	93 lm/W	90 lm/W
Cutting Increment (in)	1.97"		
Pitch Length	0.28"		
Max Run Length (in series to 30W)	14 ft	7 ft	4 ft
Max Run Length (in series to 60W)	40 ft	16 ft	10 ft
Max Run Length (in series to 96W)	50 ft	30 ft	24 ft
Dimensions	0.39"W x 0.06" H		
Operating Temperature	-40°F -104°F (-40° C - 40° C)		

CCT	Multiplier (reference - 3000K)	CRI
2100K	0.86	90
2400K	0.90	90
2700K	0.90	90
3000K	1.00	90
3500K	1.03	90

Section Start/End Options

SL

Soldered lead wires (72")

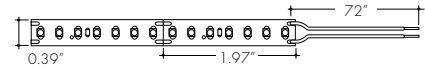

NC

No connector

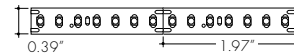

Ordering code

MODEL	OUTPUT	CCT	SECTION START	SECTION END	LENGTH
BA42 - Basics Strip	SO - Standard HO - High VHO - Very High	21K - 2100K 24K - 2400K 27K - 2700K 30K - 3000K 35K - 3500K	(Leave blank for Reels)	(Leave blank for Reels)	R16 - Reel, 16ft ¹ R50 - Reel, 50ft ²
			SL - Soldered lead wires (72") NC - No connector	SL - Soldered lead wires (72") NC - No connector	— - Nominal Length, 1 ft increments ³

1 - R16, 16 ft reels include 3 each of LL-PFC-10-72 and LL-PJC-10-03
2 - R50, 50 ft reels include 6 each of LL-PFC-10-72 and LL-PJC-10-03
3 - Ordered in one foot increments. See chart above for max run length.

Minii Connectors

Minii connectors are easy, field-installable accessories that make joining LL strip simple! Their minimal width allows them to fit into extrusions, while their transparent frame eliminates dark spots.
Note: verify internal extrusion dimensions to confirm compatibility

LL-PJC-10-03

Jumper minii connector with 3" wire for BA42 LED strip

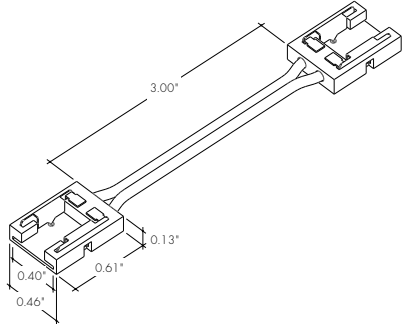

LL-PFC-10-72

Power feed minii connector with 72" wire for BA42 LED strip

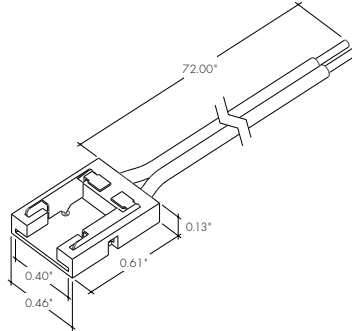

LL-BSC-10

Butt splice minii connector for BA42 LED strip

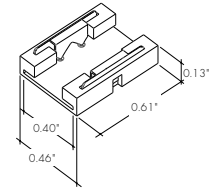

Sample Layout

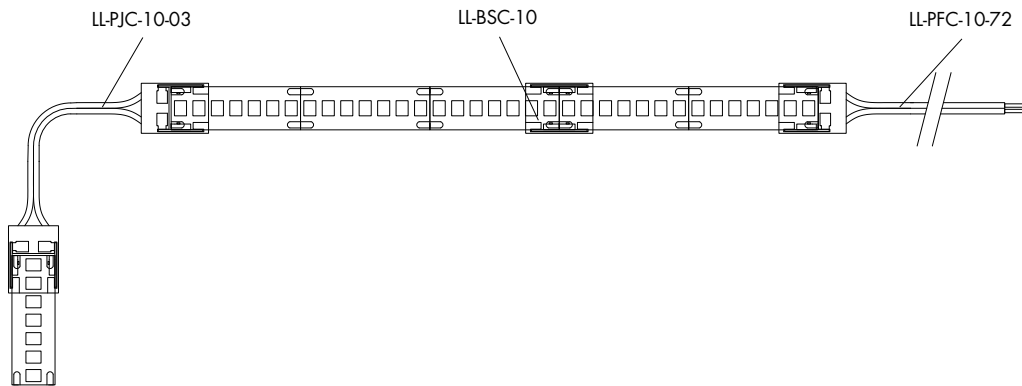

Accessories

CL1

Mounting clip

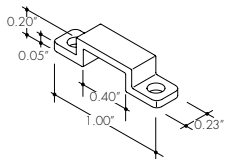

LVSP-4T-BK

Low Voltage, 4 Terminal Splice Box, Black

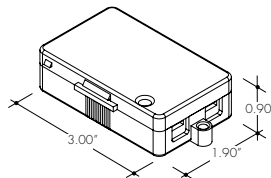

LL-ZIP

Cable/Wire Strain Relief Clip

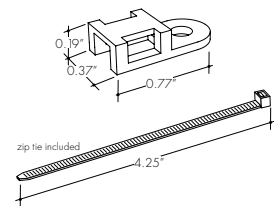

Recommended every 12" when LineLED strip is facing down

Lens Options / Light Transmission



Clear



Half Frosted



Frosted

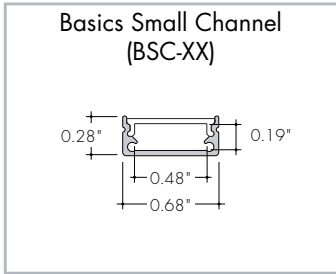

C	HF	F
82%	71%	54%

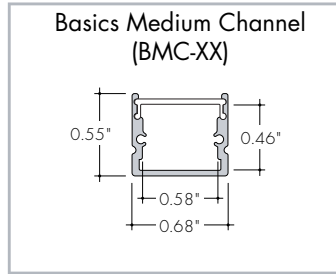

C	HF	F
75%	69%	53%

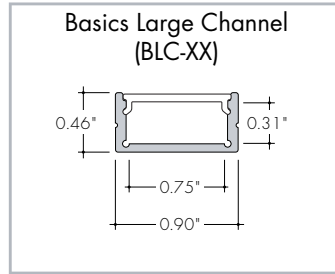

C	HF	F
83%	74%	58%

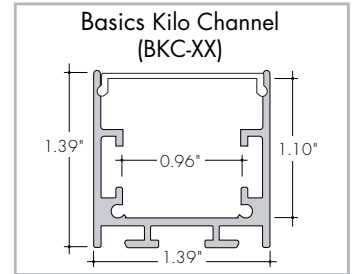

HF
59%

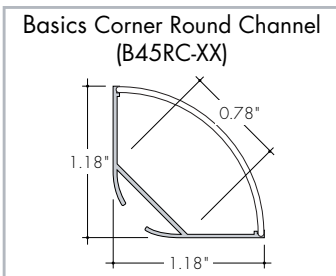

C	HF	F
93%	85%	73%

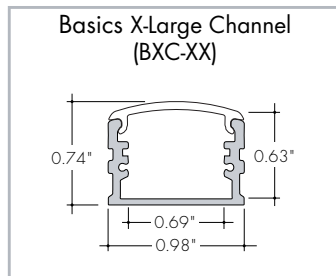

F
53%

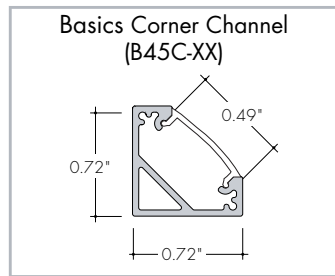

C	HF	F
76%	68%	50%

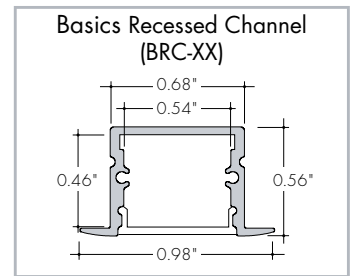

C	HF	F
75%	69%	53%

Installation

All mounting channels are field cuttable using miter saw with circular blade suitable for cutting aluminum.

Ordering

Extrusions are sold separately. View respective specsheets for details on ordering extrusions and their accessories (endcaps, mounting brackets, etc).

Led Dotting per Extrusion with BA42

different output options may slightly vary

Extrusion	Clear Lens	Half-Frosted Lens	Frosted Lens
BSC	CD	CD	CD
BMC	CD	SD	ND
BLC	CD	CD	SD
BXC	-	-	ND
B45RC	CD	CD	ND
BKC	-	ND	-
B45C	CD	CD	SD
BRC	CD	SD	ND

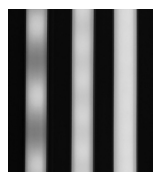

CD SD ND
CD - Clear Dotting
SD - Slight Dotting
ND - No Dotting

Voltage Drop Calculator

The below chart assumes nominal voltage of 24 Volts and a Voltage Drop Allowance of 3% through the wire

Wattage [W]	Maximum Wire Length From Power Supply to Start of Run [ft]						
	12 AWG	14 AWG	16 AWG	18 AWG	20 AWG	22 AWG	24 AWG
5	1088.2	684.4	430.3	270.6	170.2	107.1	67.3
10	544.1	342.2	215.1	135.3	85.1	53.5	33.7
15	362.7	228.1	143.4	90.2	56.7	35.7	22.4
20	272.0	171.1	107.6	67.7	42.6	26.8	16.8
25	217.6	136.9	86.1	54.1	34.0	21.4	13.5
30	181.4	114.1	71.7	45.1	28.4	17.8	11.2
35	155.5	97.8	61.5	38.7	24.3	15.3	9.6
40	136.0	85.5	53.8	33.8	21.3	13.4	8.4
45	120.9	76.0	47.8	30.1	18.9	11.9	7.5
50	108.8	68.4	43.0	27.1	17.0	10.7	6.7
55	98.9	62.2	39.1	24.6	15.5	9.7	6.1
60	90.7	57.0	35.9	22.6	14.2	8.9	5.6
65	83.7	52.6	33.1	20.8	13.1	8.2	5.2
70	77.7	48.9	30.7	19.3	12.2	7.6	4.8
75	72.5	45.6	28.7	18.0	11.3	7.1	4.5
80	68.0	42.8	26.9	16.9	10.6	6.7	4.2
85	64.0	40.3	25.3	15.9	10.0	6.3	4.0
90	60.5	38.0	23.9	15.0	9.5	5.9	3.7
96	56.7	35.6	22.4	14.1	8.9	5.6	3.5

Power Supplies

See Power Supply instructions and spec sheet for wiring information. For a complete list of compatible dimmers, see Compatible Dimming Chart on the Resources page.

0-10V - 5% Dimming

MODEL	INPUT CONTROL	LOCATION	WATTAGE	OUTPUT
PS - Power Supply, 120-277VAC	010V - 0-10V Dimming	D - Dry	96 - 96 W	24 - 24 VDC

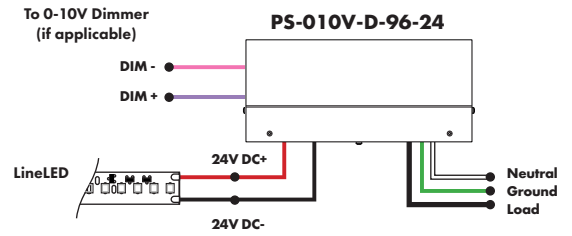

MODELS	96W
Length	8.29"
Width	4.10"
Depth	1.59"

Ordering Code Universal Dimming Power Supplies 1% 120VAC - 277VAC

MODEL	INPUT CONTROL	ENVIRONMENT	WATTAGE	OUTPUT
PS - Power Supply, 120-277VAC	UNI - 0-10V Dimming, Phase Dimming	D - Dry W - Wet	30 - 30 Watts 60 - 60 Watts 96 - 96 Watts 3x96 - 3x96 Watts	24 - 24 VDC

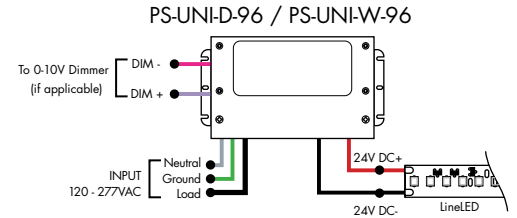

Compatibility: View a complete list of compatible dimmers on product page [Link](#)

0-10V - 1% dimming
MLV/ELV/TRIAC - 1% dimming, consult dimming compatibility chart

MODELS	PS-UNI-W-30W	PS-UNI-W-60W	PS-UNI-W-96W	PS-UNI-W-3X96W	PS-UNI-D-30W	PS-UNI-D-60W	PS-UNI-D-96W	PS-UNI-D-3X96W
Length	6.50"	7.40"	8.66"	11.85"	8.77"	8.77"	8.11"	9.94"
Width	3.73"	3.73"	3.73"	4.32"	4.27"	4.27"	5.60"	7.61"
Depth	1.61"	1.61"	1.61"	1.81"	1.83"	1.83"	1.83"	2.02"

Ordering Code Non-Dimming Power Supply 120VAC - 277VAC

MODEL	INPUT CONTROL	ENVIRONMENT	WATTAGE	OUTPUT
PS - Power Supply, 120-277VAC	ND - Non Dimming	D - Dry	96 - 96 Watts	24 - 24 VDC

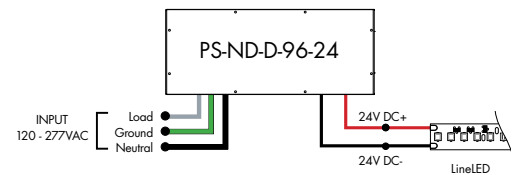

MODELS	96W
Length	14.40"
Width	5.20"
Depth	2.60"