

Features

- Extruded aluminum linear suspension system.
- 24VDC Class 2 fixtures made to order up to 232"
- Class 2 listed for damp locations
- Dot free even illumination with frosted lens
- Proprietary strong bond solder method handles up to 50 lbs of pull force on wire leads and connectors
- High Color Quality options offer premium quality and vibrant colors with R9 values up to 97
- High Efficacy options offer best in class output and efficacy with over 540 lm/ft and up to 76 lm/W
- 5 Year warranty

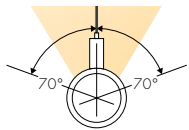

Fixture head rotates up to 140°, in either up or down direction. Reference ordering code for proper model

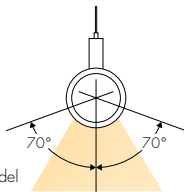

Finish Options (see page 2 for additional information)

- Silver Anodized
- White
- Aged Brass
- Black
- Matte Black
- Polished Gold
- Bronze
- Warm Nickel
- Chrome



Technical Information

MODEL	High Color Quality			High Efficacy				High Efficacy
	72SO	72HO	72VHO	HE48LO	HE48SO	HE48MO	HE48HO	HE64VHO
OUTPUT OPTIONS								
Lumens Output (3000K) <small>(with a Clear Lens)</small>	148 lm/ft	240 lm/ft	292 lm/ft	144 lm/ft	200 lm/ft	266 lm/ft	427 lm/ft	541 lm/ft
Average Power Consumption <small>(for a 4" section)</small>	2.8 W/ft	4.8 W/ft	6 W/ft	1.9 W/ft	2.8 W/ft	3.5 W/ft	6.5 W/ft	7.5 W/ft
Efficacy	53 lm/W	50 lm/W	49 lm/W	76 lm/W	71 lm/W	76 lm/W	66 lm/W	72 lm/W
Max Run Length <small>(in series)</small>	40 ft	31 ft	22 ft	48 ft	42 ft	33 ft	21 ft	15 ft
Max Ambient Temperature*	50°C [122°F]			50°C [122°F]				45°C [117°F]

*Max Ambient Temperature to maintain L70 of 50k+ hours. Exceeding Max Ambient Temperature may result in decreased life/output. Consult Technical Support for specific inquiries.

High Color Quality (72)

CCT	Multiplier <small>(reference - 3000K)</small>	TM-30			
		CRI	R _f	R _g	R ₉
1900K	0.55	96	94	97	90
2200K	0.70	96	95	101	89
2400K	0.72	98	97	101	91
2700K	0.74	97	96	101	91
3000K	1.00	97	95	104	97
3500K	1.02	97	94	105	97
4100K	1.07	97	90	99	97

High Efficacy (HE48/HE64)

CCT	Multiplier <small>(reference - 3000K)</small>	TM-30			
		CRI	R _f	R _g	R ₉
2200K	0.73	92	91	97	42
2500K	0.81	93	96	96	62
2700K	0.94	92	90	99	58
3000K	1.00	92	89	99	57
3500K	1.02	92	89	99	60
4000K	1.02	92	86	94	71

Ordering Code

MODEL	LENGTH ¹	OUTPUT	CCT	LENS ²	LIGHT DIRECTION	FINISH ^{3,4}
TEA - Teava Suspension	12" - 116" 1" increments	72SO - Standard 72HO - High 72VHO - Very High	19K-1900K 22K-2200K 24K-2400K 27K-2700K 30K-3000K 35K-3500K 41K-4100K	C - Clear F - Frosted	U - Up D - Down	SA - Silver Anodized BK - Black BZ - Bronze WH - White MBK - Matte Black WN - Warm Nickel AB - Aged Brass PG - Polished Gold ⁵ CH - Chrome ⁵
	12" - 116" 2" increments	HE48LO - low HE48SO - Standard HE48MO - Medium HE48HO - High HE64VHO - Very High	22K-2200K 25K-2500K 27K-2700K 30K-3000K 35K-3500K 40K-4000K			

1 - Custom lengths and increments are available, please consult Inside Sales with specific request.
 2 - All High Efficacy options can be used to comply with Title 24 JAB. High Color Quality options can be used to comply with Title 24 JAB depending on Output, CCT, and lens selections. See multiplier charts to calculate specific efficacies.
 3 - Non SA finishes may have extended lead times. Custom RALs are available, please consult Inside Sales with specific request.
 4 - White canopy included with all finishes except Black and Matte Black, which includes a Black canopy.
 5 - Polished Gold finishes have a maximum fixture length of 96", and Chrome finishes have a maximum fixture length of 144".

Product Dimensions

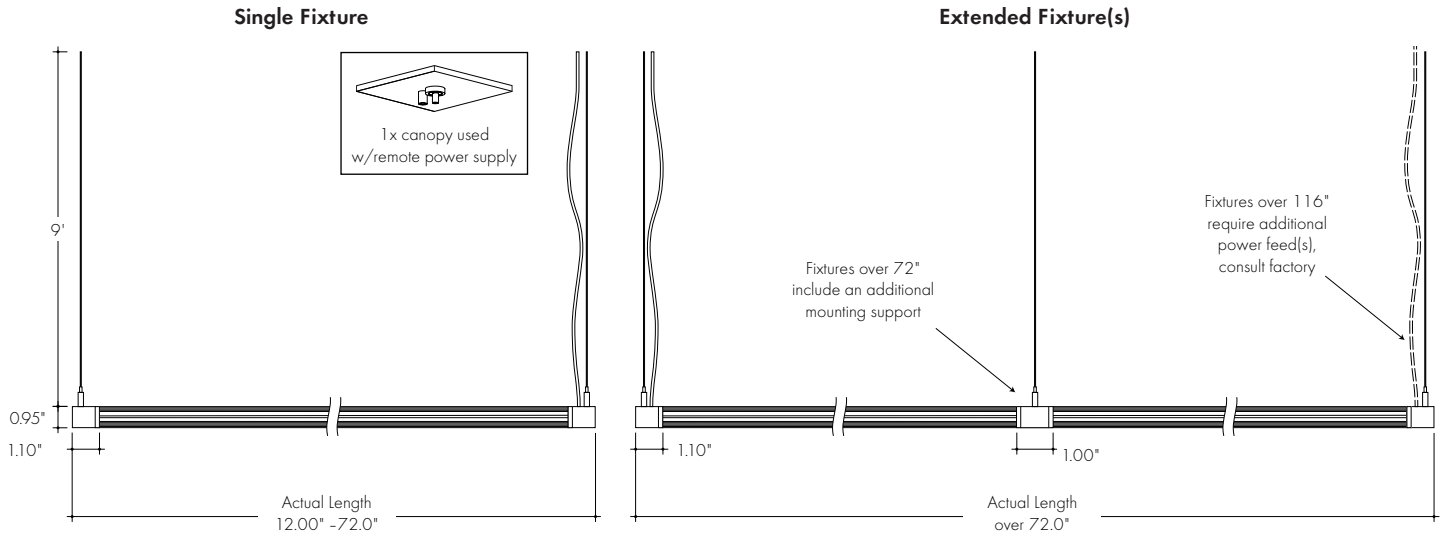

Finish Options

- Finish options are available in a wide variety, allowing for complete customization of style and aesthetic.
- Non Silver Anodized finishes may have extended lead times.
- Polished Gold finishes have a maximum fixture length of 96", and Chrome finishes have a maximum fixture length of 144".
- Custom RALs are available, please consult Inside Sales with specific request.

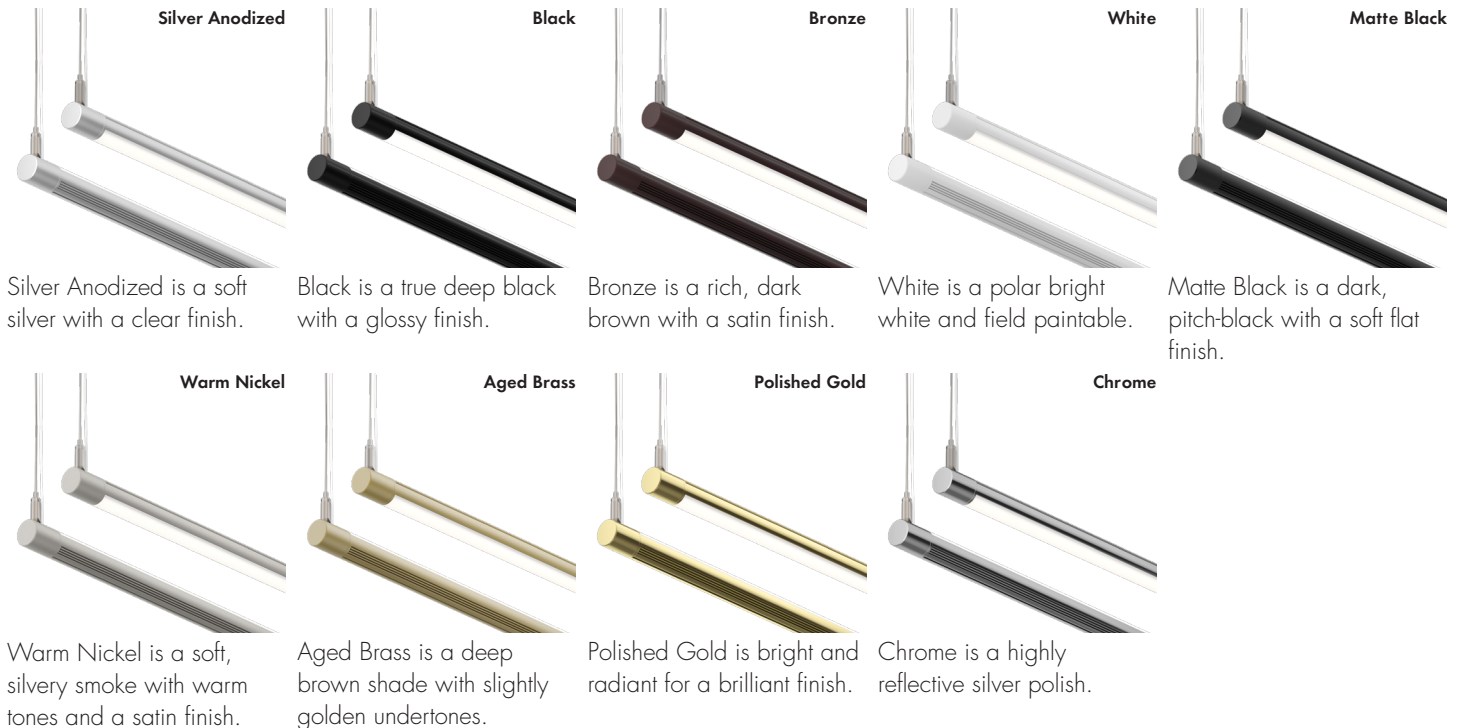

Light Transmission and Dotting

Output Options	Lens	
	Clear	Frosted
72SO	CD	ND
72HO	CD	ND
72VHO	CD	ND
HE48LO	CD	ND
HE48SO	CD	ND
HE48MO	CD	ND
HE48HO	CD	ND
HE64VHO	CD	ND
Transmission Percentage	100%	69%

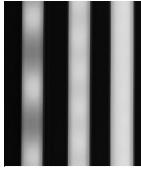

CD SD ND

CD - Clear Dotting
SD - Slight Dotting
ND - No Dotting

Photometry

TEA-48-72VHO-30K-C

Teava, 4ft, 3000K, VHO, Clear Lens

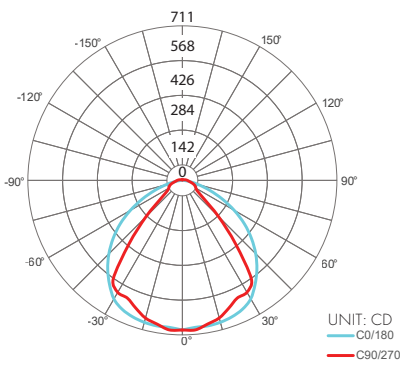

Zonal Lumen Summary 3000K

Zone	Lumen	% Fixture
0-30	542	32.0%
0-40	893	52.6%
0-60	1442	85.1%
0-90	1652	97.4%
0-180	1695	100.0%

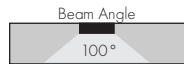

TEA-48-72VHO-30K-F

Teava, 4ft, 3000K, VHO, Frosted Lens

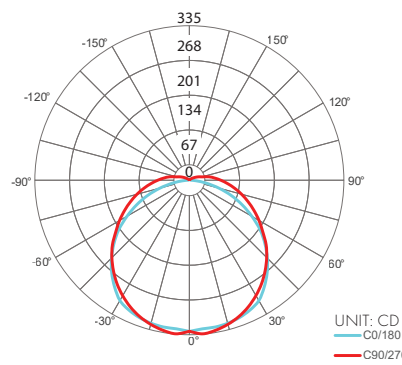

Zonal Lumen Summary 3000K

Zone	Lumen	% Fixture
0-30	258	22.0%
0-40	428	36.7%
0-60	784	67.1%
0-90	1095	93.7%
0-180	1169	100.0%

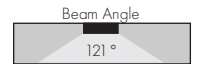

Power Consumption

Tested at Full Power with PDC Series power supplies.

Standard Nominal Lengths offered provide minimal shadowing. For alternate lengths, please consult Inside Sales with specific request.

High Color Quality (72)

Nominal Length (in)	Actual Length	Watts			Nominal Length (in)	Actual Length	Watts			Nominal Length (in)	Actual Length	Watts		
		SO	HO	VHO			SO	HO	VHO			SO	HO	VHO
12	11 1/16	2.7	4.4	6.2	47	46 15/16	10.0	16.7	22.1	82	81 11/16	17.9	28.9	37.6
13	12 3/16	2.7	4.4	6.2	48	—	—	—	—	83	82 13/16	18.1	29.2	38.0
14	13 6/16	2.7	4.4	6.2	49	48 1/16	10.2	17.1	22.6	84	84	18.3	29.5	38.4
15	14 8/16	2.7	4.4	6.2	50	49 4/16	10.5	17.4	23.1	85	—	—	—	—
16	15 11/16	2.9	4.8	6.7	51	50 6/16	10.7	17.8	23.5	86	85 2/16	18.5	29.8	38.8
17	16 13/16	3.1	5.2	7.3	52	51 9/16	11.1	18.6	24.4	87	86 5/16	18.7	30.1	39.2
18	18	3.4	5.6	7.8	53	52 11/16	11.4	18.9	24.9	88	87 7/16	19.2	30.8	40.0
19	—	—	—	—	54	53 14/16	11.6	19.3	25.3	89	88 10/16	19.4	31.1	40.4
20	19 2/16	3.6	6.0	8.3	55	—	—	—	—	90	89 12/16	19.6	31.5	40.8
21	20 5/16	3.9	6.5	8.9	56	55 1/16	11.9	19.7	25.7	91	90 15/16	19.9	31.8	41.1
22	21 7/16	4.4	7.3	9.9	57	56 3/16	12.1	20.1	26.1	92	—	—	—	—
23	22 10/16	4.6	7.7	10.5	58	57 6/16	12.3	20.5	26.6	93	92 1/16	20.1	32.2	41.5
24	23 12/16	4.8	8.1	11.0	59	58 8/16	12.8	21.3	27.4	94	93 4/16	20.4	32.5	41.9
25	24 15/16	5.1	8.6	11.5	60	59 11/16	13.1	21.6	27.8	95	94 6/16	20.6	32.9	42.3
26	—	—	—	—	61	60 13/16	13.3	22.0	28.3	96	95 9/16	21.1	33.6	43.1
27	26 1/16	5.3	9.0	12.1	62	62	13.6	22.4	28.7	97	96 12/16	21.3	33.9	43.4
28	27 4/16	5.6	9.4	12.6	63	—	—	—	—	98	97 14/16	21.5	34.2	43.8
29	28 6/16	5.8	9.8	13.1	64	63 2/16	13.8	22.8	29.1	99	—	—	—	—
30	29 9/16	6.2	10.5	14.1	65	64 5/16	14.0	23.1	29.6	100	99 1/16	21.8	34.6	44.2
31	30 11/16	6.5	10.9	14.5	66	65 7/16	14.5	23.8	30.5	101	100 3/16	22.0	34.9	44.6
32	31 14/16	6.7	11.2	15.0	67	66 10/16	14.7	24.1	31.0	102	101 6/16	22.2	35.2	45.0
33	—	—	—	—	68	67 12/16	14.9	24.4	31.4	103	102 8/16	22.5	35.9	45.9
34	33 1/16	6.9	11.6	15.5	69	68 15/16	15.1	24.7	31.9	104	103 11/16	22.7	36.2	46.3
35	34 3/16	7.1	12.0	16.0	70	—	—	—	—	105	104 13/16	22.9	36.5	46.7
36	35 6/16	7.3	12.3	16.5	71	70 1/16	15.3	25.0	32.4	106	106	23.1	36.8	47.1
37	36 8/16	7.8	13.1	17.4	72	71 4/16	15.5	25.4	32.8	107	—	—	—	—
38	37 11/16	8.0	13.4	17.9	73	72 6/16	15.8	25.7	33.3	108	107 2/16	23.3	37.1	47.5
39	38 13/16	8.2	13.8	18.4	74	73 9/16	16.2	26.3	34.2	109	108 5/16	23.5	37.4	48.0
40	40	8.4	14.2	18.9	75	74 11/16	16.4	26.6	34.7	110	109 7/16	23.9	38.1	48.8
41	—	—	—	—	76	75 14/16	16.6	26.9	35.1	111	110 10/16	24.1	38.4	49.2
42	41 2/16	8.7	14.5	19.3	77	—	—	—	—	112	111 12/16	24.3	38.7	49.6
43	42 5/16	8.9	14.9	19.8	78	77 1/16	16.8	27.3	35.5	113	112 15/16	24.5	39.0	50.0
44	43 7/16	9.3	15.6	20.7	79	78 3/16	17.1	27.6	35.9	114	—	—	—	—
45	44 10/16	9.6	16.0	21.2	80	79 6/16	17.3	27.9	36.3	115	114 1/16	24.8	39.3	50.4
46	45 12/16	9.8	16.4	21.7	81	80 8/16	17.7	28.5	37.2	116	115 4/16	25.0	39.6	50.8

Power Consumption

Tested at Full Power with PDC Series power supplies.

Standard Nominal Lengths offered provide minimal shadowing. For alternate lengths, please consult Inside Sales with specific request.

High Efficacy (HE48)

Nominal Length (in)	Actual Length	Watts				Nominal Length (in)	Actual Length	Watts				Nominal Length (in)	Actual Length	Watts			
		LO	SO	MO	HO			LO	SO	MO	HO			LO	SO	MO	HO
12	10 13/16	1.7	2.5	3.5	5.7	47	46 4/16	6.7	10.2	12.6	23.9	82	81 11/16	12.2	19.4	23.3	41.4
13	12 12/16	1.7	2.5	3.5	5.7	48	-	-	-	-	-	83	-	-	-	-	-
14	-	-	-	-	-	49	48 3/16	6.9	10.7	13.3	24.7	84	83 10/16	12.5	19.9	23.9	42.2
15	14 12/16	1.7	2.5	3.5	5.7	50	-	-	-	-	-	85	-	-	-	-	-
16	-	-	-	-	-	51	50 3/16	7.1	11.2	13.9	25.4	86	85 10/16	12.8	20.3	24.5	43.1
17	16 11/16	2.0	3.0	4.0	7.2	52	-	-	-	-	-	87	-	-	-	-	-
18	-	-	-	-	-	53	52 2/16	7.4	11.7	14.5	26.3	88	87 9/16	13.1	20.8	25.1	44.1
19	18 11/16	2.4	3.5	4.6	8.7	54	-	-	-	-	-	89	-	-	-	-	-
20	-	-	-	-	-	55	54 2/16	7.7	12.3	15.1	27.4	90	89 9/16	13.4	21.3	25.7	45.0
21	20 10/16	2.7	3.9	5.2	10.2	56	-	-	-	-	-	91	-	-	-	-	-
22	-	-	-	-	-	57	56 1/16	8.0	12.9	15.7	28.5	92	91 8/16	13.7	21.7	26.3	46.0
23	22 10/16	3.0	4.4	5.8	11.7	58	-	-	-	-	-	93	-	-	-	-	-
24	-	-	-	-	-	59	58 1/16	8.4	13.5	16.4	29.5	94	93 8/16	14.0	22.1	26.9	47.0
25	24 9/16	3.4	4.9	6.4	13.2	60	-	-	-	-	-	95	-	-	-	-	-
26	-	-	-	-	-	61	60	8.7	14.0	17.0	30.6	96	95 7/16	14.3	22.6	27.5	47.9
27	26 9/16	3.7	5.4	7.0	14.7	62	62	9.0	14.6	17.6	31.6	97	-	-	-	-	-
28	-	-	-	-	-	63	-	-	-	-	-	98	97 7/16	14.4	22.8	27.8	48.4
29	28 8/16	4.1	5.9	7.5	15.8	64	63 15/16	9.4	15.2	18.2	32.6	99	-	-	-	-	-
30	-	-	-	-	-	65	-	-	-	-	-	100	99 6/16	14.7	23.3	28.5	49.4
31	30 8/16	4.4	6.4	8.1	16.8	66	65 15/16	9.7	15.6	18.7	33.7	101	-	-	-	-	-
32	-	-	-	-	-	67	-	-	-	-	-	102	101 6/16	15.0	23.7	29.0	50.4
33	32 7/16	4.8	6.9	8.7	17.9	68	67 14/16	10.0	16.1	19.2	34.7	103	-	-	-	-	-
34	-	-	-	-	-	69	-	-	-	-	-	104	103 5/16	15.3	24.1	29.6	51.3
35	34 7/16	5.0	7.2	9.0	18.5	70	69 14/16	10.4	16.5	19.8	35.7	105	-	-	-	-	-
36	-	-	-	-	-	71	-	-	-	-	-	106	105 5/16	15.6	24.6	30.2	52.3
37	36 6/16	5.4	7.7	9.6	19.5	72	71 13/16	10.7	17.0	20.3	36.7	107	-	-	-	-	-
38	-	-	-	-	-	73	-	-	-	-	-	108	107 4/16	15.8	25.0	30.7	53.2
39	38 6/16	5.7	8.2	10.2	20.6	74	73 13/16	11.0	17.4	20.8	37.7	109	-	-	-	-	-
40	-	-	-	-	-	75	-	-	-	-	-	110	109 4/16	16.1	25.5	31.3	54.2
41	40 5/16	6.0	8.7	10.8	21.5	76	75 12/16	11.3	17.9	21.4	38.7	111	-	-	-	-	-
42	-	-	-	-	-	77	-	-	-	-	-	112	111 3/16	16.4	25.9	31.9	55.2
43	42 5/16	6.2	9.2	11.4	22.3	78	77 12/16	11.6	18.4	22.0	39.6	113	-	-	-	-	-
44	-	-	-	-	-	79	-	-	-	-	-	114	113 3/16	16.7	26.4	32.5	56.1
45	44 4/16	6.4	9.7	12.0	23.1	80	79 11/16	11.9	18.9	22.7	40.5	115	-	-	-	-	-
46	-	-	-	-	-	81	-	-	-	-	-	116	115 2/16	17.0	26.8	33.1	57.0

Power Consumption

Tested at Full Power with PDC Series power supplies.

Standard Nominal Lengths offered provide minimal shadowing. For alternate lengths, please consult Inside Sales with specific request.

High Efficacy (HE64)

Nominal Length (in)	Actual Length	Watts	Nominal Length (in)	Actual Length	Watts	Nominal Length (in)	Actual Length	Watts
		VHO			VHO			VHO
12	10 8/16	7.6	47	46 13/16	27.6	82	81 11/16	49.8
13	12	7.6	48	–	–	83	–	–
14	13 8/16	7.6	49	48 6/16	28.2	84	83 3/16	50.4
15	–	–	50	49 14/16	29.5	85	84 11/16	51.7
16	15 1/16	7.6	51	–	–	86	–	–
17	16 9/16	8.9	52	51 6/16	30.1	87	86 3/16	52.3
18	–	–	53	52 14/16	31.4	88	87 12/16	53.6
19	18 1/16	9.5	54	–	–	89	–	–
20	19 9/16	10.7	55	54 7/16	32.0	90	89 4/16	54.2
21	–	–	56	55 15/16	33.3	91	90 12/16	55.5
22	21 2/16	11.4	57	–	–	92	–	–
23	22 10/16	12.6	58	57 7/16	34.0	93	92 4/16	56.2
24	–	–	59	58 15/16	35.2	94	93 12/16	57.5
25	24 2/16	13.2	60	–	–	95	–	–
26	25 10/16	14.5	61	60 7/16	36.5	96	95 5/16	58.2
27	–	–	62	62	37.2	97	96 13/16	59.5
28	27 2/16	15.1	63	–	–	98	–	–
29	28 11/16	16.4	64	63 8/16	38.4	99	98 5/16	60.1
30	–	–	65	–	–	100	99 13/16	61.4
31	30 3/16	17.0	66	65	39.1	101	–	–
32	31 11/16	18.2	67	66 8/16	40.4	102	101 6/16	62.0
33	–	–	68	–	–	103	102 14/16	63.2
34	33 3/16	18.9	69	68 1/16	41.0	104	–	–
35	34 12/16	20.1	70	69 9/16	42.3	105	104 6/16	63.8
36	–	–	71	–	–	106	105 14/16	65.0
37	36 4/16	20.7	72	71 1/16	42.9	107	–	–
38	37 12/16	22.0	73	72 9/16	44.2	108	107 7/16	65.6
39	–	–	74	–	–	109	108 15/16	66.8
40	39 4/16	22.6	75	74 2/16	44.9	110	–	–
41	40 13/16	23.9	76	75 10/16	46.1	111	110 7/16	67.4
42	–	–	77	–	–	112	111 15/16	68.5
43	42 5/16	24.5	78	77 2/16	46.7	113	–	–
44	43 13/16	25.7	79	78 10/16	48.0	114	113 7/16	69.6
45	–	–	80	–	–	115	115	70.1
46	45 5/16	26.4	81	80 2/16	48.6	116	–	–

Voltage Drop Calculator

The below chart assumes nominal voltage of 24 Volts and a Voltage Drop Allowance of 3% through the wire

Wattage [W]	Wire Length From Power Supply to Start of Run [ft]						
	12 AWG	14 AWG	16 AWG	18 AWG	20 AWG	22 AWG	24 AWG
5	1088.2	684.4	430.3	270.6	170.2	107.1	67.3
10	544.1	342.2	215.1	135.3	85.1	53.5	33.7
15	362.7	228.1	143.4	90.2	56.7	35.7	22.4
20	272.0	171.1	107.6	67.7	42.6	26.8	16.8
25	217.6	136.9	86.1	54.1	34.0	21.4	13.5
30	181.4	114.1	71.7	45.1	28.4	17.8	11.2
35	155.5	97.8	61.5	38.7	24.3	15.3	9.6
40	136.0	85.5	53.8	33.8	21.3	13.4	8.4
45	120.9	76.0	47.8	30.1	18.9	11.9	7.5
50	108.8	68.4	43.0	27.1	17.0	10.7	6.7
55	98.9	62.2	39.1	24.6	15.5	9.7	6.1
60	90.7	57.0	35.9	22.6	14.2	8.9	5.6
65	83.7	52.6	33.1	20.8	13.1	8.2	5.2
70	77.7	48.9	30.7	19.3	12.2	7.6	4.8
75	72.5	45.6	28.7	18.0	11.3	7.1	4.5
80	68.0	42.8	26.9	16.9	10.6	6.7	4.2
85	64.0	40.3	25.3	15.9	10.0	6.3	4.0
90	60.5	38.0	23.9	15.0	9.5	5.9	3.7
96	56.7	35.6	22.4	14.1	8.9	5.6	3.5

Power Supplies

See Power Supply instructions and spec sheet for wiring information. For a complete list of compatible dimmers, see Compatible Dimming Chart on the Resources page.

Universal Power Supply 1% 120VAC - 277VAC

MODEL	POWER	OUTPUT
PDCU-D - IP20 Dry Series	30 - 30 W 60 - 60 W 96 - 96 W 3X96 - 3X96 W	24 - 24 VDC
PDCU-W - IP66 Wet Series	96 - 96 W 3X96 - 3X96 W	

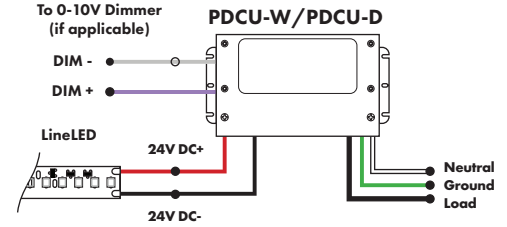

0-10V dims down to 1%, MLV/ELV/TRIAC dims down to 1%.
For a complete list of compatible dimmers, see [Compatible Dimming Chart](#) on the Resources page.

MODELS	PDCU-W 96W	PDCU-W 3X96W	PDCU-D 30W	PDCU-D 60W	PDCU-D 96W	PDCU-D 3X96W
Length	8.66"	11.85"	6.10"	7.93"	8.25"	9.57"
Width	3.73"	4.32"	3.35"	3.35"	4.10"	5.94"
Depth	1.61"	1.81"	1.33"	1.32"	1.56"	1.13"

0-10V Dimming Power Supplies 0.1% 120VAC - 277VAC

MODEL	POWER	OUTPUT	DIMMING
PS010V - 0-10V Power Supply dims down to 0.1%	96 - 96 Watt 3X96 - 3 X 96 Watt	24 - 24 VDC	LIN - Linear LOG - Logarithmic

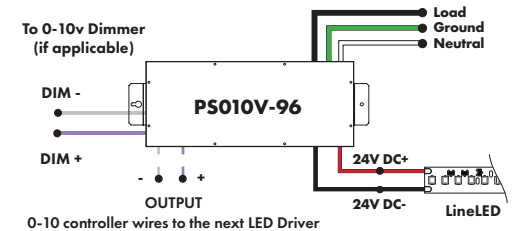

MODELS	96W	3X96
Length	14.40"	15.75"
Width	5.20"	6.62"
Depth	2.60"	4.95"

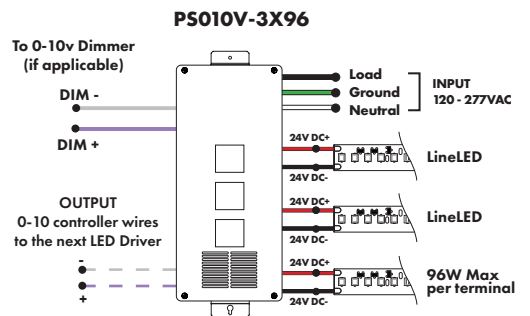

Triac, MLV, & ELV Compatible Dimmers

MODEL	POWER	OUTPUT
PDC - (IP20) Power Supply	96 - 96 Watts	24 - 24 VDC

MODELS	96W
Length	8.25"
Width	4.10"
Depth	1.56"

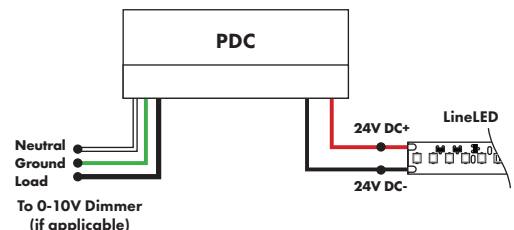

Power Supplies

See Power Supply instructions and spec sheet for wiring information. For a complete list of compatible dimmers, see Compatible Dimming Chart on the Resources page.

DMX Dimming Power Supplies 120VAC - 277VAC

MODEL	POWER	OUTPUT
PSDMX - DMX Power Supply dims down to 0%	96 - 96 Watt 3X96 - 3 X 96 Watt	24 - 24 VDC

Features eldoLED's LINEARdrive configurable dimmable drivers

MODELS	96W	3X96
Length	14.40"	15.75"
Width	5.20"	6.62"
Depth	2.60"	4.95"

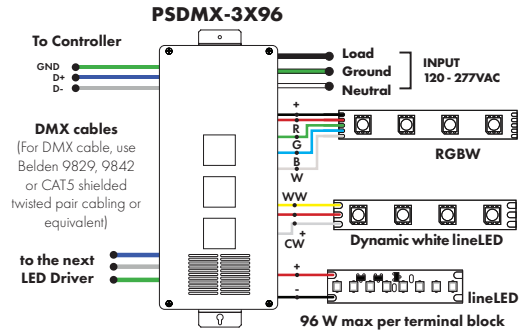
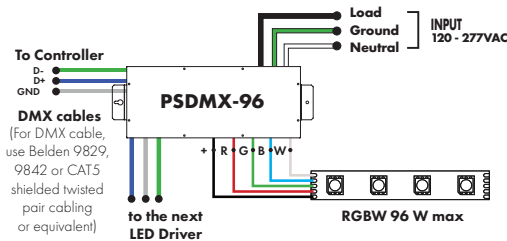

DALI 0% Dimming Power Supplies 120VAC - 277VAC

MODEL	POWER	OUTPUT
PSDALI - DALI Power Supply dims down to 0%	96 - 96 Watt 3X96 - 3 X 96 Watt	24 - 24 VDC

Features eldoLED's LINEARdrive configurable dimmable drivers

Model	96W	3X96
Length	14.40"	15.75"
Width	5.20"	6.62"
Depth	2.60"	4.95"

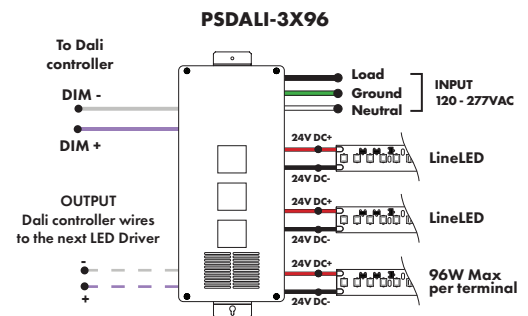
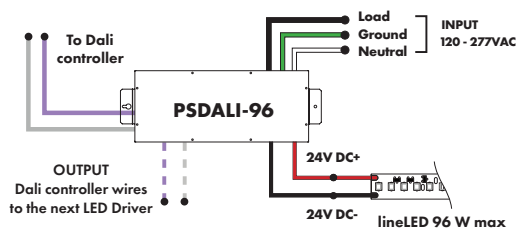

Enlighted Enabled Dimming Power Supplies 120VAC - 277VAC

MODEL	POWER	OUTPUT	DIMMING	LOCATION
PSV - PSV Series	96 - 96 Watt	24 - 24 VDC	ENL - Enlighted Dimming dims down to 0%	D - Damp

Model	96W
Length	14.40"
Width	5.20"
Depth	2.60"

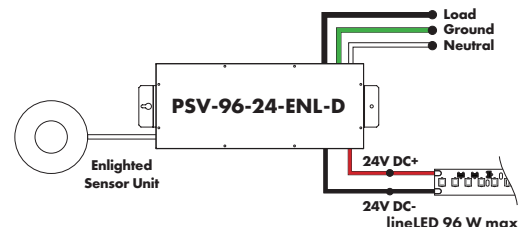

Power Supplies

See Power Supply instructions and spec sheet for wiring information. For a complete list of compatible dimmers, see Compatible Dimming Chart on the Resources page.

Non-Dimming Power Supply 120VAC - 277VAC

MODEL	POWER	OUTPUT	DIMMING	LOCATION
PSV - PSV Series	96 - 96 Watt	24 - 24 VDC	U2ND - Non Dimming	D - Damp

MODELS	96W
Length	14.40"
Width	5.20"
Depth	2.60"

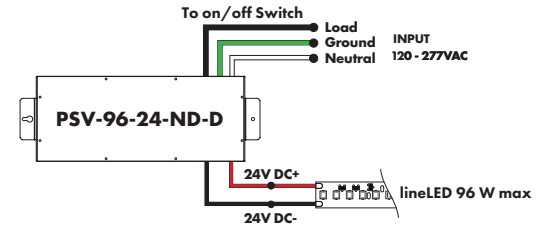

Luminii is a Lutron OEM Advantage Partner

Lutron Power Supplies 1%

MODEL	MODEL
LTEA4U1UKL-CV240	L3DA4U1UKL-CV240

Lutron - HiLume™ 1% 2-wire LED Driver
40W max

HiLume™ 1% EcoSystem Voltage LED driver
40W max

(120V forward phase only)

MODELS	LTEA4U1UKL-CV240	L3DA4U1UKL-CV240
Length	4.89"	4.98"
Width	4.00"	4.00"
Depth	2.62"	2.62"

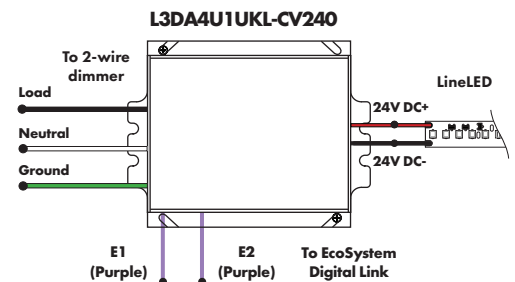
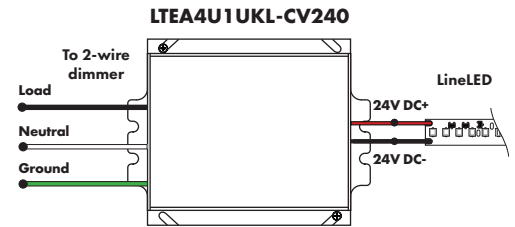

Luminii is a Lutron OEM Advantage Partner

Lutron Power Supplies 0.1%

MODEL
L3D0-96W24V-U

HiLume™ 0.1% EcoSystem Voltage LED Driver with Soft-On, Fade-to-Black™
96W max

MODELS	L3D0
Length	10.50"
Width	5.50"
Depth	2.00"

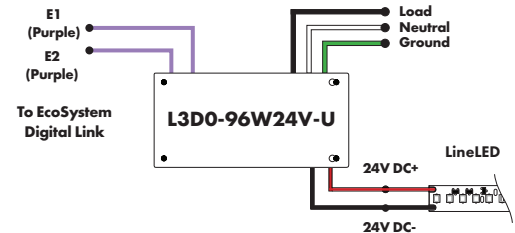

In-Ground Power Supplies

MODEL	POWER	OUTPUT	INPUT
IG - In ground CVE Series	CVE - ELV Dimming DALI - eidoLED Dali dimming Both dims down to 0%	96X2 - 2 X 96 Watt	24 - 24 VDC
			Blank - 120 V 277 - 240/277 V

MODELS	Dual Circuit
Length	8.40"
Width	8.30"
Depth	8.10"

