

Features

- Recessed track supports Stenos directional and ambient modules
- Minimalist and narrow track seamlessly integrates into environments
- Two channel track allows independent dim control for groups of modules when paired with appropriate power supplies
- Snap-in Electrical Joiners include magnetic black/white Cover Plates to maintain clean aesthetic.
- Custom drawing and approval is required for every STENOS Track System prior to order acceptance.
- 24 VDC Class 2 power supply
- 4A max on track
- 96W max on track per power supply
- For ceiling thicknesses from 0.375" up to 1.25"
- Dry location only

Finish Options

- Black powder coated
- White powder coated



Product Dimensions

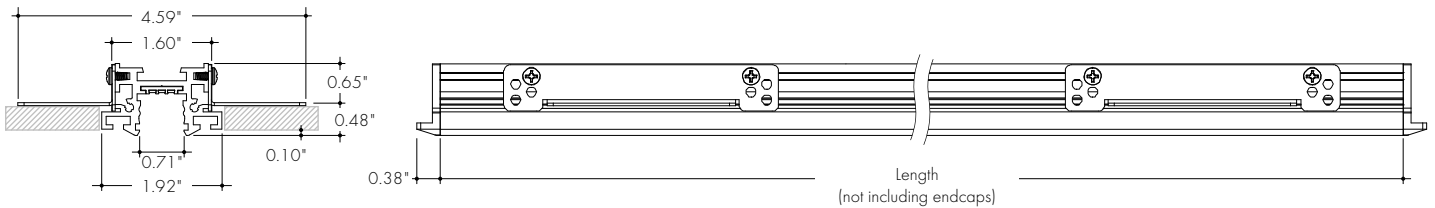

Straight Run

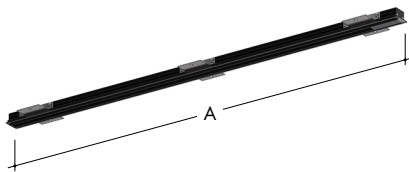

L Shape

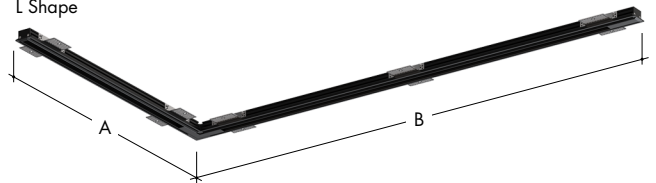

U Shape

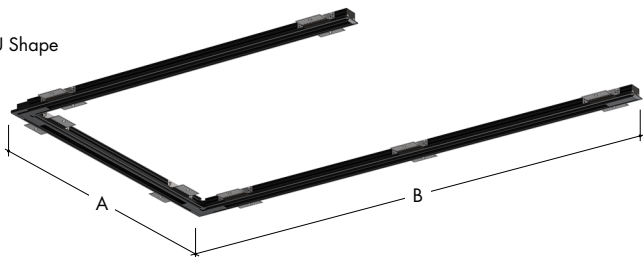

Rectangle Shape

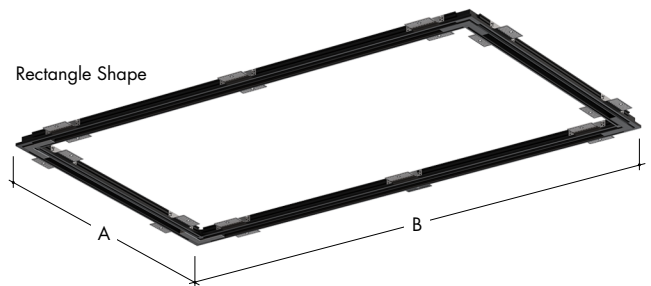

Ordering Code

example: STL-R-40-BK-UNV-240-C-XXXXXX

MODEL ¹	SHAPE	OVERALL LENGTH ²	FINISH	POWER SUPPLY ³	WATTAGE	SERIAL NUMBER
STL - Stenos Recessed Trimless Track	S - Straight Run R - Rectangle Shape L - L Shape U - U Shape	- Overall run length of system/shape (rounded up to the nearest foot)	BK - Black WH - White	2CHDMX - 2 Channel DMX, 0.1%, PSDMX DWDT8 - Dynamic White, DALI DT8, 0.1%, PSDALI-DT8 DW010V - Dynamic White 0-10V, 0.1%, PS010VD-W2C WD010V - Warm Dim Curve (with Dynamic White Module), 0-10V, 0.1%, PS010VD-WW DWDT8-AWNR - Dynamic White, DALI DT8 with Lutron Athena, 0.1%, PSDALI-DT8-AWNR WD010V-AWNR - Warm Dim Curve (with Dynamic White Module), 0-10V with Lutron Athena, 0.1%, PS010VD-WW-AWNR	- Watts (rounded up to the nearest Watt, see Wattage Calculation Guide, next page)	Serial Number, entered by Luminii

1- Custom drawing and approval is required for every STENOS Track System prior to order acceptance. Allow 2 weeks (typical) for custom drawing generation/confirmation process. Use STENOS Track System Sketch Grid to convey as many details as possible including: shape, dimension of each leg, desired location of power feeds, and location of track modules (Directional, Ambient, Track Heads).
 2- Mechanical joiners are required for sections longer than 12ft.
 3- Power supplies are 120-277 VAC input, unless otherwise noted.

Product Dimensions

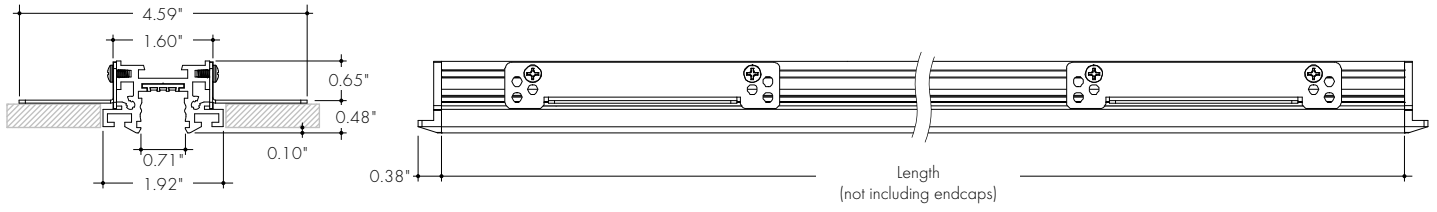

Stenos Track with Directional Module and Louver

Stenos Track with Ambient Module and Louver

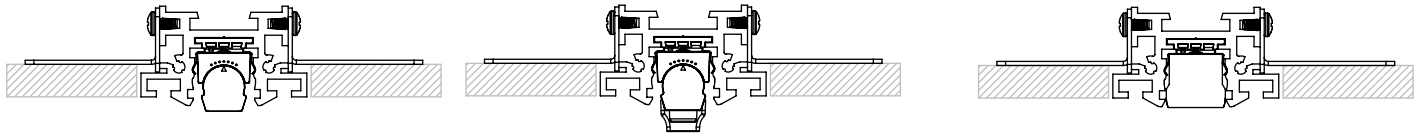

Wattage Calculation Guide

Stenos Track Module	Wattage	Lumens (3000K)	Length	Reference
STENOS 3" Directional Module	2.6 W	250 lm	2.5 in	
STENOS 5" Directional Module & STENOS 5" Wall Wash Module	5.4 W	520 lm 275 lm	4.8 in	
STENOS 12" Directional Module & STENOS 12" Wall Wash Module	13.0 W	1260 lm 665 lm	11.8 in	
STENOS 1" Track Head Long 15° optic Regressed Baffle	6.6 W	565 lm	4.9 in	
STENOS 1" Track Head Short 15° optic Regressed Baffle	5.2 W	458 lm		
STENOS 24" Ambient Module SO	5.5 W	475 lm	24.4 in	
STENOS 24" Ambient Module HO	12.3 W	1000lm	24.4 in	
STENOS 48" Ambient Module SO	11.0 W	950 lm	48.0 in	
STENOS 48" Ambient Module HO	24.7 W	2025 lm	48.0 in	

Wattage Calculation Guide (Example)

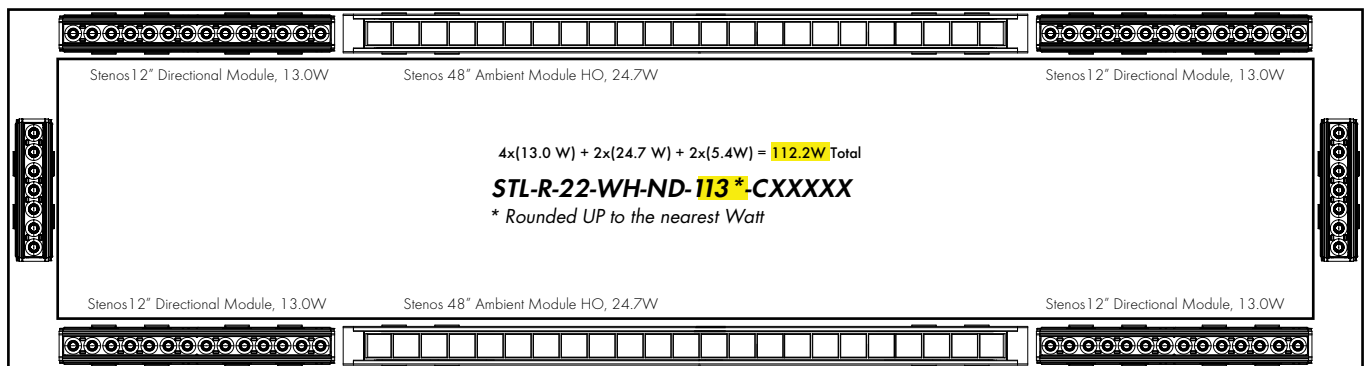

Factory Built Sections

Straight Run

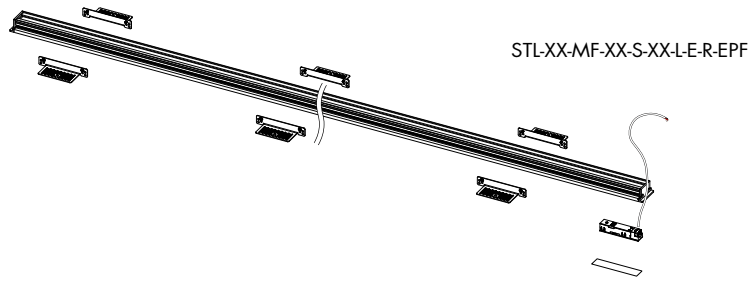

L Shape

STL-XX-MF-XX-L-XX-L-E-R-CHL

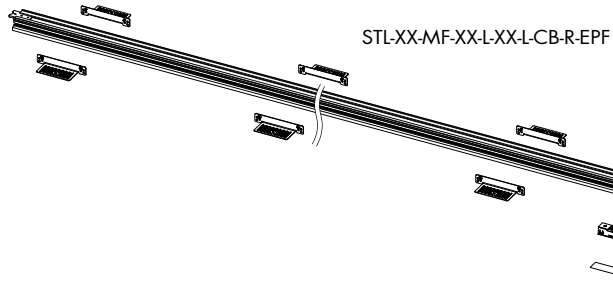
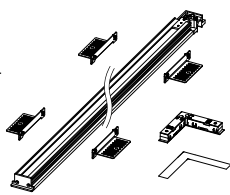

U Shape

STL-XX-MF-XX-U-XX-L-CB-R-CHL

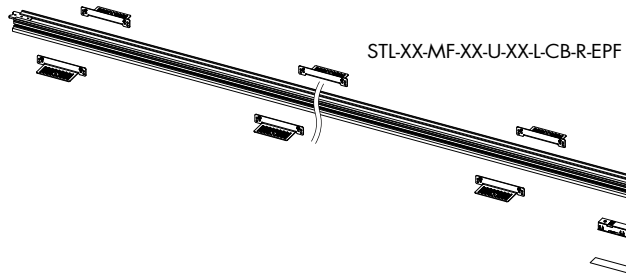
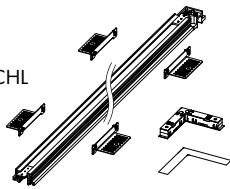

STL-XX-MF-XX-U-XX-L-E-R-CHL

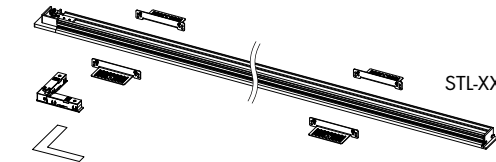

Rectangle Shape

STL-XX-MF-XX-R-XX-L-CB-R-CHL

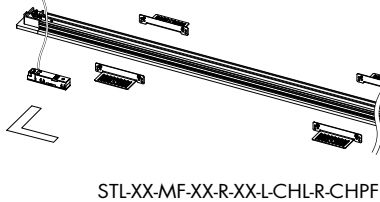
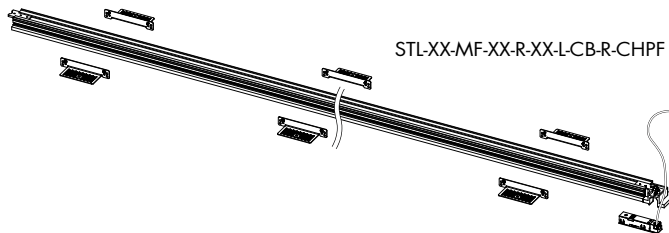
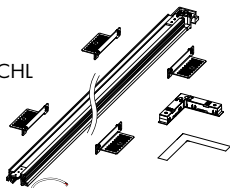

STL-XX-MF-XX-R-XX-L-CB-R-CB

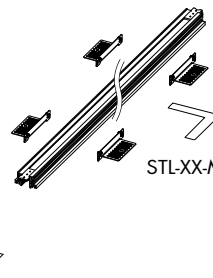

Power Supplies

See Power Supply instructions and spec sheet for wiring information. For a complete list of compatible dimmers, see Compatible Dimming Chart on the Resources page.

Dynamic White Control

-2CHDMX

2 CHANNEL DMX, 0.0%, 120-277VAC, PSDMX

MODELS	96W
Length	14.40"
Width	5.20"
Depth	2.60"

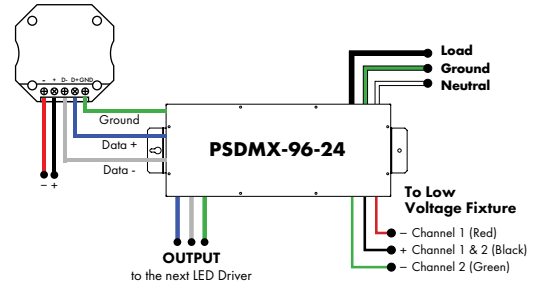

-DWDT8

DYNAMIC WHITE, DALI DT8, 0.1%, PSDALI-DT8

MODELS	96W
Length	14.40"
Width	5.20"
Depth	2.60"

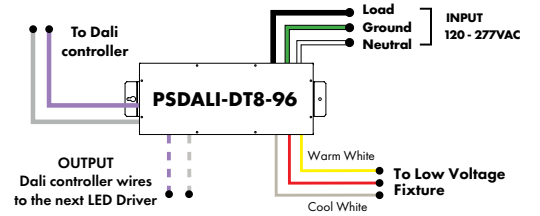

-DW010V

DYNAMIC WHITE 0-10V, 0.1%, PSV010-W2C, PS010VD-W2C

MODELS	96W
Length	14.40"
Width	5.20"
Depth	2.60"

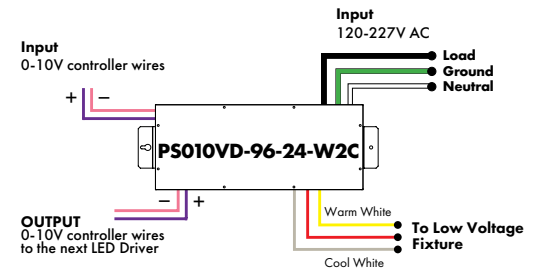

Warm Dim Control (With Dynamic White Module)

-WD010V

WARM DIM CURVE (WITH DYNAMIC WHITE MODULE), 0-10V, 0.1%, PS010VD-WW

MODELS	96W
Length	14.40"
Width	5.20"
Depth	2.60"

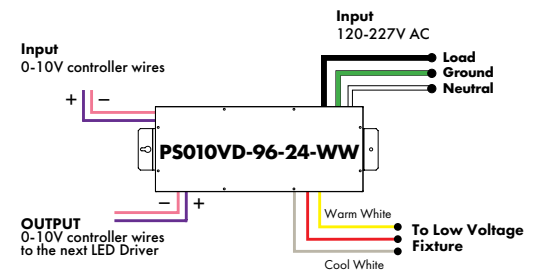
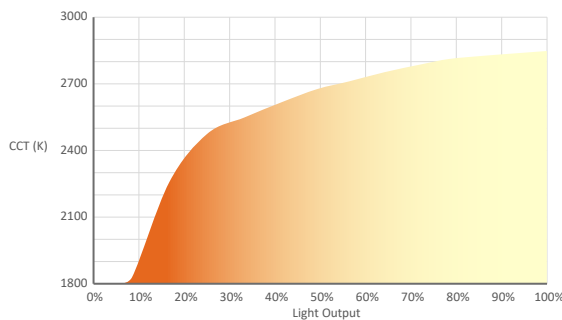

Track Components (for field configurable systems)

To minimize voltage drop, it is recommended to not exceed 24ft of track per power feed or 3 track joiners per power feed.

EC-STL-H3-XX
Recessed Trimless End Caps

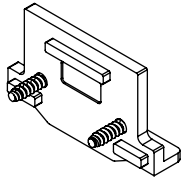

Blank End Cap for ending a Recessed Trimless run

JOIN-M-ST
Mechanical Joiner Brackets

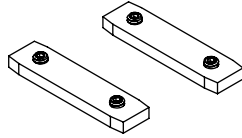

Used for mechanically joining adjacent Track sections

TC-96-XX
Track Cover, 96"

TC-144-XX
Track Cover, 144"

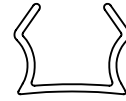

Track Covers ship complete with Recessed Trimless Track and cover unoccupied sections of track. They are field cuttable and can be used to protect channel during the mudding process. Additional can be ordered, if necessary.

JOIN-M-L-STL-XX
Recessed Trimless Mechanical L Joiner

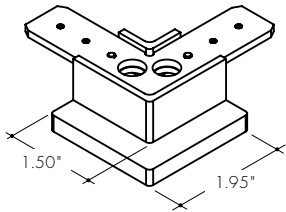

For creating a 90deg in-plane corner

JOIN-M-W-STL-XX
Recessed Trimless Mechanical Wall to Ceiling Joiner

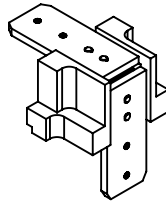

For creating a 90deg Wall to Ceiling corner

MB-STL
Mounting Bracket, Hanger Bar or Threaded Rod

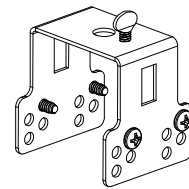

Hanger bars ordered separately. Threaded rod and nuts not included

STL-48/96/144-MF/MB-XX
StenosTrimless Track, Recessed

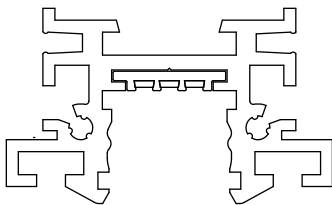

PF-HB-ALL
Hanger Bars for use with MB-STL Mounting Bracket

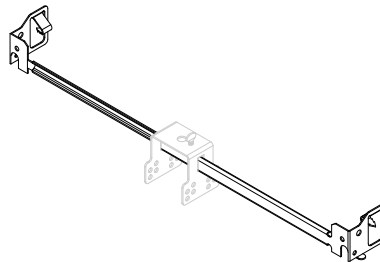

For use to mount to joists. MB-STL not included.

XX	Color
WH	White
BK	Black

Track Components

To minimize voltage drop, it is recommended to not exceed 24ft of track per power feed or 3 track joiners per power feed.

ST-JOIN-E-P

Electrical Power Feed, with black and white Cover Plates

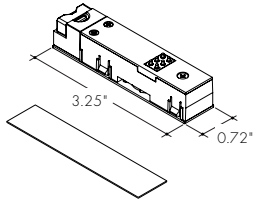

For use with 18AWG field wires with max outer diameter 0.3" (cable and power feed do not ship pre-assembled)

ST-JOIN-E-P-72

Electrical Power Feed, 72" Plenum Cable

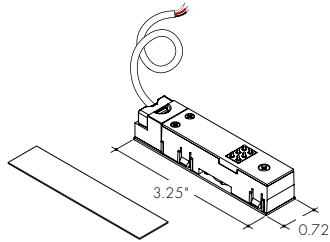

with Black and White cover plates (cable and power feed do not ship pre-assembled)

ST-JOIN-E-S

Electrical Joiner, Straight, with black and white Cover Plates

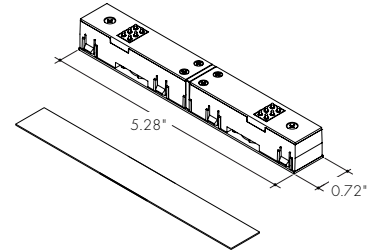

For electrically joining adjacent Track sections

ST-JOIN-E-L

Electrical Joiner, L with black and white Cover Plates

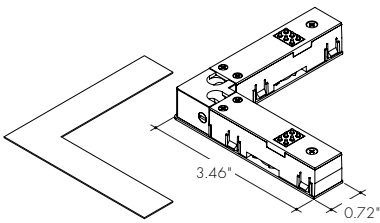

For for use with Mechanical L Joiner

ST-JOIN-E-F

Electrical Joiner, Flexible with black and white Cover Plates

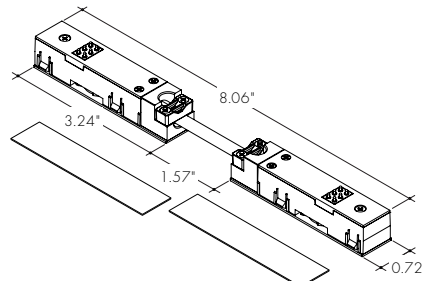

For use with Mechanical L Joiner or Wall to Ceiling Joiner

Wiring and Multiple Channels

For **single channel** use, connect black and white power feed wires.

For **two channel** use, connect per wiring diagram in the Two Channel Control section of power supplies

For **Dynamic White** use, connect per wiring diagram in the Dynamic White section of power supplies

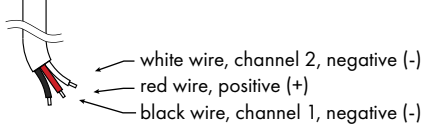
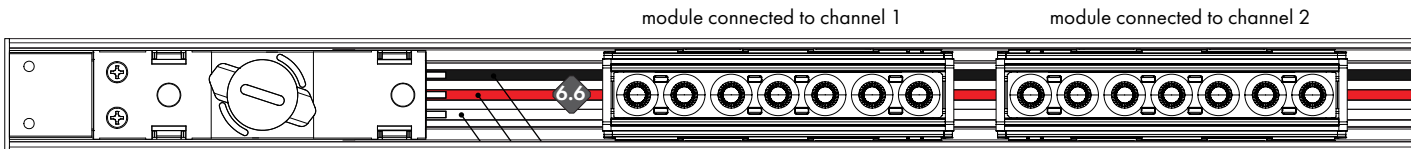

channel 1, negative (-), power cord black wire
positive (+), power cord red wire
channel 2, negative (-), power cord white wire

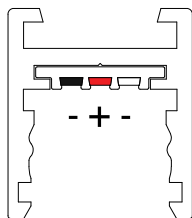

rotate module 180°, if connecting to other channel

negative (-)
positive (+)

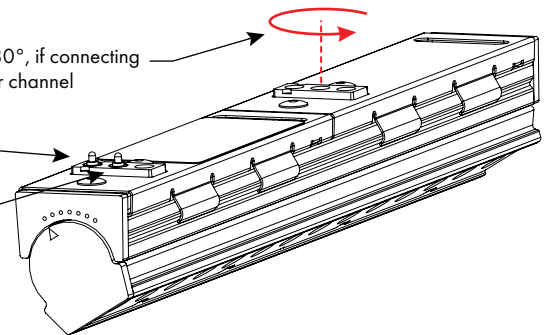

The Power Track contains three copper conductors allowing two channel control .

- Center conductor is common positive (+), connected to power cord red wire
- One outer conductor is channel 1 negative (-), connected to power cord black wire
- Other outer conductor is channel 2 negative (-), connected to power cord white wire

Select control channel for Stenos Directional and Ambient Modules by rotating them 180°

For **two channels** use, connect per wiring diagram in the Two Channel Control section of power supplies
For **single channel** use, connect black and white power feed wires.



For single channel use, connect black and white wires

STENOS Track System Sketch Grid

Use grid below to sketch out details of the STENOS Track System. Include as many details as possible such as:

- Shape
- Dimensions of each leg
- Location of Power Feeds
- Location and Type of Track Modules (Directional, Ambient, Track Heads)
- Ceiling Thickness (for Trimless Tracks)

Note: 96W max, 24ft max,
and 3 electrical joiners max
per power feed
See example on next page

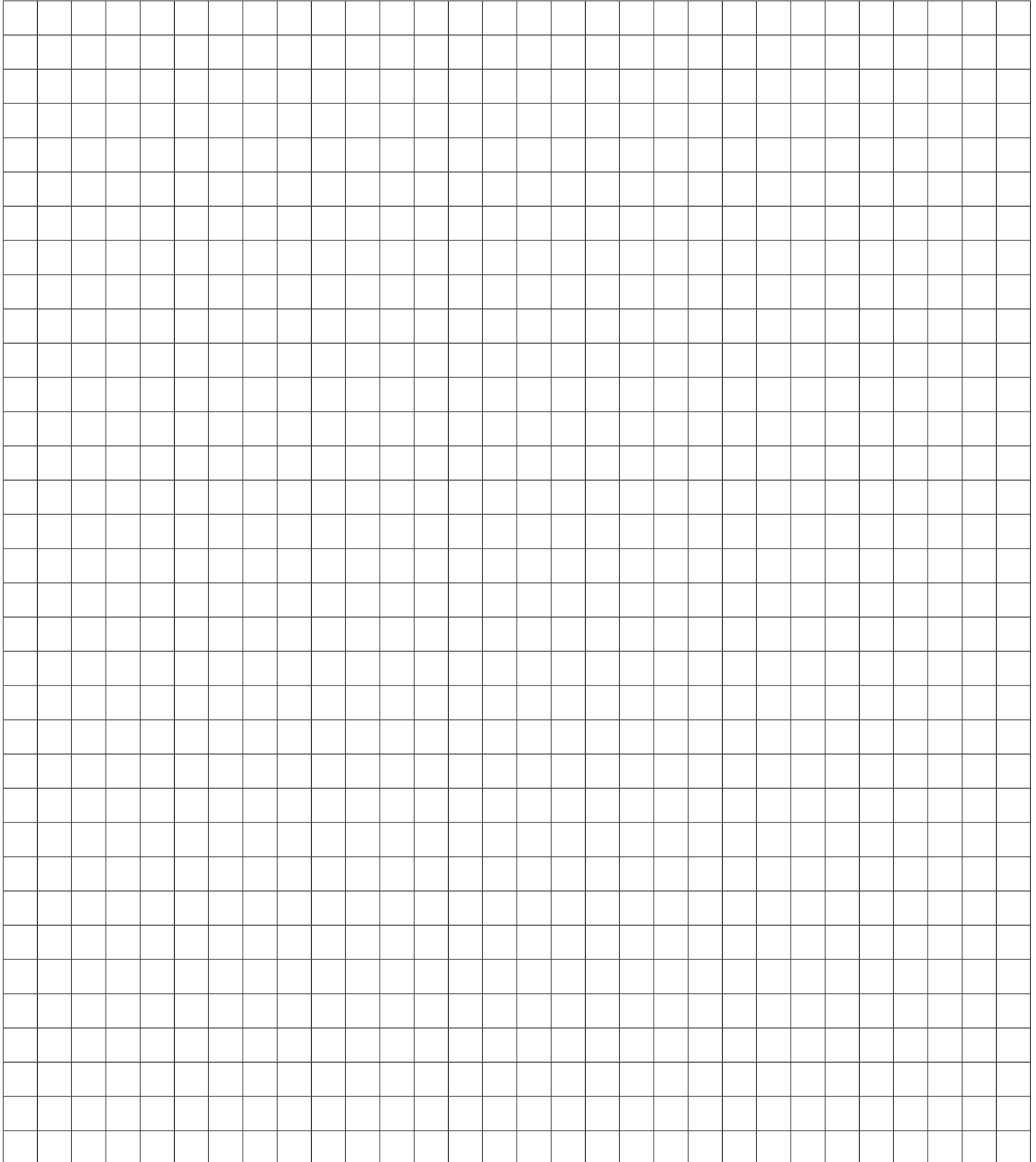

STENOS Track System Sketch Grid (Example)

Use grid below to sketch out details of the STENOS Track System. Include as many details as possible such as:

- Shape
- Dimensions of each leg
- Location of Power Feeds
- Location and Type of Track Modules (Directional, Ambient, Track Heads)
- Ceiling Thickness (for Trimless Tracks)

Note: 96W max, 24ft max, and 3 electrical joiners max per power feed

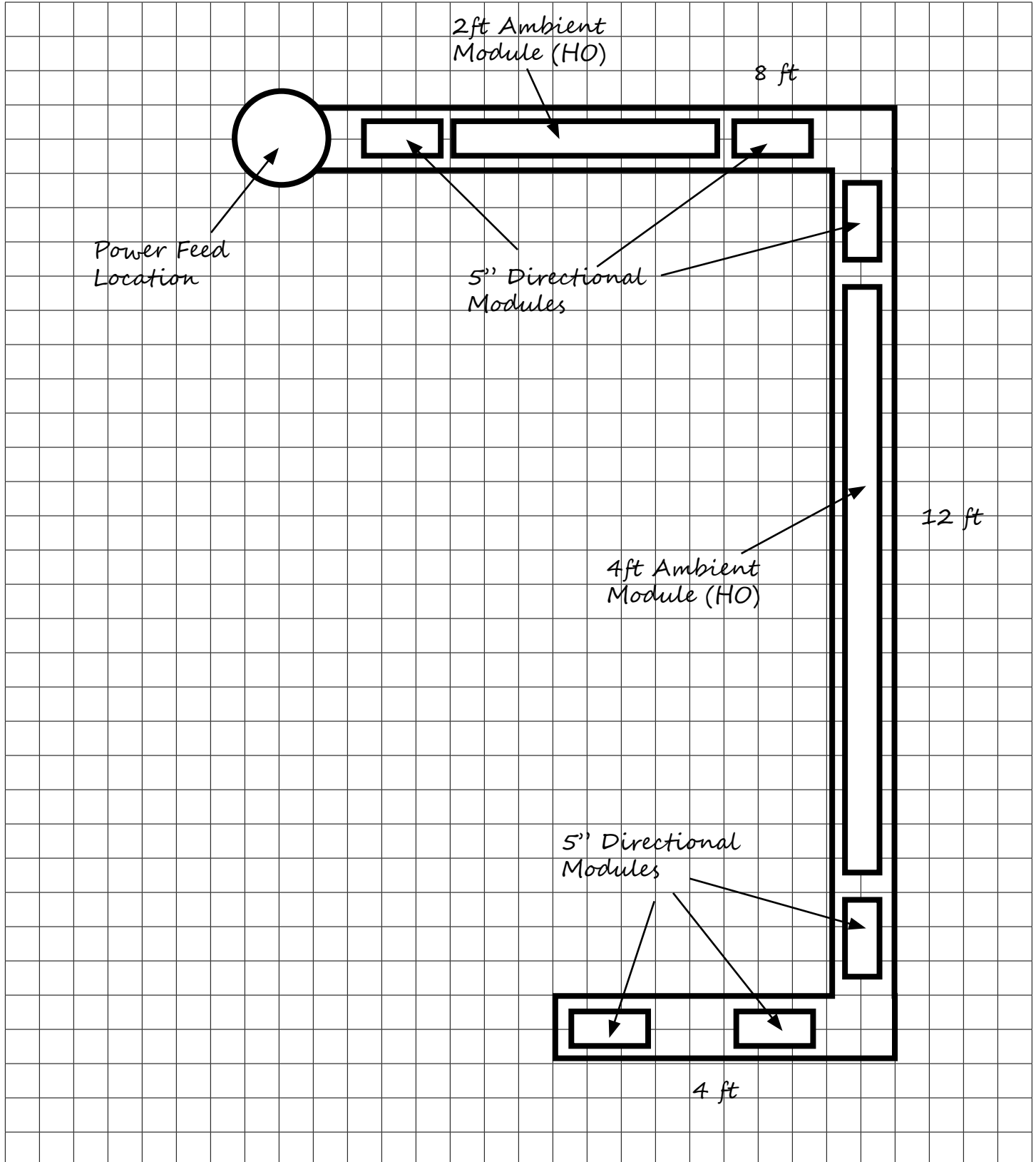

Additional Stenos Products



(left to right)
Stenos Recessed Deep Trimless Track
Stenos Recessed Trimless Track
Stenos Recessed Trimmed Track
Stenos Surface Mount Track
Stenos Suspended Track



Stenos Directional Module

Stenos Directional Module with Louver

Stenos Directional Module with Wall Wash

Stenos Ambient Module

Stenos Ambient Module with Louver

