

Features

The RO1.5 Channel is a linear aluminum extrusion that has been designed to fit many LED lighting needs. Mounting bracket option allow for great flexibility in any application; from fixed installations like a closet rod light fixture. Substantial aluminum mass in profile provides excellent heat sink for high power LEDs. RO1.5 extrusion comes with two choices of optical lenses. Extrusion and lenses are field cuttable.

Finish

Silver anodized, White, Black, Bronze

Mounting

Multiple mounting brackets

Diffuser Lens

Polycarbonate, snap-in-place, UV resistant

Product Dimensions

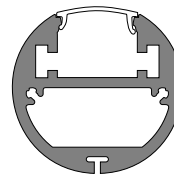
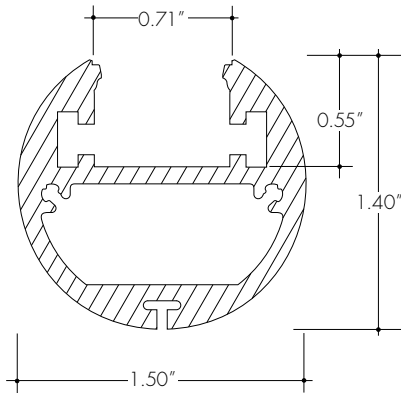

RO1.5 with Clear Lens

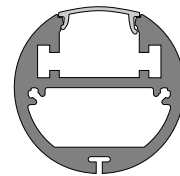

RO1.5 with Frosted Lens

Lens Options	
Actual Length	-118"
Available Lenses	- Clear - Frosted

Ordering code

MODEL	LENGTH	LENS	FINISH ²
RO15 - RO1.5 Channel	118 - 118" ¹	C - Clear F - Frosted	SA - Silver Anodized WH - White BK - Black BZ - Bronze

1 - For Channels and lenses over 90", incremental shipping charges will apply.

2 - Non SA finishes may have extended lead times. Custom RALs are available, please consult Inside Sales with specific request.

All accessories sold separately.

Mounting Brackets

MC-R3
Silver Anodized Mounting Clip

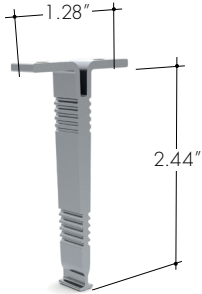

MC-R3-XX
Mounting Clip

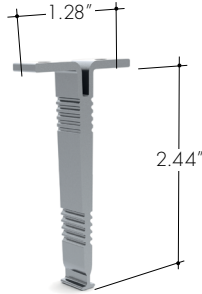

XX	Color
WH	White
BK	Black
BZ	Bronze

MC-RO15-MF-XX
End support

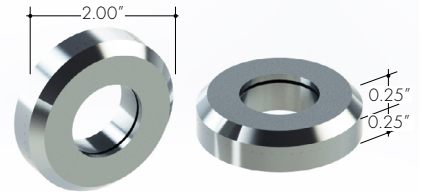

XX	Color
SA	Silver Anodized
WH	White

End Caps

EC-RO15-H3-XX
Endcap



EC-RO15-H5-XX
Endcap with powerfeed opening

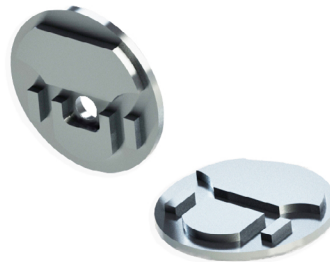

XX	Color
SA	Silver Anodized
WH	White
BK	Black
BZ	Bronze

