

Plexineon Suspended Mount

RGB, RGBW and RGBW Pixel

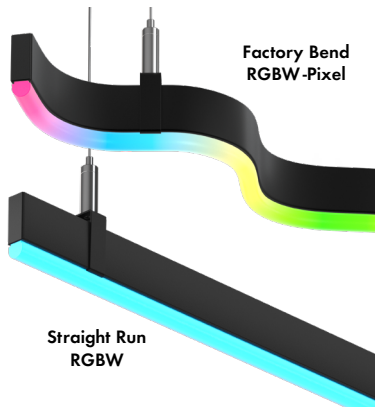

- Easy to install, for interior accent lighting
- Neon look providing a crisp, clear line of light visible for miles
- Creative freedom to make stunning designs, rigid construction maintains factory formed shape
- Mounting Clips and aircraft cable are included in the appropriate quantities
- Operating Temperature: -40° F to 140° F (-40° C to 60° C)
- 24VDC Class 2
- IK10 and 3G rated
- IP67 rated. IP68 rating available upon specific request
- 5 year warranty indoor, 3 year warranty outdoor

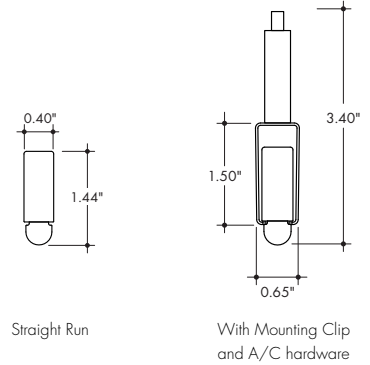

Technical Information

MODEL	Plexineon RGB	Plexineon RGBW	Plexineon Pixel RGBW
OUTPUT OPTIONS	SO		
Lumens Output <small>(all channels full on)</small>	72 lm/ft	110 lm/ft	84 lm/ft
Average Power Consumption <small>(for a 4" section)</small>	4.1 W/ft	5.4 W/ft	5.7 W/ft
Efficacy	17.5 lm/W	20.3 lm/W	14.7 lm/W
Cut Increment	1.97"	3.94"	3.94"
Max Run Length <small>(in series)</small>	32 ft	17 ft	16 ft
SPI Protocol	N/A	N/A	UCS 2904
DMX Addresses Occupied	N/A	N/A	4-channels per pixel

RGBW (3000K)				
Model	TM-30			
	CRI	R _f	R _g	R _b
RGBW	85	84	98	22
RGBW-PXSPI	85	84	98	22

Dominant Wavelength	
Color	RGB
Red	622nm
Green	525nm
Blue	468nm

Ordering Code

MODEL	RUN LENGTH ¹	BEND	CCT	OUTPUT	LENS	MOUNTING ³	FINISH	POWERFEED POSITION/TYPE	QUOTE NUMBER ⁵
PX-Plexineon	—Run length in inches, 6" min, no max run length	SR-Straight Run EB-Factory Bend, Side/Easy Bend ²	RGB- RGB RGBW- RGBW (3000K) RGBW-PXSPI- RGBW Pixel Contro (3000K)	SO- Standard	F- Frosted	SP- Suspension Mount, Standard Clips SPD- Suspension Mount, Decorative Clips ⁴	GG- Gloss Grey BK- Matte Black GY- Matte Grey WH- Matte White	B-4- Male Quick Connect One End, Female Quick Connect Other End	(Leave Blank) - For SR or FB -Quote Number entered by Inside Sales used for Factory Bends and Custom Drawings

1. RGB is available in 2" increments. RGBW and Pixel RGBW are available in 4" increments, +/- 1/2" tolerance. Run lengths over 96" (8ft) will be made of equal sections no longer than 96".
 2. Factory Bends require an Image or Drawing input at time of Quote to calculate total linear/arc length. Factory Bends require a Custom Drawing submittal at time of Order. Allow 2 weeks (typical) for Custom Drawing generation/confirmation process.

3. Standard mounting clip included approximately every 30" of linear/arc length.
 4. Decorative Clips match the fixture finish, included approximately every 18" of linear/arc length.
 5. Quote Number correlates the Quote to the Custom Drawing. If a single Quote includes different designs having the same length, add -1, -2, -3, etc. to the end of the Quote Number for each unique configuration.

Plexineon Suspended Mount

RGB, RGBW and RGBW Pixel



Corner Dimensions

HC-SR
Horizontal Corner

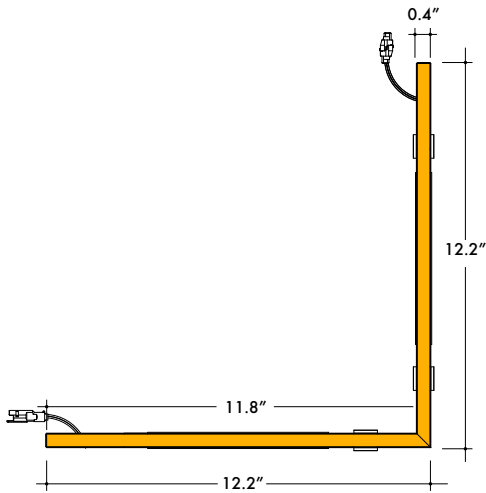

Ordering Code

MODEL	CORNER ¹	CCT	OUTPUT	LENS	MOUNTING ¹	FINISH	POWERFEED POSITION/TYPE
PX - Plexineon	HC-SR - Horizontal Corner	RGB - RGB RGBW - RGBW (3000K) RGBW-PXSPI - RGBW Pixel Control (3000K)	SO - Standard	F - Frosted	SP - Suspension Mount, Standard Clips SPD - Suspension Mount, Decorative Clips ²	GG - Gloss Grey BK - Matte Black GY - Matte Grey WH - Matte White	B-4 - Male Quick Connect One End, Female Quick Connect Other End

1. Corners include 3 mounting clips.
2. Decorative Clips match the fixture finish.

Plexineon Suspended Mount

RGB, RGBW and RGBW Pixel



Finish Options

BK
Matte Black Finish



WH
Matte White Finish



GY
Matte Grey Finish

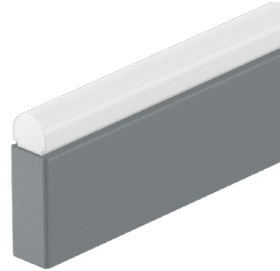

GG
Gloss Grey Finish

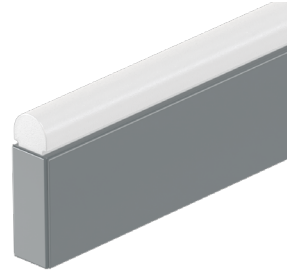

Suspension Hardware

- Suspension Hardware is included with Plexineon runs in the appropriate quantity, every 30" of linear/arc length
- Standard Clips have a stainless steel finish, Decorative Clip finishes match the fixture finishes
- Canopy Finishes come in White.

SP/SPD

SC-1MP2-SCL-0X
Suspension Kit with Single Clip,
Ø2.0" canopy, 150" A/C Cable

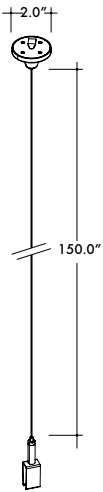

Used approximately every 30" of linear/arc length

SC-1MP2-DCL-0X
Suspension Kit with Joiner Clip,
Ø2.0" canopy, 150" A/C Cable

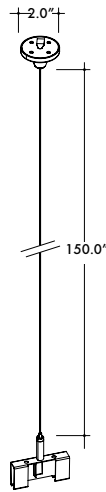

Use to join two fixtures together in the middle of a Suspended Run

SC-1FC5-SCL-CX-0X
Powerfeed Canopy Suspension Kit with
Single Clip, Ø5.0" canopy, 150" A/C Cable

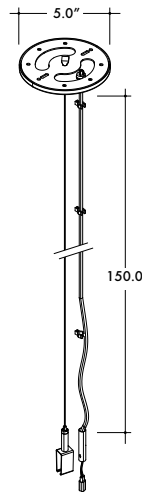

Used at the start of every Suspended Run

SC-1FC5-DCL-CX-0X
Powerfeed Canopy Suspension Kit with Joiner
Clip, Ø5.0" canopy, 150" A/C Cable

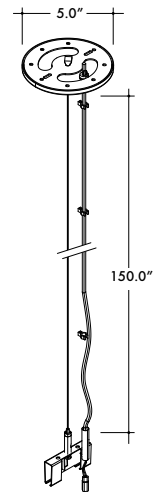

Used to join two fixtures together and to drop power in the middle of a Suspended Run

CX	Connector Type
C4	For RGB
C5	For RGBW
C3	For Pixel

0X	Clip Finish	Canopy Finish
00	Stainless Steel	<input type="checkbox"/> White
01	Matte Black	<input type="checkbox"/> White
02	Matte Grey	<input type="checkbox"/> White
03	<input type="checkbox"/> Matte White	<input type="checkbox"/> White

Plexineon Suspended Mount

RGB, RGBW and RGBW Pixel



Powerfeed and Connectors

For use with RGB

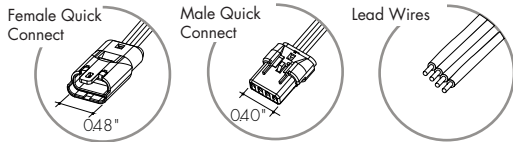

60-H-C4-0001-01
Female RGB Quick Connect
with 6" flying leads

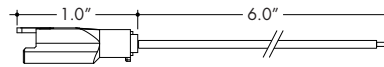

Female Quick Connect with flying leads can be connected to the Power Supply at the start of a run. Can also be used with the Male Quick Connect to make wire jumpers.

60-H-C4-0002-01
Male RGB Quick Connect
with 6" flying leads

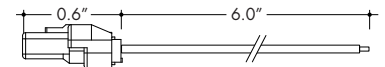

Male Quick Connect with flying leads can be used to make wire jumpers.

For use with RGBW

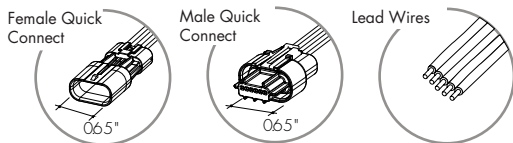

60-H-C5-0001-01
Female RGBW Quick Connect
with 6" flying leads

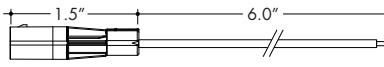

Female Quick Connect with flying leads can be connected to the Power Supply at the start of a run. Can also be used with the Male Quick Connect to make wire jumpers.

60-H-C5-0002-01
Male RGBW Quick Connect
with 6" flying leads

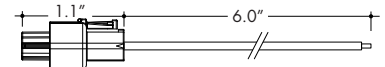

Male Quick Connect with flying leads can be used to make wire jumpers.

For use with Pixel

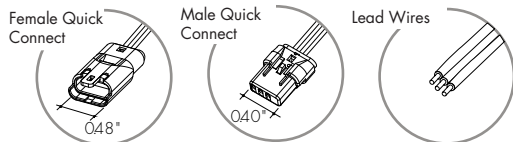

60-H-C3-0001-01
Female Pixel Quick Connect
with 6" flying leads

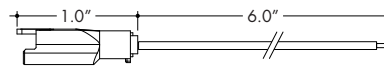

Female Quick Connect with flying leads can be connected to the Power Supply at the start of a run. Can also be used with the Male Quick Connect to make wire jumpers.

60-H-C3-0002-01
Male Pixel Quick Connect
with 6" flying leads

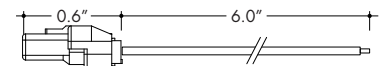

Male Quick Connect with flying leads can be used to make wire jumpers.

Also available with longer Flying Leads

60-H-C3-0005-01
Female Pixel Quick Connect
with 384" flying leads

Also available with longer Flying Leads

60-H-C3-0006-01
Male Pixel Quick Connect
with 384" flying leads

Additional Material

60-12-22AWGSBWN
Weatherproof Wire Nut
Silicone Filled

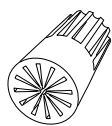

Order 2 per Power Supply.

55-STW02-050-00
50 ft of 14 gauge wire Black jacket,
2 conductors

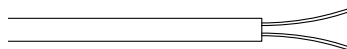

Sunlight, moisture resistant, and flame retardant PVC jacket per UL 1277

70-TOL02-001-01
Mounting Clip Installation Tool

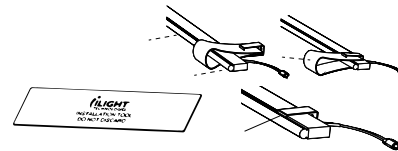

Use for installation of Plexineon into Mounting Clips

Plexineon Suspended Mount

RGB, RGBW and RGBW Pixel

Sample Layout

PX-120-EB-RGBW-PXSPI-SO-F-SP-GG-B-4-QXXXXX

Plexineon Factory Bend, Suspended Mounting Clips

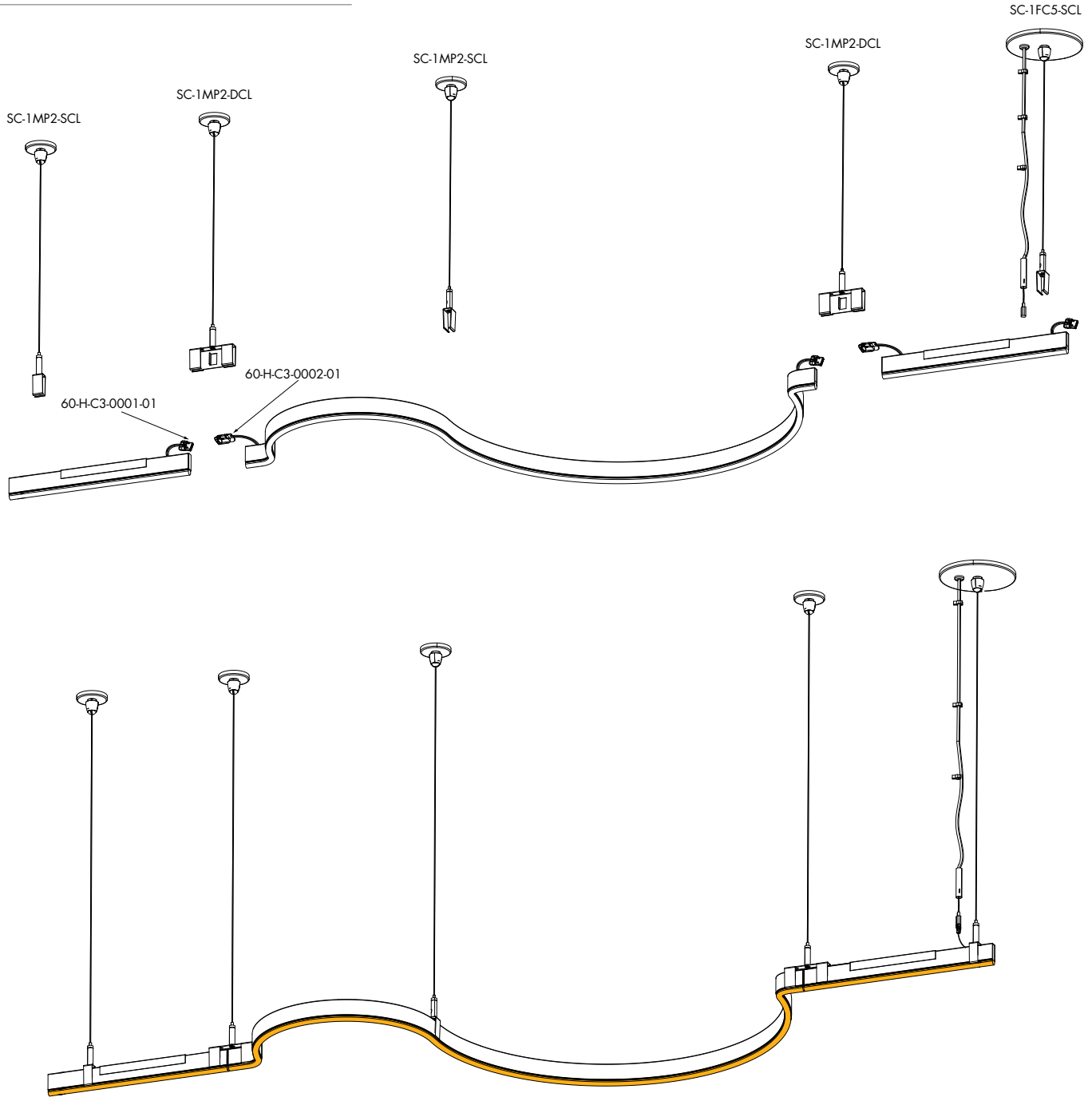

Plexineon Suspended Mount

RGB, RGBW and RGBW Pixel

Factory Bends

- Require Custom Drawing submittal and approval.

EB

Factory Bend, Side/Easy Bend

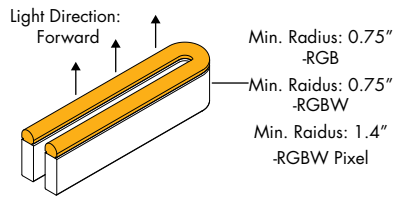

Plexineon Suspended Mount

RGB, RGBW and RGBW Pixel



Common Applications

Custom Indoor Designs | Coves | Signs | Building Facades | Lobbies | Hallways | Statement Pieces | Restaurants
Corporate Offices | Schools | Residential Towers | Parking Garages | Hotels | Bridges | Benches | Airports



Plexineon Suspended Mount

RGB, RGBW and RGBW Pixel



Power Supplies

See fixture and power supply instructions & spec sheet for wiring information. Dimming possible in select models - view Luminii website for list of compatible dimmers.

For use with RGB/RGBW/Pixel

Non-Dimming Power Supply 120VAC - 277VAC

MODEL	POWER	OUTPUT	DIMMING	LOCATION
PSV-PSV Series	96-96 Watt	24-24 VDC	ND-Non Dimming	D-Dry location

Requires a controller and a decoder to work properly

MODELS	96W
Length	8.25"
Width	4.10"
Depth	1.56"

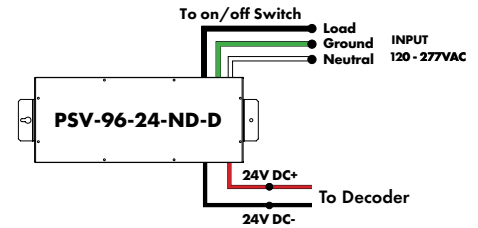

For use with RGB/RGBW

DMX 0% Dimming Power Supplies 120VAC - 277VAC

MODEL	POWER	OUTPUT
PSDMX-DMX Power Supply dims down to 0%	96 - 96 Watt 3X96 - 3 X 96 Watt	24-24 VDC

Features eldoLED's LINEARdrive configurable dimmable drivers.

DDMX-RGBW DMX Decoder not required when purchasing this power supply.

MODELS	96W	3X96
Length	14.40"	15.75"
Width	5.20"	6.62"
Depth	2.60"	4.95"

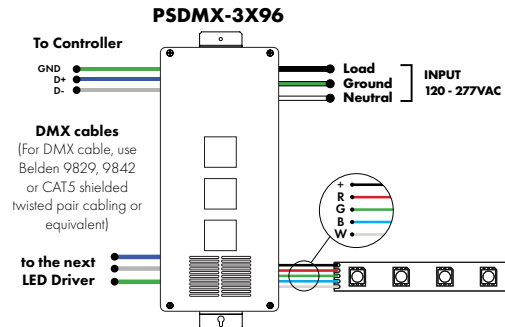
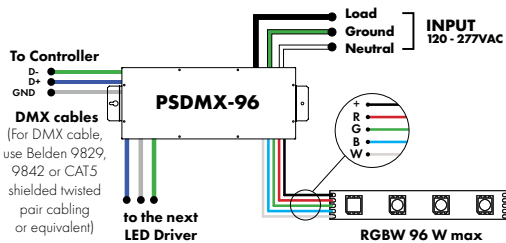



DMX-1Z-RGBW, DMX-3Z-RGBW

RGBW LED 1 or 3 Zone Controller



ORDERING CODE

MODEL	ZONES	COLOR
DMX - DMX Controller	3Z - Three Zone 1Z - One Zone	RGBW - Red, Green, Blue, & White

DMX /Wireless RGB-W wall-mount controller controls DMX lighting fixtures, wireless control of RGB-W lighting fixture or use both simultaneously. Fits in any standard US switch box. Includes all the outputs in the back of the controller.

Control brightness levels with a single touch, personalize and memorize 3 different scenes, and even create 3 variations of white.

Features

- 2 in 1 in-Wall Controller: DMX Control or Wireless RGB-W
- 65,000 Color Options, Dimming and Speed Control
- Memory Function
- 50 Foot Wireless Range
- Easily Fits Standard US Switch Boxes
- Touch Sensitive Glass Surface
- Includes 10 Built in Programs, or Create and Play Your Own

Operating Voltage

12 - 24V DC

Color Parameters

- Brightness
- Saturation
- Primary colors
- Fading
- Color changing speed

Touch DMX Controller

Touchscreen digital LED controller

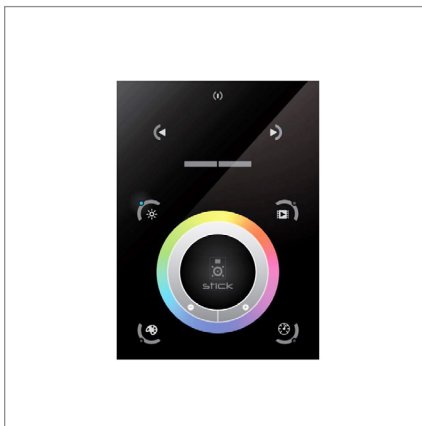

ORDERING CODE

MODEL
TSDMX-E

TSDMX-E - Touchscreen DMX controller

Programmable advanced DMX512 lighting controller featuring a touch-screen interface. Operates as stand alone controller or integrated with most architectural lighting control systems. Can controller endless DMX512 enabled devices.

Mounts to standard single or dual gang wall box with the included power supply inside the junction box. Terminal block design for power and data connections.

Features

- Sleek glass design which sits 0.43" from the wall
- Graphical color display to show selected environment
- Color/dimmer/speed palette
- Color temperature mixing
- Touch sensitive buttons. No mechanical parts
- Touch sensitive wheel allows for accurate color selection
- Multi-zone microSD memory
- Multi-room control with 500 scenes, 10 zones
- 1024 DMX channels. Control 340 RGB fixtures
- USB & Ethernet connectivity for programming and control

Power Supply

7 VDC (included)

Programmability

PC, Mac, Tablet, Smartphone

Output Signal

DMX512 (1024 channels)

Color Parameters

- Brightness
- Saturation
- Speed of color changing sequence
- Fading / dimming / brightness

DMX Decoder

DMX signal to RGBW decoder (required to operate DMX controller)

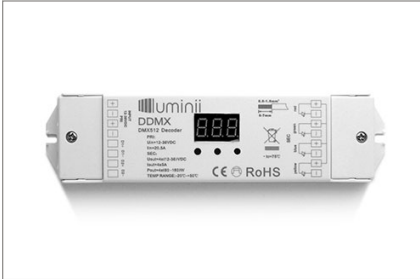

ORDERING CODE

MODEL

DDMX-RGBW

DDMX-RGBW - DMX decoder

Translates controller DMX512 programs for RGB and white LED strips.

Unique DMX address for the decoder can be set easily and displayed by the numeric display on the case. Changing and resetting the DMX address requires manual input.

Use power repeater to expand output.

Operating Voltage

12-36 VDC

Power Capacity

up to 96W at 24V

Operating Temperature Range

from -4°F to +122°F in case

Smart Pixel Decoder

SPI signal to DMX signal decoder



ORDERING CODE

MODEL

SR-DMX-SPI

SR-DMX-SPI - Smart Pixel Decoder

The SR-DMX-SPI is a smart LED pixel decoder that controls RGB/RGBW pixel LED strips with SPI signal. Designed with an OLED backlit panel, the pixel controller allows for easy configuration of most settings. Four push buttons are available for control of the LED functions.

* For pixel only.

Features

- 2 in 1 in-Wall Controller: DMX Control or Wireless RGB-W
- SPI signal output for RGB/RGBW pixel light control
- DMX512 controllable and RF/WIFI remote controllable
- Capable of addressing up to 1020 RGB pixels & 765 RGBW pixels
- OLED panel allows for easy configuration

Operating Voltage

12 - 36V DC

Power capacity

up to 96W at 24V

Operating temperature range

from -4°F to +122°F in case