

0-10V Warm Dim 96 Watt LED Driver - Installation Instructions

Models PS010VD-96-24-W2X

Please read all instructions prior to installation and keep for future reference!

THIS LED DRIVER IS TO BE INSTALLED IN ACCORDANCE WITH ARTICLE 450 OF THE NATIONAL ELECTRICAL CODE. THE LED DRIVER MUST BE INSTALLED IN A WELL VENTILATED AREA AND FREE FROM EXPLOSIVE GASES AND VAPORS. PROPER OPERATION REQUIRES THE FREE FLOW OF AIR. AS THIS LED DRIVER IS HARDWIRED, IT SHOULD ONLY BE INSTALLED BY A QUALIFIED ELECTRICIAN. SUITABLE FOR DAMP LOCATION.



7777 Merrimac Ave
Niles, IL 60714
T 224.333.6033
F 224.757.7557
info@luminii.com
www.luminii.com

REVO.6
07132023

1 / 5

Input	120 - 277 V AC, 1.1 A, 50/60 Hz
Output	24 V DC, 4.0 A
Max. Wattage	96 W

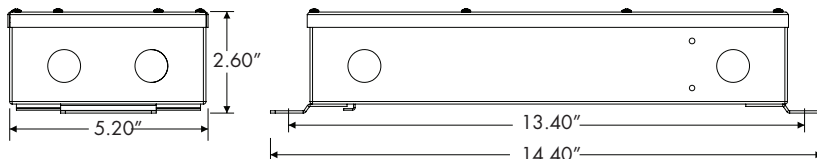

1 Before installing, check the label and ensure the LED Driver has the proper input voltage, output voltage, and wattage for the job. Check the wire markings to ensure they match the wiring diagram below. Refer to table above for the maximum loads!

1.1 LED Driver can be mounted vertically or horizontally. With a minimum of 3" clearance around LED Driver to provide proper air circulation.

2

2.1 Remove the cover from top of the driver housing to expose the driver wires. Screws for cover will be found inside the housing.

3

3.1 Connect the 120-277V AC power into the housing from the electrical panel, followed by connecting the 24V DC low voltage conduit; one for the LED and one for the controller wires. Refer to the diagram to make all the proper wiring connections.

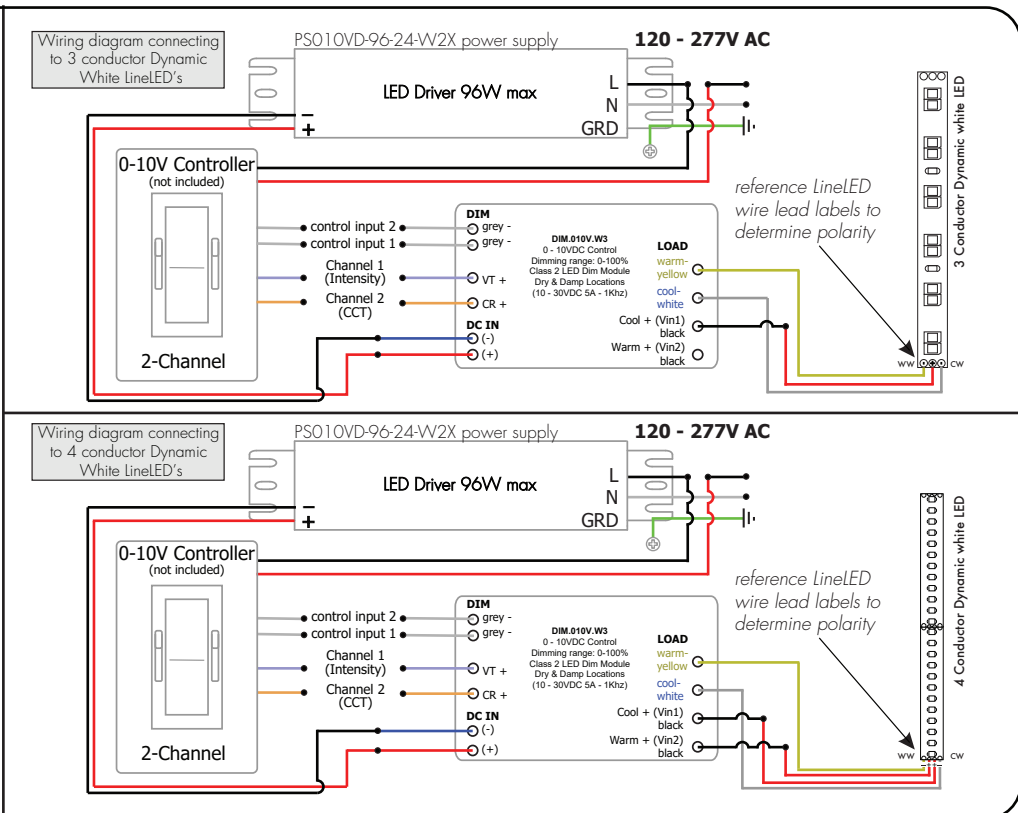

0-10V Warm Dim 96 Watt LED Driver - Installation Instructions

Models PS010VD-96-24-W2X

Please read all instructions prior to installation and keep for future reference!

THIS LED DRIVER IS TO BE INSTALLED IN ACCORDANCE WITH ARTICLE 450 OF THE NATIONAL ELECTRICAL CODE. THE LED DRIVER MUST BE INSTALLED IN A WELL VENTILATED AREA AND FREE FROM EXPLOSIVE GASES AND VAPORS. PROPER OPERATION REQUIRES THE FREE FLOW OF AIR. AS THIS LED DRIVER IS HARDWIRED, IT SHOULD ONLY BE INSTALLED BY A QUALIFIED ELECTRICIAN. SUITABLE FOR DAMP LOCATION.



REVO.6
07132023

2 / 5



7777 Merrimac Ave
Niles, IL 60714
T 224.333.6033
F 224.757.7557
info@luminii.com
www.luminii.com

4

4.1 Insert the wire nut connections in the driver housing. Close housing cover and secure using the eight screws.

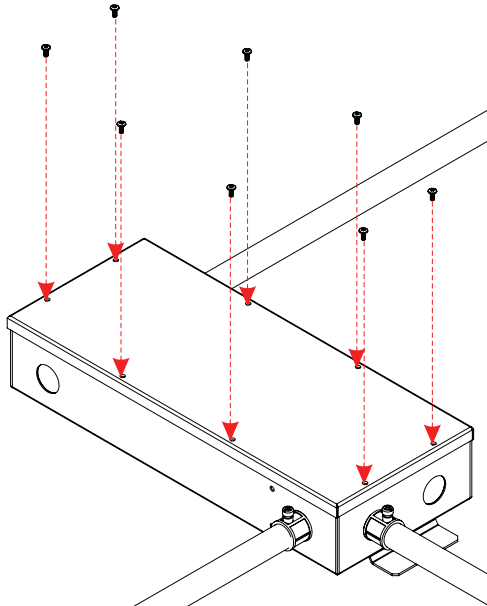

0-10V Warm Dim 96 Watt LED Driver - Installation Instructions

Models PS010VD-96-24-W2X

Please read all instructions prior to installation and keep for future reference!

THIS LED DRIVER IS TO BE INSTALLED IN ACCORDANCE WITH ARTICLE 450 OF THE NATIONAL ELECTRICAL CODE. THE LED DRIVER MUST BE INSTALLED IN A WELL VENTILATED AREA AND FREE FROM EXPLOSIVE GASES AND VAPORS. PROPER OPERATION REQUIRES THE FREE FLOW OF AIR. AS THIS LED DRIVER IS HARDWIRED, IT SHOULD ONLY BE INSTALLED BY A QUALIFIED ELECTRICIAN. SUITABLE FOR DAMP LOCATION.



REVO.6
07132023

3 / 5



7777 Merrimac Ave
Niles, IL 60714
T 224.333.6033
F 224.757.7557
info@luminii.com
www.luminii.com

User Guide Instructions

1

1.1 Download VintageDim® App from [Google Play Store](#) for Android OS or [Apple App Store](#) for iOS.

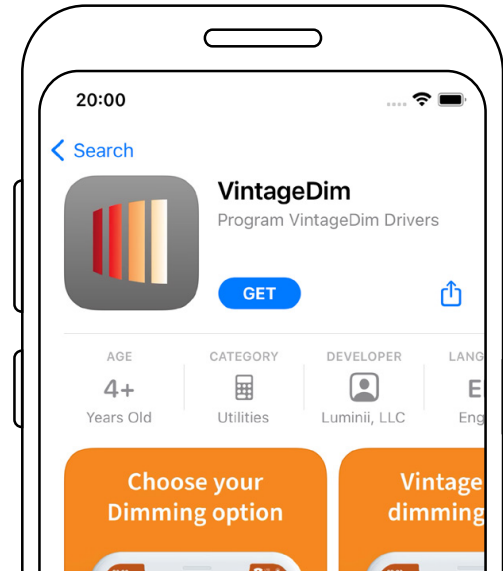
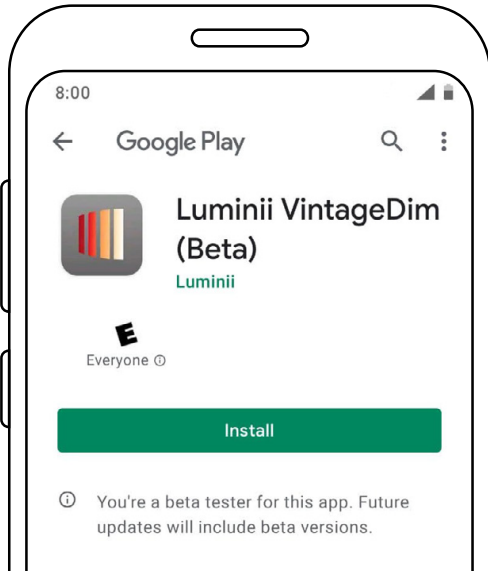

2

2.1 Open the App and choose one of the factory pre-build presets.

1. VintageDim® Warm Dim (page 2)
2. Two Channel: Intensity and CCT (page 3)
3. Two Channel: Individual Control (page 4)

For a custom Curve option follow the steps on page 5.

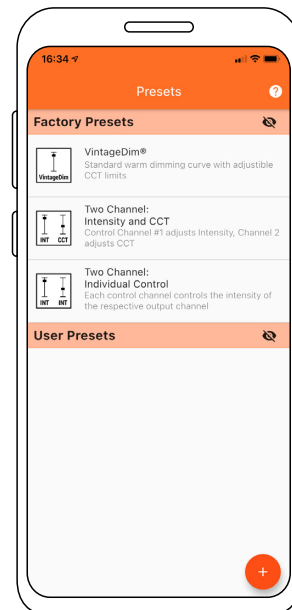

0-10V Warm Dim 96 Watt LED Driver - Installation Instructions

Models PS010VD-96-24-W2X



7777 Merrimac Ave
Niles, IL 60714
T 224.333.6033
F 224.757.7557
info@luminii.com
www.luminii.com

REV.0.6
07132023

4 / 5

Please read all instructions prior to installation and keep for future reference!

THIS LED DRIVER IS TO BE INSTALLED IN ACCORDANCE WITH ARTICLE 450 OF THE NATIONAL ELECTRICAL CODE. THE LED DRIVER MUST BE INSTALLED IN A WELL VENTILATED AREA AND FREE FROM EXPLOSIVE GASES AND VAPORS. PROPER OPERATION REQUIRES THE FREE FLOW OF AIR. AS THIS LED DRIVER IS HARDWIRED, IT SHOULD ONLY BE INSTALLED BY A QUALIFIED ELECTRICIAN. SUITABLE FOR DAMP LOCATION.

Using the App

3



3.1 Select "Create New Preset" button.

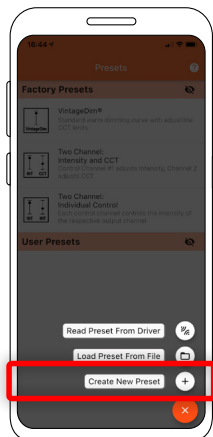

3.2 Change the preset name and description to your own.

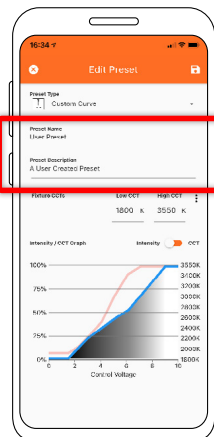

3.3 Set the CCT values of your light source or choose from preset Fixture CCTs option

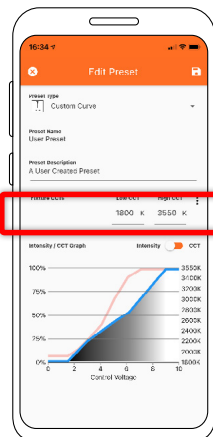

3.4 Tap into the dim curve editing window.

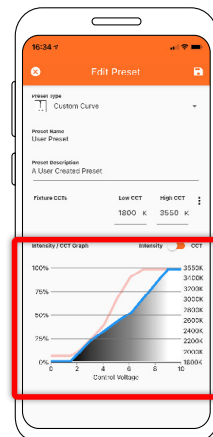

3.5 Select the dots on the intensity curve blue line and drag them into the desired position. The X Axis is control voltage and the Y Axis is intensity. Repeat for each plot point on the line until the desired curve is achieved.

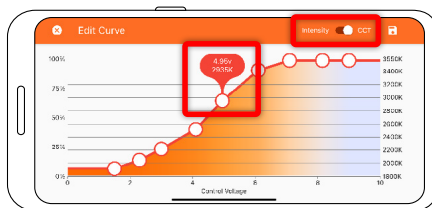

Use the toggle in the upper right corner to switch to the CCT curve. Drag each plot point on the red line to the desired positions. This time the Y axis indicates CCT.



Once the desired curves are set, tap the Save button in the upper right corner again to save the preset.



3.6 Select your new user preset from the main list.

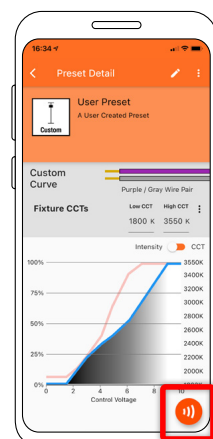

3.7 Press Program button.

3.8 Place phone directly on the VintageDim® module. Phone will play a tone when programming begins. Programming is complete when you hear a single beep and see the "Programming Successful" screen.

If the driver was off during programming, simply power on and the driver will work according to the new program. If the driver was on during programming, it will need to be power cycled for new programming to become active.

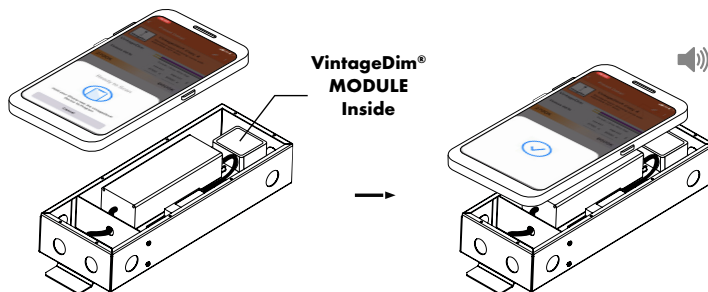

* Lid of driver case must be removed.

0-10V Warm Dim 96 Watt LED Driver - Installation Instructions

Models PS010VD-96-24-W2X

Please read all instructions prior to installation and keep for future reference!

THIS LED DRIVER IS TO BE INSTALLED IN ACCORDANCE WITH ARTICLE 450 OF THE NATIONAL ELECTRICAL CODE. THE LED DRIVER MUST BE INSTALLED IN A WELL VENTILATED AREA AND FREE FROM EXPLOSIVE GASES AND VAPORS. PROPER OPERATION REQUIRES THE FREE FLOW OF AIR. AS THIS LED DRIVER IS HARDWIRED, IT SHOULD ONLY BE INSTALLED BY A QUALIFIED ELECTRICIAN. SUITABLE FOR DAMP LOCATION.



REVO.6
07132023



7777 Merrimac Ave
Niles, IL 60714
T 224.333.6033
F 224.757.7557
info@luminii.com
www.luminii.com

5 / 5

Using the App

4

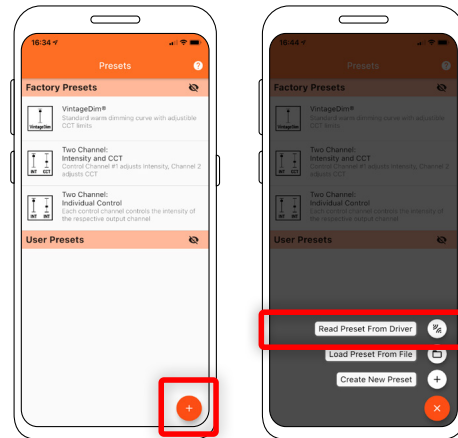

4.1 Select Read Preset From Driver button.

4.2 Place phone directly on the VintageDim® module. Reading is complete when you see the following confirmation on screen.

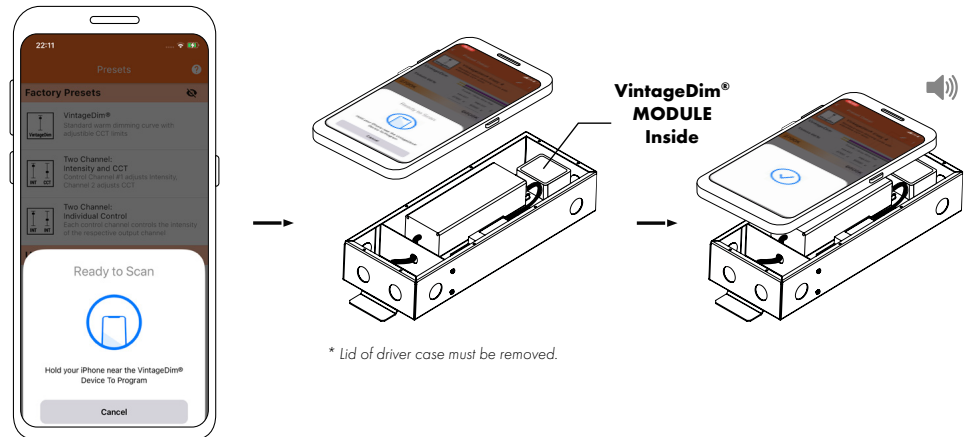

3.3 After successful reading you will see new user preset created with corresponding name and description.

