

**Features**

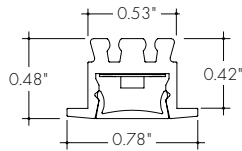
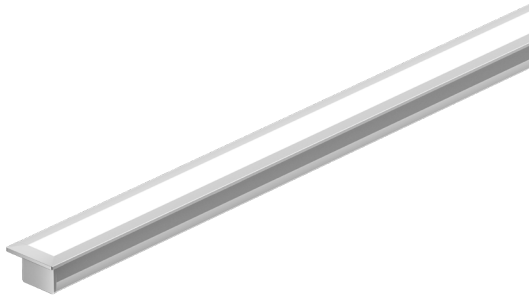

- 24VDC Class 2 fixtures made to order up to 144". Fixtures can be linked up to 48' depending on output
- Suitable for millwork, recessed, architectural reveals, and accent lighting applications
- Approved for closet/storage space installation per NEC 410.16(A)(3) and 410.16(C)(5)\*
- Dot free even illumination with frosted lens and high color outputs
- Class 2 listed for damp locations
- High Color Quality options offer premium quality and vibrant colors with R9 values up to 97
- High Efficacy options offer best in class output and efficacy with over 570 lm/ft and up to 103 lm/W
- Proprietary strong bond solder method handles up to 50 lbs of pull force on wire leads and connectors
- 7 Year warranty

**Finish Options** (see page 2 for additional information)

- Base  Silver Anodized
- Standard  Black  Bronze  White
- Premium  Matte Black  Warm Nickel  Aged Brass  Polished Gold  Chrome



**Technical Information**

TYPE	High Color Quality			High Efficacy			
	72SO	72HO	72VHO	HE48LO	HE48SO	HE48MO	HE48HO
<b>OUTPUT OPTIONS</b>							
<b>Lumens Output (3000K)</b> <small>(with a Clear Lens)</small>	201 lm/ft	326 lm/ft	396 lm/ft	195 lm/ft	271 lm/ft	361 lm/ft	579 lm/ft
<b>Average Power Consumption</b> <small>(for a 4" section)</small>	2.8 W/ft	4.8 W/ft	6 W/ft	1.9 W/ft	2.8 W/ft	3.5 W/ft	6.5 W/ft
<b>Efficacy</b>	72 lm/W	68 lm/W	66 lm/W	103 lm/W	97 lm/W	103 lm/W	89 lm/W
<b>Max Run Length</b> <small>(in series)</small>	40 ft	31 ft	22 ft	48 ft	42 ft	33 ft	21 ft
<b>Max Ambient Temperature*</b>	50°C [122°F]		45°C [113°F]	50°C [122°F]		40°C [104°F]	

\*Max Ambient Temperature to maintain L70 of 50k+ hours. Exceeding Max Ambient Temperature may result in decreased life/output. Consult Technical Support for specific inquiries.

**High Color Quality (72)**

CCT	Multiplier <small>(reference - 3000K)</small>	CRI	TM-30		
			R <sub>f</sub>	R <sub>g</sub>	R <sub>9</sub>
1900K	0.55	96	94	97	90
2200K	0.70	96	95	101	89
2400K	0.72	98	97	101	91
2700K	0.74	97	96	101	91
3000K	1.00	97	95	104	97
3500K	1.02	97	94	105	97
4100K	1.07	97	90	99	97

**High Efficacy (HE48/HE64)**

CCT	Multiplier <small>(reference - 3000K)</small>	CRI	TM-30		
			R <sub>f</sub>	R <sub>g</sub>	R <sub>9</sub>
2200K	0.73	92	91	97	42
2500K	0.81	93	96	96	62
2700K	0.94	92	90	99	58
3000K	1.00	92	89	99	57
3500K	1.02	92	89	99	60
4000K	1.02	92	86	94	71

**Ordering Code**

MODEL	LENGTH <sup>1</sup>	OUTPUT	CCT	LENS <sup>2</sup>	MOUNTING	FINISH <sup>3</sup>	POSITION TYPE	POWER FEED
MKR - Myka Recessed Trimmed	12"-144" 1" increments	72SO - Standard 72HO - High 72VHO - Very High	19K - 1900K 22K - 2200K 24K - 2400K 27K - 2700K 30K - 3000K 35K - 3500K 41K - 4100K	C - Clear HF - Half Frosted F - Frosted MF - Matte Frosted BLV - Black Blade Louver WLV - White Blade Louver	HS - Hard Surface Mounting Bracket GS - Gypsum Surface Mounting Bracket NB - No Bracket	<b>Base</b> SA - Silver Anodized  <b>Standard</b> BK - Black BZ - Bronze WH - White  <b>Premium</b> MBK - Matte Black WN - Warm Nickel AB - Aged Brass PG - Polished Gold <sup>4</sup> CH - Chrome <sup>4</sup>	B - Back E - End	P1 - Plenum 72" wire leads P1X2 - Plenum 72" wire leads at both ends 2 - 72" wire leads at one end and Quick Connect at other 3 - Single Quick Connect 4 - Dual Quick Connect
	12"-144" 2" increments	HE48LO - Low HE48SO - Standard HE48MO - Medium HE48HO - High	22K - 2200K 25K - 2500K 27K - 2700K 30K - 3000K 35K - 3500K 40K - 4000K					

1 - Custom lengths and increments are available, please consult Inside Sales with specific request.  
 2 - All High Efficacy options can be used to comply with Title 24 JAB. High Color Quality options can be used to comply with Title 24 JAB depending on Output, CCT, and lens selections. See multiplier charts to calculate specific efficacies.  
 3 - Non SA finishes may have extended lead times and price adders. Custom RALs are available, contact Inside Sales with specific request.  
 4 - Polished Gold, and Chrome finishes have a maximum fixture length of 96".  
 5 - Closet/Storage Space ratings only available on fixtures with outputs 5.7W/ft or less

**Product Dimensions**

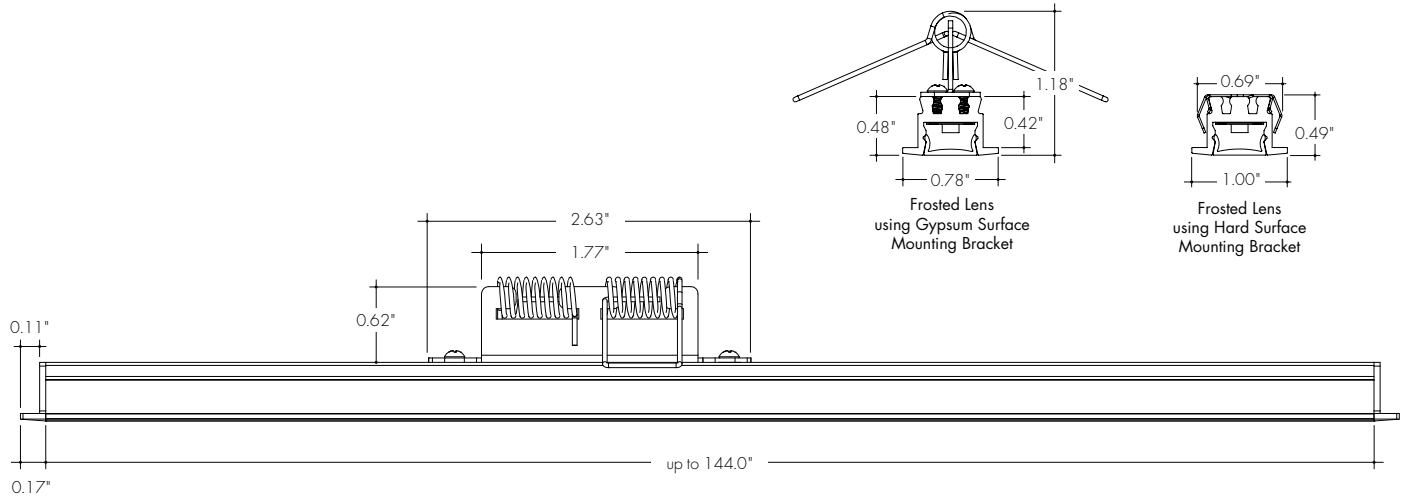

**Finish Options**

- Finish options are available in a wide variety, allowing for complete customization of style and aesthetic.
- Non Silver Anodized finishes may have extended lead times and price adder.
- Polished Gold and Chrome finishes have a maximum fixture length of 96".
- Custom RALs are available, please consult Inside Sales with specific request.

**Silver Anodized Base**

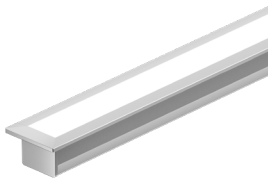

Silver Anodized is a soft silver with a clear finish.

**Black Standard**

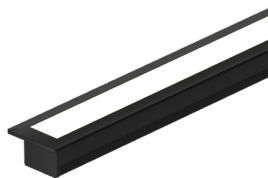

Black is a true deep black with a glossy finish.

**Bronze Standard**

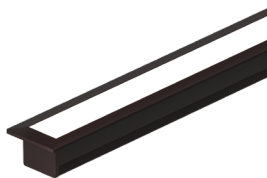

Bronze is a rich, dark brown with a satin finish.

**White Standard**



White is a polar bright white and field paintable.

**Matte Black Premium**



Matte Black is a dark, pitch-black with a soft flat finish.

**Warm Nickel Premium**



Warm Nickel is a soft, silvery smoke with warm tones and a satin finish.

**Aged Brass Premium**

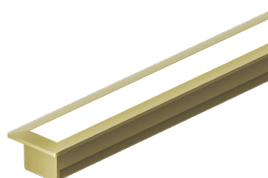

Aged Brass is a deep brown shade with slightly golden undertones.

**Polished Gold Premium**

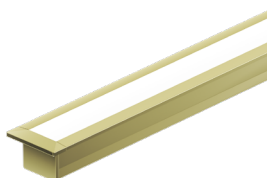

Polished Gold is bright and radiant for a brilliant finish.

**Chrome Premium**



Chrome is a highly reflective silver polish.

**Powerfeeds and Connectors**

**Linking and Extension Cable Options**

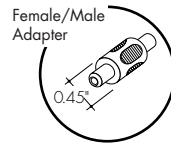
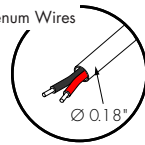
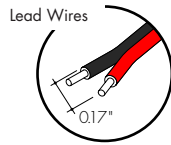
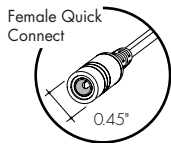
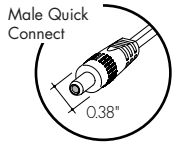

**LMC-12**  
Male quick-connect, 2 pin, 12"

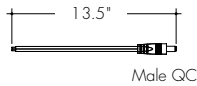

**LMC-70**  
Male quick-connect long, 2 pin, 70"

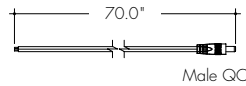

**EC-12**  
Female to Female Extension Cable, 2 pin, 12"

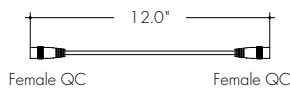

**EC-48**  
Female to Female Extension Cable, 2 pin, 48"

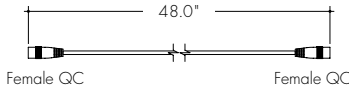

**EC-120**  
Female to Female Extension Cable, 2 pin, 120"

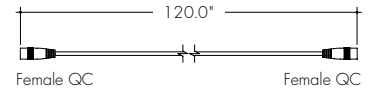

**LYC**  
1 Female to 2 Male Splitter Cable, 2 pin, 12"

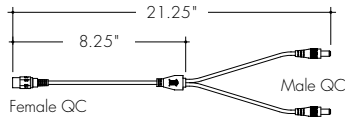

**FMA**  
Female to male adapter

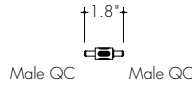

**IS-DC**  
Male to Female Inline DC Switch, 2 pin, 12"

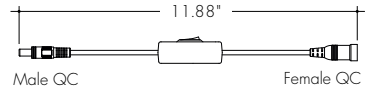

**Powerfeeds Position/Type**

Back feeds shown as dashed lines  
All wires are 18 AWG unless otherwise specified

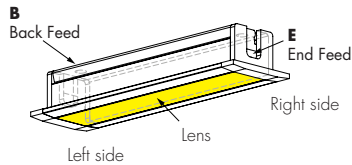

**P1**  
72" plenum wire leads

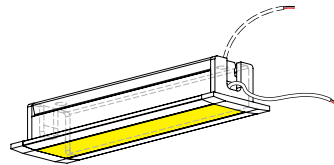

**P1X2**  
72" plenum wire leads at both end

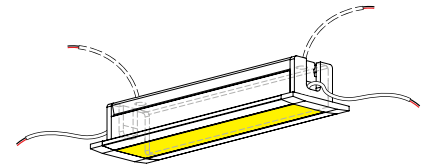

**2**  
72" rip cord at one end and Female Quick Connect at other

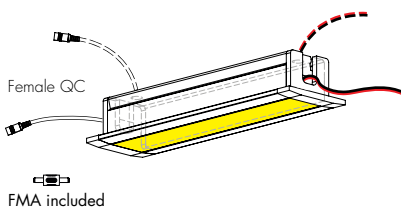

**3**  
Single Female Quick Connect

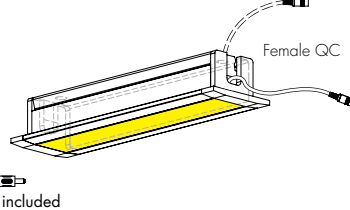

**4**  
Dual Female Quick Connect

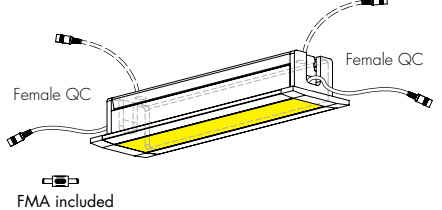

**Sample Layout**

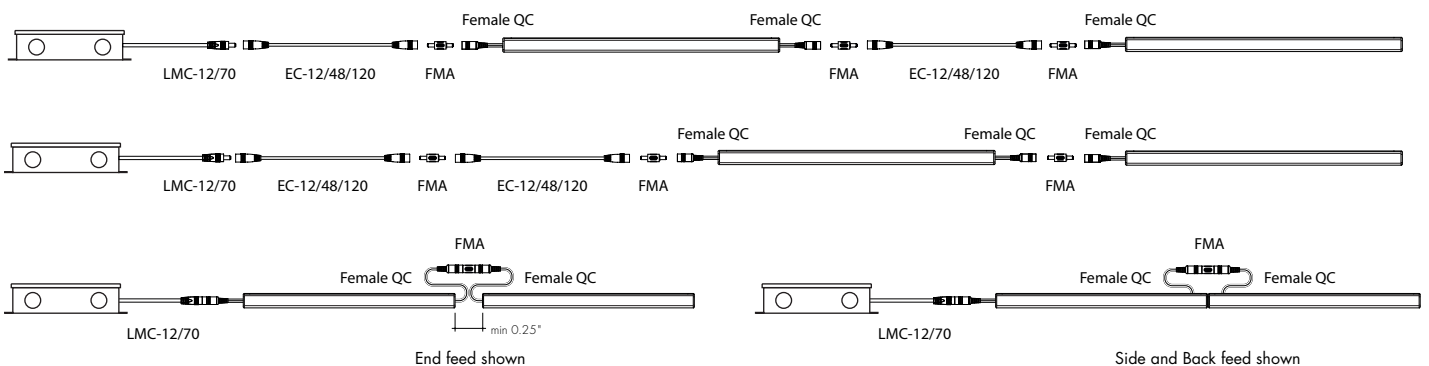

Light Transmission and Dotting

Output Options	Lens/Accessory					
	Clear Lens	Half-Frosted Lens	Matte Frosted Lens	Frosted Lens	White Blade Louver	Black Blade Louver
72SO	CD	SD	ND	ND	ND	ND
72HO	CD	SD	ND	ND	ND	ND
72VHO	CD	SD	ND	ND	ND	ND
HE48LO	CD	CD	SD	SD	SD	SD
HE48SO	CD	CD	SD	SD	SD	SD
HE48MO	CD	CD	SD	SD	SD	SD
HE48HO	CD	CD	SD	SD	SD	SD
Transmission Percentage	100%	84%	79%	62%	50%	34%

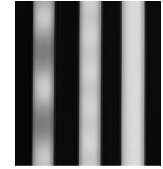

CD SD ND  
 CD - Clear Dotting  
 SD - Slight Dotting  
 ND - No Dotting

Accessory Options

**LVSP-4T-BK**  
 Low Voltage, 4 Terminal Splice Box, Black

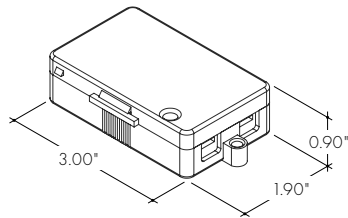

**OS-DC-F4-BK**  
 Occupancy Sensor

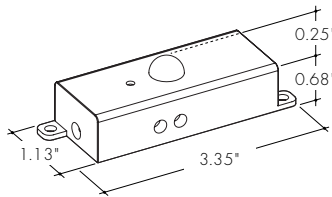

Male Quick Connect, FMA, ILC, LYC, or IS-DC are required for input and output.

**DIM-DC-F4-BK**  
 24VDC Low Voltage In-line Dimmer Module

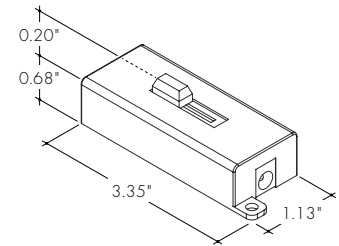

Male Quick Connect, FMA, ILC, LYC, or IS-DC are required for input and output.

**LV-BL-MKC-12-BK**  
 Blade Louver reduces glare at high angle in two directions  
 Also available with complete fixture, use ordering code **-BLV**

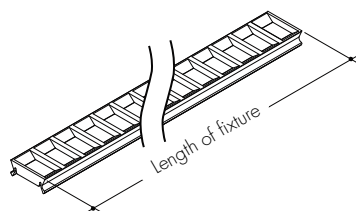

This Black louver/lens combo comes in 12" increments and sits in place of a Myka lens, not in addition to.

**LV-BL-MKC-12-WH**  
 Blade Louver reduces glare at high angle in two directions  
 Also available with complete fixture, use ordering code **-BLV**

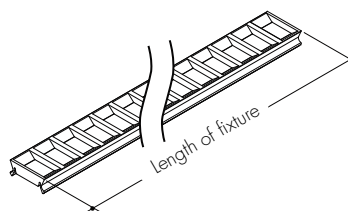

This White louver/lens combo comes in 12" increments and sits in place of a Myka lens, not in addition to.

Photometry

MKR-48-30K-72VHO-C

Myka Recessed Trimmed, 4ft, 3000K, 72VHO, Clear Lens

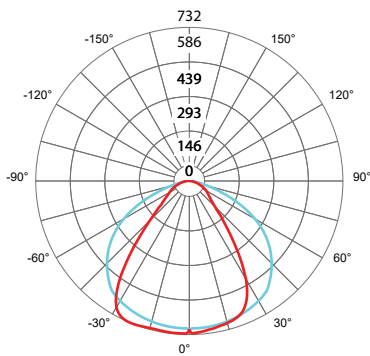

Zonal Lumen Summary 3000K

Zone	Lumen	% Fixture
0-30	551	34.7%
0-40	897	56.6%
0-60	1381	87.2%
0-90	1568	98.9%
0-180	1584	100%

Total

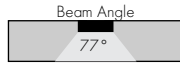

MKR-48-30K-72VHO-HF

Myka Recessed Trimmed, 4ft, 3000K, 72VHO, Half-Frosted Lens

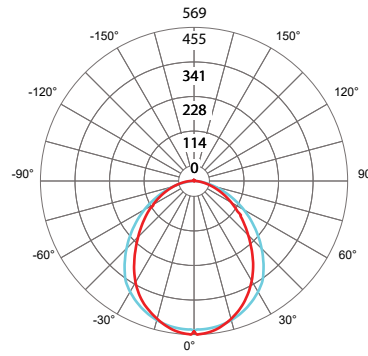

Zonal Lumen Summary 3000K

Zone	Lumen	% Fixture
0-30	397	29.9%
0-40	639	48.1%
0-60	1073	80.7%
0-90	1315	98.9%
0-180	1329	100%

Total

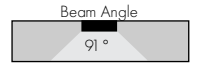

MKR-48-30K-72VHO-F

Myka Recessed Trimmed, 4ft, 3000K, 72VHO, Frosted Lens

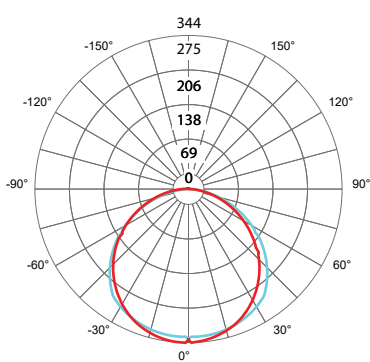

Zonal Lumen Summary 3000K

Zone	Lumen	% Fixture
0-30	252	25.6%
0-40	420	42.5%
0-60	757	76.6%
0-90	976	98.8%
0-180	988	100%

Total

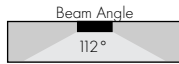

MKR-48-30K-72VHO-MF

Myka Recessed Trimmed, 4ft, 3000K, 72VHO, Matte-Frosted Lens

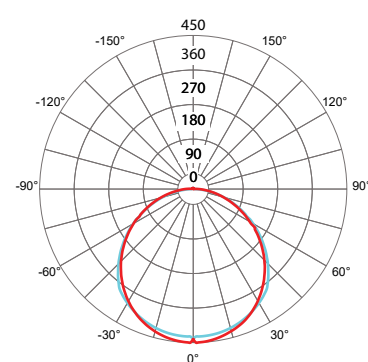

Zonal Lumen Summary 3000K

Zone	Lumen	% Fixture
0-30	322	25.6%
0-40	532	42.5%
0-60	953	76.6%
0-90	1239	98.8%
0-180	1254	100%

Total

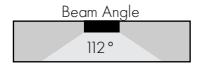

MKR-48-30K-72VHO-BLV

Myka Recessed Trimmed, 4ft, 3000K, 72VHO, Black Blade Louver

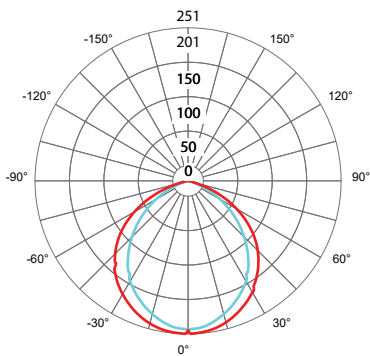

Zonal Lumen Summary 3000K

Zone	Lumen	% Fixture
0-30	175	32.5%
0-40	282	52.3%
0-60	472	87.7%
0-90	533	98.9%
0-180	538	100%

Total

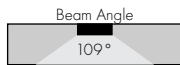

MKR-48-30K-72VHO-WLV

Myka Recessed Trimmed, 4ft, 3000K, 72VHO, White Blade Louver

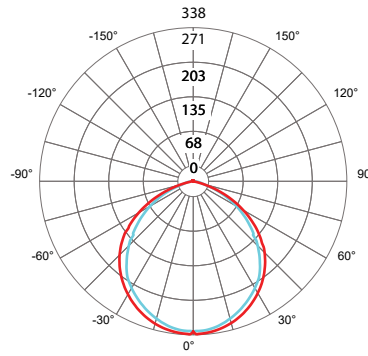

Zonal Lumen Summary 3000K

Zone	Lumen	% Fixture
0-30	240	30.1%
0-40	391	49.1%
0-60	671	84.3%
0-90	787	98.9%
0-180	796	100%

Total

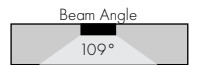

**Power Consumption**

Tested at Full Power with PDC Series power supplies.

Standard Nominal Lengths offered provide minimal shadowing. For alternate lengths, please consult Inside Sales with specific request.

**High Color Quality (72)**

Nominal Length (in)	Actual Length	Watts			Nominal Length (in)	Actual Length	Watts			Nominal Length (in)	Actual Length	Watts			Nominal Length (in)	Actual Length	Watts		
		SO	HO	VHO			SO	HO	VHO			SO	HO	VHO			SO	HO	VHO
12	11 5/16	2.7	4.4	6.2	47	46	10.2	17.1	22.6	82	81 15/16	18.3	29.5	38.4	117	116 11/16	25.9	40.8	52.4
13	12 7/16	2.7	4.4	6.2	48	47 3/16	10.5	17.4	23.1	83	-	-	-	-	118	117 13/16	26.1	41.1	52.8
14	13 10/16	2.9	4.8	6.7	49	48 6/16	10.7	17.8	23.5	84	83 1/16	18.5	29.8	38.8	119	119	26.3	41.4	53.2
15	14 12/16	3.1	5.2	7.3	50	49 8/16	11.1	18.6	24.4	85	84 4/16	18.7	30.1	39.2	120	-	-	-	-
16	15 15/16	3.4	5.6	7.8	51	50 11/16	11.4	18.9	24.9	86	85 6/16	19.2	30.8	40.0	121	120 2/16	26.5	41.7	53.6
17	-	-	-	-	52	51 13/16	11.6	19.3	25.3	87	86 9/16	19.4	31.1	40.4	122	121 5/16	26.7	42.0	54.0
18	17 1/16	3.6	6.0	8.3	53	53	11.9	19.7	25.7	88	87 11/16	19.6	31.5	40.8	123	122 7/16	27.1	42.6	54.7
19	18 4/16	3.9	6.5	8.9	54	-	-	-	-	89	88 14/16	19.9	31.8	41.1	124	123 10/16	27.3	42.9	55.0
20	19 6/16	4.4	7.3	9.9	55	54 2/16	12.1	20.1	26.1	90	-	-	-	-	125	124 12/16	27.5	43.1	55.4
21	20 9/16	4.6	7.7	10.5	56	55 5/16	12.3	20.5	26.6	91	90 1/16	20.1	32.2	41.5	126	125 15/16	27.7	43.4	55.7
22	21 11/16	4.8	8.1	11.0	57	56 7/16	12.8	21.3	27.4	92	91 3/16	20.4	32.5	41.9	127	-	-	-	-
23	22 14/16	5.1	8.6	11.5	58	57 10/16	13.1	21.6	27.8	93	92 6/16	20.6	32.9	42.3	128	127 1/16	27.9	43.7	56.1
24	-	-	-	-	59	58 12/16	13.3	22.0	28.3	94	93 8/16	21.1	33.6	43.1	129	128 4/16	28.1	43.9	56.4
25	24	5.3	9.0	12.1	60	59 15/16	13.6	22.4	28.7	95	94 11/16	21.3	33.9	43.4	130	129 6/16	28.5	44.5	57.1
26	25 3/16	5.6	9.4	12.6	61	-	-	-	-	96	95 13/16	21.5	34.2	43.8	131	130 9/16	28.7	44.7	57.4
27	26 6/16	5.8	9.8	13.1	62	61 1/16	13.8	22.8	29.1	97	97	21.8	34.6	44.2	132	131 11/16	28.9	45.0	57.8
28	27 8/16	6.2	10.5	14.1	63	62 4/16	14.0	23.1	29.6	98	-	-	-	-	133	132 14/16	29.1	45.3	58.1
29	28 11/16	6.5	10.9	14.5	64	63 6/16	14.5	23.8	30.5	99	98 2/16	22.0	34.9	44.6	134	-	-	-	-
30	29 13/16	6.7	11.2	15.0	65	64 9/16	14.7	24.1	31.0	100	99 5/16	22.2	35.2	45.0	135	134 1/16	29.3	45.5	58.4
31	31	6.9	11.6	15.5	66	65 11/16	14.9	24.4	31.4	101	100 7/16	22.5	35.9	45.9	136	135 3/16	29.5	45.7	58.7
32	-	-	-	-	67	66 14/16	15.1	24.7	31.9	102	101 10/16	22.7	36.2	46.3	137	136 6/16	29.6	45.9	59.1
33	32 2/16	7.1	12.0	16.0	68	-	-	-	-	103	102 12/16	22.9	36.5	46.7	138	137 8/16	30.0	46.3	59.7
34	33 5/16	7.3	12.3	16.5	69	68	15.3	25.0	32.4	104	103 15/16	23.1	36.8	47.1	139	138 11/16	30.2	46.5	60.0
35	34 7/16	7.8	13.1	17.4	70	69 3/16	15.5	25.4	32.8	105	-	-	-	-	140	139 13/16	30.3	46.8	60.3
36	35 10/16	8.0	13.4	17.9	71	70 6/16	15.8	25.7	33.3	106	105 1/16	23.3	37.1	47.5	141	141	30.5	47.0	60.6
37	36 12/16	8.2	13.8	18.4	72	71 8/16	16.2	26.3	34.2	107	106 4/16	23.5	37.4	48.0	142	-	-	-	-
38	37 15/16	8.4	14.2	18.9	73	72 11/16	16.4	26.6	34.7	108	107 6/16	23.9	38.1	48.8	143	142 2/16	30.7	47.2	61.0
39	-	-	-	-	74	73 13/16	16.6	26.9	35.1	109	108 9/16	24.1	38.4	49.2	144	143 5/16	30.8	47.4	61.3
40	39 1/16	8.7	14.5	19.3	75	75	16.8	27.3	35.5	110	109 11/16	24.3	38.7	49.6					
41	40 4/16	8.9	14.9	19.8	76	-	-	-	-	111	110 14/16	24.5	39.0	50.0					
42	41 6/16	9.3	15.6	20.7	77	76 2/16	17.1	27.6	35.9	112	-	-	-	-					
43	42 9/16	9.6	16.0	21.2	78	77 5/16	17.3	27.9	36.3	113	112 1/16	24.8	39.3	50.4					
44	43 11/16	9.8	16.4	21.7	79	78 7/16	17.7	28.5	37.2	114	113 3/16	25.0	39.6	50.8					
45	44 14/16	10.0	16.7	22.1	80	79 10/16	17.9	28.9	37.6	115	114 6/16	25.2	39.9	51.2					
46	-	-	-	-	81	80 12/16	18.1	29.2	38.0	116	115 8/16	25.6	40.5	52.0					

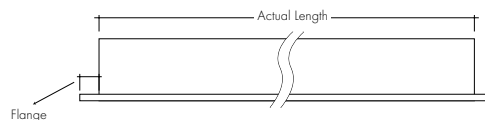

**Power Consumption**

Tested at Full Power with PDC Series power supplies.

Standard Nominal Lengths offered provide minimal shadowing. For alternate lengths, please consult Inside Sales with specific request.

**High Efficacy (HE48)**

Nominal Length (in)	Actual Length	Watts				Nominal Length (in)	Actual Length	Watts				Nominal Length (in)	Actual Length	Watts				Nominal Length (in)	Actual Length	Watts			
		LO	SO	MO	HO			LO	SO	MO	HO			LO	SO	MO	HO			LO	SO	MO	HO
12	10 10/16	1.7	2.5	3.5	5.7	47	46 10/16	6.9	10.7	13.3	24.7	82	-	-	-	-	117	116 10/16	17.3	27.3	33.7	57.9	
13	12 10/16	1.7	2.5	3.5	5.7	48	-	-	-	-	-	83	82 10/16	12.5	19.9	23.9	42.2	118	-	-	-	-	
14	-	-	-	-	-	49	48 10/16	7.1	11.2	13.9	25.4	84	-	-	-	-	119	118 10/16	17.5	27.7	34.3	58.7	
15	14 10/16	2.0	3.0	4.0	7.2	50	-	-	-	-	-	85	84 10/16	12.8	20.3	24.5	43.1	120	-	-	-	-	
16	-	-	-	-	-	51	50 10/16	7.4	11.7	14.5	26.3	86	-	-	-	-	121	120 10/16	17.8	28.1	34.9	59.6	
17	16 10/16	2.4	3.5	4.6	8.7	52	-	-	-	-	-	87	86 10/16	13.1	20.8	25.1	44.1	122	-	-	-	-	
18	-	-	-	-	-	53	52 10/16	7.7	12.3	15.1	27.4	88	-	-	-	-	123	122 10/16	18.1	28.6	35.5	60.5	
19	18 10/16	2.7	3.9	5.2	10.2	54	-	-	-	-	-	89	88 10/16	13.4	21.3	25.7	45.0	124	-	-	-	-	
20	-	-	-	-	-	55	54 10/16	8.0	12.9	15.7	28.5	90	-	-	-	-	125	124 10/16	18.3	29.0	36.0	62.1	
21	20 10/16	3.0	4.4	5.8	11.7	56	-	-	-	-	-	91	90 10/16	13.7	21.7	26.3	46.0	126	-	-	-	-	
22	-	-	-	-	-	57	56 10/16	8.4	13.5	16.4	29.5	92	-	-	-	-	127	126 10/16	18.4	29.5	36.6	63.8	
23	22 10/16	3.4	4.9	6.4	13.2	58	-	-	-	-	-	93	92 10/16	14.0	22.1	26.9	47.0	128	-	-	-	-	
24	-	-	-	-	-	59	58 10/16	8.7	14.0	17.0	30.6	94	-	-	-	-	129	128 10/16	18.6	29.9	37.2	65.4	
25	24 10/16	3.7	5.4	7.0	14.7	60	-	-	-	-	-	95	94 10/16	14.3	22.6	27.5	47.9	130	-	-	-	-	
26	-	-	-	-	-	61	60 10/16	9.0	14.6	17.6	31.6	96	-	-	-	-	131	130 10/16	18.8	30.4	37.7	67.0	
27	26 10/16	4.1	5.9	7.5	15.8	62	-	-	-	-	-	97	96 10/16	14.4	22.8	27.8	48.4	132	-	-	-	-	
28	-	-	-	-	-	63	62 10/16	9.4	15.2	18.2	32.6	98	-	-	-	-	133	132 10/16	18.9	30.8	38.3	68.6	
29	28 10/16	4.4	6.4	8.1	16.8	64	-	-	-	-	-	99	98 10/16	14.7	23.3	28.5	49.4	134	-	-	-	-	
30	-	-	-	-	-	65	64 10/16	9.7	15.6	18.7	33.7	100	-	-	-	-	135	134 10/16	19.1	31.2	38.9	70.2	
31	30 10/16	4.8	6.9	8.7	17.9	66	-	-	-	-	-	101	100 10/16	15.0	23.7	29.0	50.4	136	-	-	-	-	
32	-	-	-	-	-	67	66 10/16	10.0	16.1	19.2	34.7	102	-	-	-	-	137	136 10/16	19.3	31.8	39.4	70.7	
33	32 10/16	5.0	7.2	9.0	18.5	68	-	-	-	-	-	103	102 10/16	15.3	24.1	29.6	51.3	138	-	-	-	-	
34	-	-	-	-	-	69	68 10/16	10.4	16.5	19.8	35.7	104	-	-	-	-	139	138 10/16	19.5	32.3	40.0	71.2	
35	34 10/16	5.4	7.7	9.6	19.5	70	-	-	-	-	-	105	104 10/16	15.6	24.6	30.2	52.3	140	-	-	-	-	
36	-	-	-	-	-	71	70 10/16	10.7	17.0	20.3	36.7	106	-	-	-	-	141	140 10/16	19.8	32.8	40.6	71.8	
37	36 10/16	5.7	8.2	10.2	20.6	72	-	-	-	-	-	107	106 10/16	15.8	25.0	30.7	53.2	142	-	-	-	-	
38	-	-	-	-	-	73	72 10/16	11.0	17.4	20.8	37.7	108	-	-	-	-	143	142 10/16	20.0	33.3	41.1	72.3	
39	38 10/16	6.0	8.7	10.8	21.5	74	-	-	-	-	-	109	108 10/16	16.1	25.5	31.3	54.2	144	-	-	-	-	
40	-	-	-	-	-	75	74 10/16	11.3	17.9	21.4	38.7	110	-	-	-	-	-	-	-	-	-	-	
41	40 10/16	6.2	9.2	11.4	22.3	76	-	-	-	-	-	111	110 10/16	16.4	25.9	31.9	55.2	-	-	-	-	-	
42	-	-	-	-	-	77	76 10/16	11.6	18.4	22.0	39.6	112	-	-	-	-	-	-	-	-	-	-	
43	42 10/16	6.4	9.7	12.0	23.1	78	-	-	-	-	-	113	112 10/16	16.7	26.4	32.5	56.1	-	-	-	-	-	
44	-	-	-	-	-	79	78 10/16	11.9	18.9	22.7	40.5	114	-	-	-	-	-	-	-	-	-	-	
45	44 10/16	6.7	10.2	12.6	23.9	80	-	-	-	-	-	115	114 10/16	17.0	26.8	33.1	57.0	-	-	-	-	-	
46	-	-	-	-	-	81	80 10/16	12.2	19.4	23.3	41.4	116	-	-	-	-	-	-	-	-	-	-	

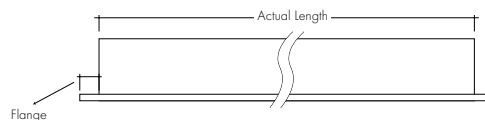

## Voltage Drop Calculator

The below chart assumes nominal voltage of 24 Volts and a Voltage Drop Allowance of 3% through the wire

Wattage [W]	Maximum Wire Length From Power Supply to Start of Run [ft]						
	12 AWG	14 AWG	16 AWG	18 AWG	20 AWG	22 AWG	24 AWG
<b>5</b>	1088.2	684.4	430.3	270.6	170.2	107.1	67.3
<b>10</b>	544.1	342.2	215.1	135.3	85.1	53.5	33.7
<b>15</b>	362.7	228.1	143.4	90.2	56.7	35.7	22.4
<b>20</b>	272.0	171.1	107.6	67.7	42.6	26.8	16.8
<b>25</b>	217.6	136.9	86.1	54.1	34.0	21.4	13.5
<b>30</b>	181.4	114.1	71.7	45.1	28.4	17.8	11.2
<b>35</b>	155.5	97.8	61.5	38.7	24.3	15.3	9.6
<b>40</b>	136.0	85.5	53.8	33.8	21.3	13.4	8.4
<b>45</b>	120.9	76.0	47.8	30.1	18.9	11.9	7.5
<b>50</b>	108.8	68.4	43.0	27.1	17.0	10.7	6.7
<b>55</b>	98.9	62.2	39.1	24.6	15.5	9.7	6.1
<b>60</b>	90.7	57.0	35.9	22.6	14.2	8.9	5.6
<b>65</b>	83.7	52.6	33.1	20.8	13.1	8.2	5.2
<b>70</b>	77.7	48.9	30.7	19.3	12.2	7.6	4.8
<b>75</b>	72.5	45.6	28.7	18.0	11.3	7.1	4.5
<b>80</b>	68.0	42.8	26.9	16.9	10.6	6.7	4.2
<b>85</b>	64.0	40.3	25.3	15.9	10.0	6.3	4.0
<b>90</b>	60.5	38.0	23.9	15.0	9.5	5.9	3.7
<b>96</b>	56.7	35.6	22.4	14.1	8.9	5.6	3.5



**Power Supplies**

See Power Supply instructions and spec sheet for wiring information. For a complete list of compatible dimmers, see Compatible Dimming Chart on the Resources page.

**Universal Power Supply 1% 120VAC - 277VAC**

MODEL	POWER	OUTPUT
PDCU-D - IP20 Dry Series	30 - 30 W 60 - 60 W 96 - 96 W 3X96 - 3X96 W	24 - 24 VDC
PDCU-W - IP66 Wet Series	96 - 96 W 3X96 - 3X96 W	

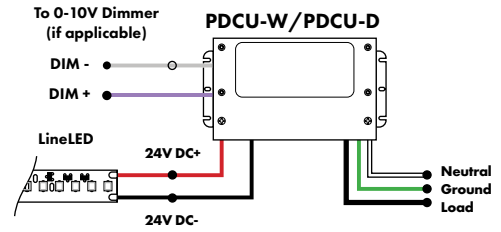

MODELS	PDCU-W 96W	PDCU-W 3X96W	PDCU-D 30W	PDCU-D 60W	PDCU-D 96W	PDCU-D 3X96W
<b>Length</b>	8.66"	11.85"	6.10"	7.93"	8.25"	9.57"
<b>Width</b>	3.73"	4.32"	3.35"	3.35"	4.10"	5.94"
<b>Depth</b>	1.61"	1.81"	1.33"	1.32"	1.56"	1.13"

0-10V dims down to 1%, MLV/ELV/TRIAC dims down to 1%. For a complete list of compatible dimmers, see [Compatible Dimming Chart](#) on the Resources page.

**0-10V Dimming Power Supplies 0.1% 120VAC - 277VAC**

MODEL	POWER	OUTPUT	DIMMING
PS010V - 0-10V Power Supply dims down to 0.1%	96 - 96 Watt 3X96 - 3 X 96 Watt	24 - 24 VDC	LIN - Linear LOG - Logarithmic

MODELS	96W	3X96
<b>Length</b>	14.40"	15.75"
<b>Width</b>	5.20"	6.62"
<b>Depth</b>	2.60"	4.95"

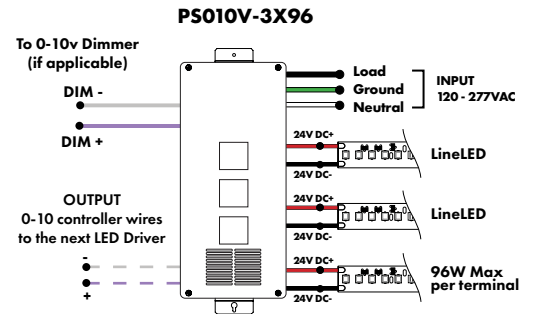
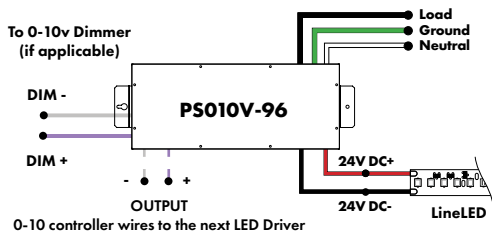

**Triac, MLV, & ELV Compatible Dimmers**

MODEL	POWER	OUTPUT
PDC - (IP20) Power Supply	96 - 96 Watts	24 - 24 VDC

MODELS	96W
<b>Length</b>	8.25"
<b>Width</b>	4.10"
<b>Depth</b>	1.56"

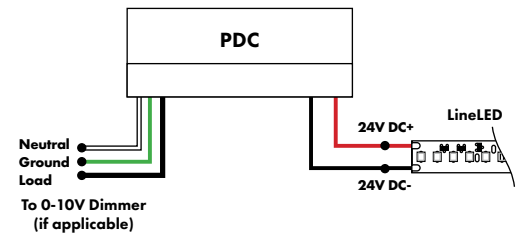

**Athena 0-10V LED Driver**

MODEL	INPUT CONTROL	ENVIRONMENT	WATTAGE	OUTPUT	FEATURE
PS-Power Supply, 120-277VAC	010V-LIN-0-10V Dimming, Linear 010V-LOG 0-10V Dimming, Logarithmic	D-Dry	96-96 W	24-24 VDC	AWN-R-Athena

MODELS	96W
<b>Length</b>	14.40"
<b>Width</b>	5.20"
<b>Depth</b>	2.60"

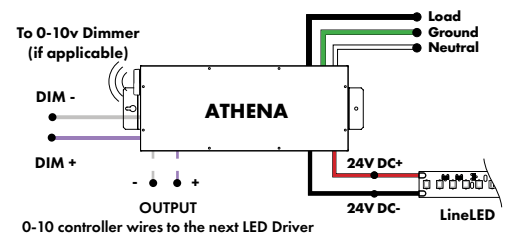

**Power Supplies**

See Power Supply instructions and spec sheet for wiring information. For a complete list of compatible dimmers, see Compatible Dimming Chart on the Resources page.

**DMX Dimming Power Supplies 120VAC - 277VAC**

MODEL	POWER	OUTPUT
PSDMX - DMX Power Supply dims down to 0%	96 - 96 Watt 3X96 - 3 X 96 Watt	24 - 24 VDC

Features eldoLED's LINEARdrive configurable dimmable drivers

MODELS	96W	3X96
<b>Length</b>	14.40"	15.75"
<b>Width</b>	5.20"	6.62"
<b>Depth</b>	2.60"	4.95"

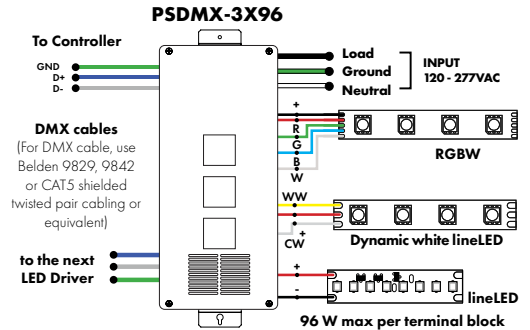
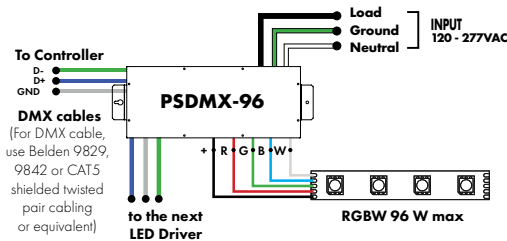

**DALI 0% Dimming Power Supplies 120VAC - 277VAC**

MODEL	POWER	OUTPUT
PSDALI - DALI Power Supply dims down to 0%	96 - 96 Watt 3X96 - 3 X 96 Watt	24 - 24 VDC

Features eldoLED's LINEARdrive configurable dimmable drivers

Model	96W	3X96
<b>Length</b>	14.40"	15.75"
<b>Width</b>	5.20"	6.62"
<b>Depth</b>	2.60"	4.95"

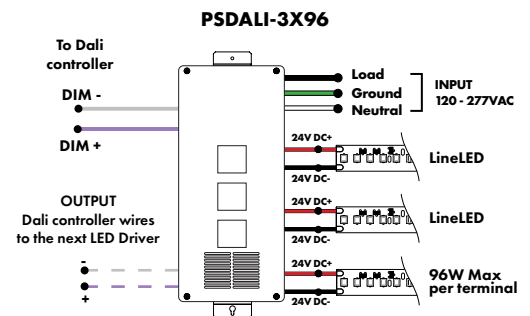
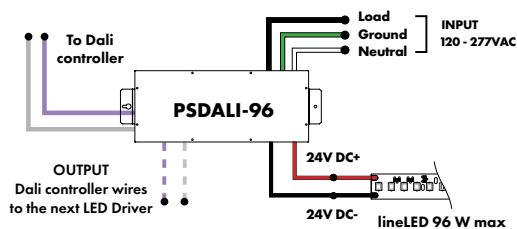

**Enlighted Enabled Dimming Power Supplies 120VAC - 277VAC**

MODEL	POWER	OUTPUT	DIMMING	LOCATION
PSV - PSV Series	96 - 96 Watt	24 - 24 VDC	ENL - Enlighted Dimming dims down to 0%	D - Damp

Model	96W
<b>Length</b>	14.40"
<b>Width</b>	5.20"
<b>Depth</b>	2.60"

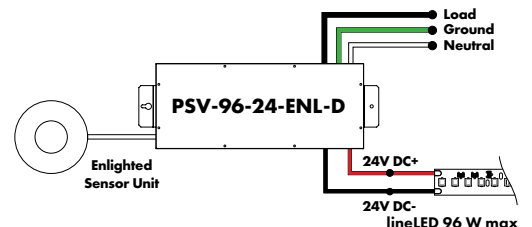

### Power Supplies

See Power Supply instructions and spec sheet for wiring information. For a complete list of compatible dimmers, see Compatible Dimming Chart on the Resources page.

#### Non-Dimming Power Supply 120VAC - 277VAC

MODEL	POWER	OUTPUT	DIMMING	LOCATION
PSV - PSV Series	96 - 96 Watt	24 - 24 VDC	ND - Non Dimming	D - Damp

MODELS	96W
Length	14.40"
Width	5.20"
Depth	2.60"

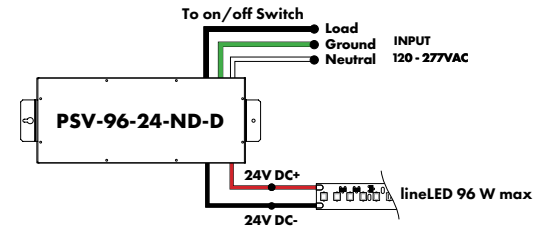

Luminii is a Lutron OEM Advantage Partner

#### Lutron Power Supplies 1%

MODEL
L3DA4U1UKL-CV240

HiLume™ 1% EcoSystem Voltage LED driver  
40W max

MODELS	L3DA4U1UKL-CV240
Length	4.98"
Width	4.00"
Depth	2.62"

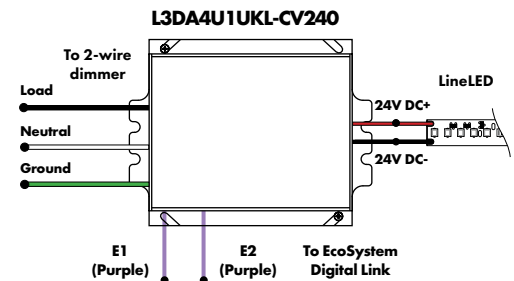

Luminii is a Lutron OEM Advantage Partner

#### Lutron Power Supplies 0.1%

MODEL
L3D0-96W24V-U

HiLume™ 0.1% EcoSystem Voltage LED Driver with Soft-On, Fade-to-Black™  
96W max

MODELS	L3D0
Length	10.50"
Width	5.50"
Depth	2.00"

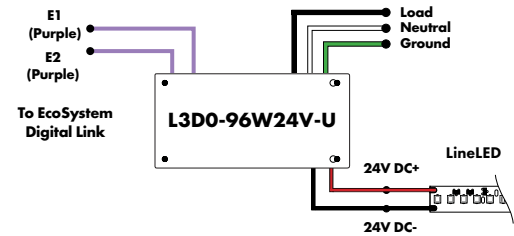

#### In-Ground Power Supplies

MODEL	POWER	OUTPUT	INPUT
IG - In ground CVE Series	CVE - ELV Dimming	96X2 - 2 X 96 Watt	Blank - 120 V 277 - 240/277 V

Dims down to 0%

MODELS	Dual Circuit
Length	8.40"
Width	8.30"
Depth	8.10"

