

# MINIMO PRO

WITH PRECISION WARM DIM LIGHT ENGINE



## KEY FEATURES

- Fixed or 35° adjustable tilt
- Tool-less site changeable optics
- Single channel COB light engine
- Beveled or Pinhole aesthetic
- Trimmed or Trimless

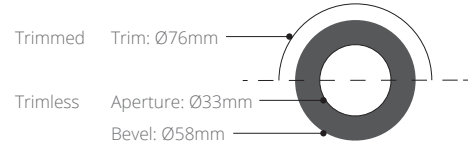

Minimo Pro features the all-new Precision Warm Dim light engine: Precision Warm Dim delivers an incandescent mimicking dim curve, warming from 3000K to 1800K through a single source color-mixing TIR optic. This is a constant current downlight machined from aerospace grade aluminum 6063-T6 and comes with a range of standard and premium finishes. It has four tool-less site changeable optics for flexible beam distribution. Minimo Pro has up to 35° tilt whilst the integral accessory holder can accommodate a lens or louver for additional glare control.

## PERFORMANCE DATA

<b>DELIVERED OUTPUT</b>	880lm (at 3000K)	<b>WATTAGE</b>	12.6W
<b>BEAM ANGLES</b>	25°   30°   40°   50°	<b>ELECTRICAL</b>	36V   350mA
<b>CCT</b>	1800K - 3000K	<b>DRIVER LOCATION</b>	Remote
<b>CRI</b>	94TYP at 3000K	<b>REMOTE DRIVERS</b>	DALI   0-10V
<b>TM-30</b>	RF: 92 RG: 99 (at 3000K)	<b>ACCESSORIES</b>	Louver   Lenses
<b>BINNING</b>	3 SDCM	<b>ACCESSORY HOLDER</b>	Integral
<b>LIFETIME</b>	L90 50,000 hrs min	<b>TM65</b>	13.09kgCO2e
<b>WARRANTY</b>	5 Years	<b>TM66</b>	2.2

## MECHANICAL & MOUNTING

<b>LOCATION</b>	IP20   IP54 available	<b>MOUNTING</b>	Recessed
<b>ADJUSTABILITY</b>	Fixed or 35° Tilt, 360° Rotation	<b>CEILING THICKNESS</b>	3-25mm
<b>OPTICS</b>	Site Changeable	<b>CUTOUT</b>	65mm
<b>WEIGHT</b>	250g	<b>MIN VOID HEIGHT</b>	130mm
<b>MATERIAL</b>	Machined AL 6063-T6		

## BEVELED APERTURE ORDER CODE

TRIM TYPE	FUNCTION	TRIM FINISH	APERTURE FINISH	CCT	BEAM ANGLE
RCD- Trimmed RCT- Trimless	FIXED 631W- IP20 633W- IP54	X Trimless W White RAL9010 B Black RAL9005 A Brushed Aluminium R Rubbed Bronze <sup>1</sup> P Polished Brass <sup>1</sup> S Brushed Brass <sup>1</sup> C Polished Chrome <sup>1</sup>	W- White RAL9010 B- Black RAL9005 G- Matt Gold Paint	W01 1800K-3000K	ME Medium 25°
					WD Wide 30°
	ADJUSTABLE 635W- IP20 637W- IP54				VW Very Wide 40°
					UW Ultra Wide 50°

## PINHOLE APERTURE ORDER CODE

TRIM TYPE	FUNCTION	TRIM FINISH	APERTURE FINISH	CCT	BEAM ANGLE
RCD- Trimmed RCT- Trimless	FIXED 632W- IP20 634W- IP54	X Trimless W White RAL9010 B Black RAL9005	W- White RAL9010 B- Black RAL9005	W01 1800K-3000K	ME Medium 25°
					WD Wide 30°
	ADJUSTABLE 636W- IP20 638W- IP54				VW Very Wide 40°
					UW Ultra Wide 50°

<sup>1</sup>: Premium & custom finishes are built to order, subject to an extended lead time.

Code example  
RCD-635W-BG-W01ME

## DRIVER ORDER CODE

PSCC-20-350-A-EL 0-10V Dim 0.1%

PSCC-20-350-D-EL DALI Dim 0.1%

Need a dimming protocol not listed here?  
Contact us for our extended range of driver options

# MINIMO PRO

WITH PRECISION WARM DIM LIGHT ENGINE

## TRIM & APERTURE TYPES



TRIMMED  
PINHOLE



TRIMLESS  
PINHOLE



TRIMMED  
BEVELED



TRIMLESS  
BEVELED

## TRIM FINISHES

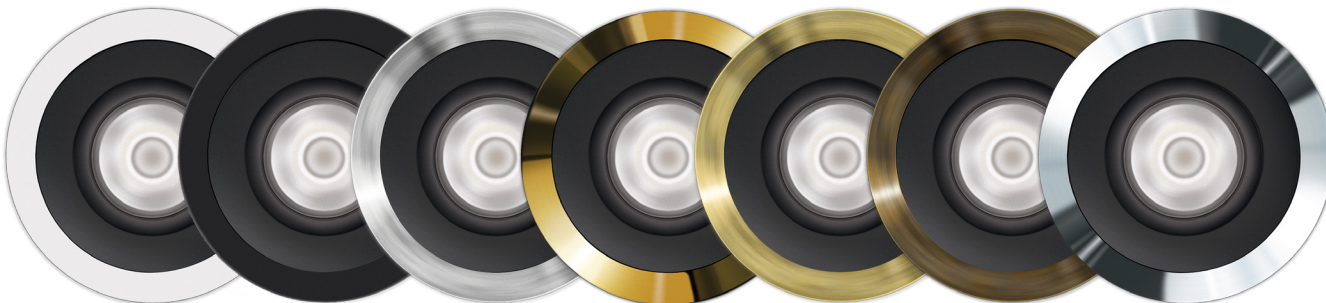

WHITE

BLACK

BRUSHED  
ALUMINUM

POLISHED  
BRASS

BRUSHED  
BRASS

RUBBED  
BRONZE

POLISHED  
CHROME

## APERTURE FINISHES

### BEVELED

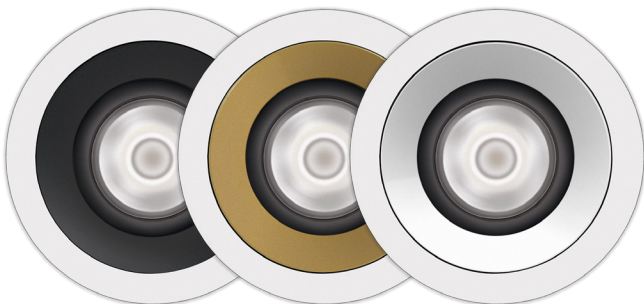

BLACK

MATTE GOLD

WHITE

### PINHOLE



WHITE

BLACK

MINIMO PRO

WITH PRECISION WARM DIM LIGHT ENGINE

DIMENSIONS

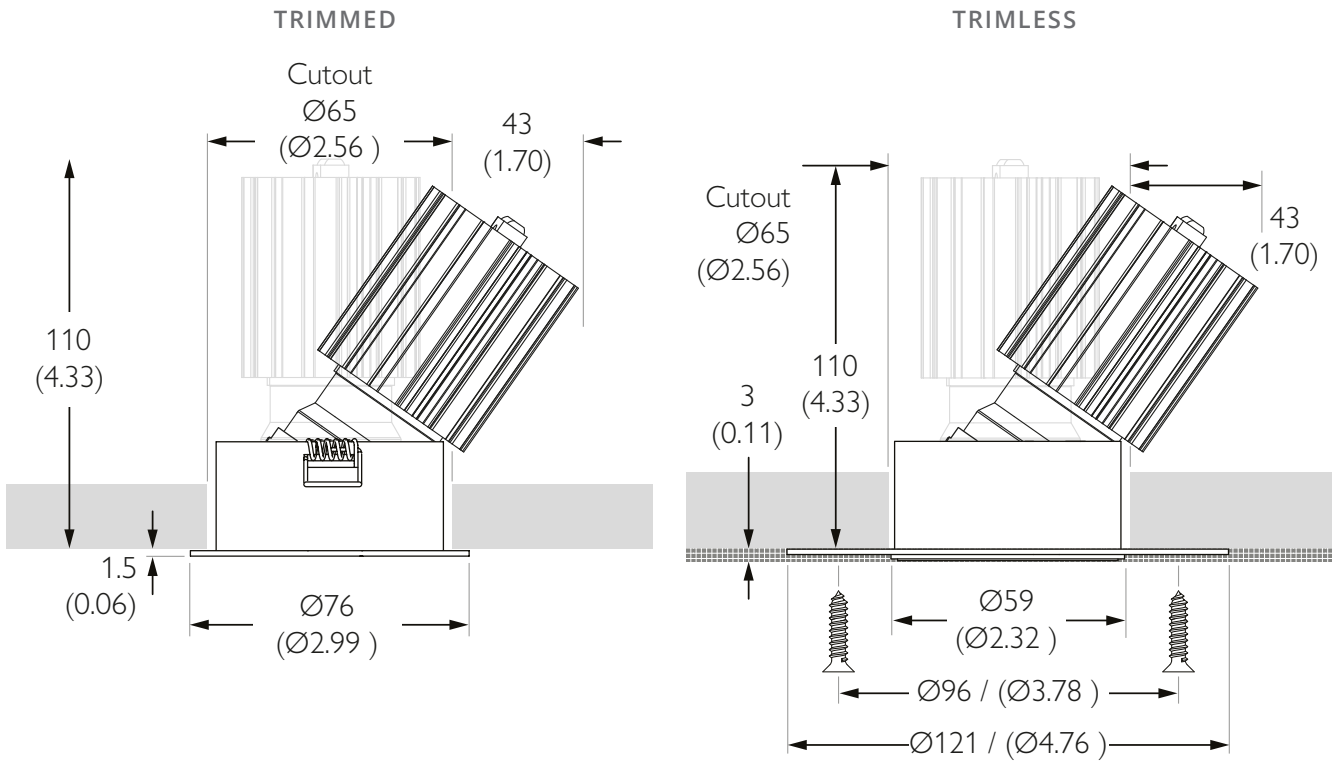

REMOTE DRIVER DETAIL

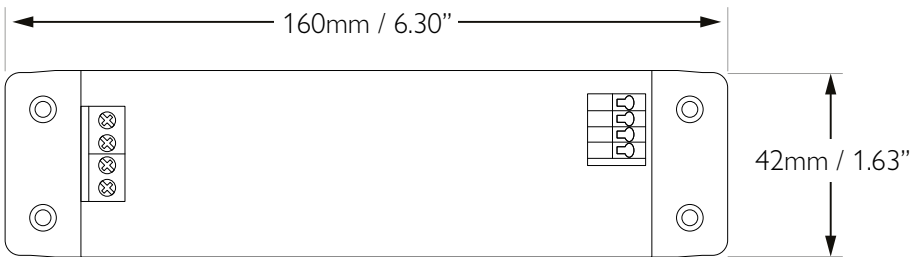

Dimming Type	0-10V
Min Dim Level	0.1%
Voltage In	230V
Manufacturer	Eldoled
Code	PSCC-20-350-A-EL
Dimming Type	DALI
Min Dim Level	0.1%
Voltage In	230V
Manufacturer	Eldoled
Code	PSCC-20-350-D-EL

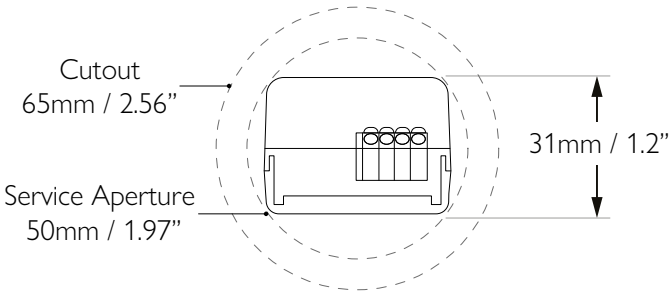

# MINIMO PRO

WITH PRECISION WARM DIM LIGHT ENGINE

## OUTPUT SCALING

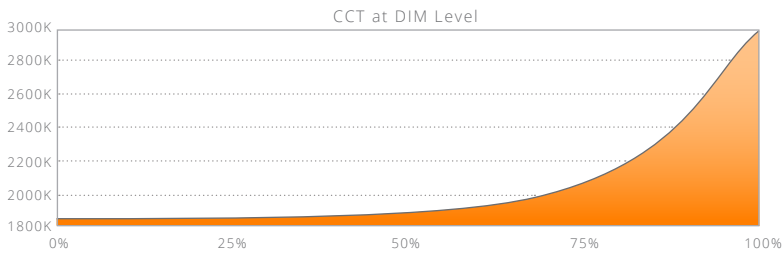

All diagrams and data measured at 3000K.

## PHOTOMETRY

### MEDIUM BEAM

BEAM ANGLE 25°  
DELIVERED LUMENS 878lm  
UGR 15.3  
PEAK INTENSITY 3306cd

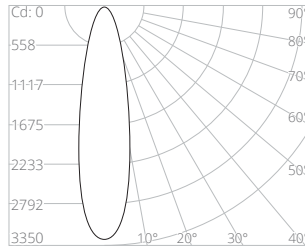
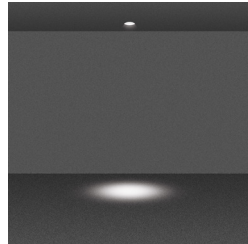

1m	0.44m	3306lx	367fc	1.3ft	3ft
2m	0.89m	827lx	92fc	2.7ft	6ft
3m	1.33m	367lx	41fc	4.0ft	9ft
4m	1.77m	207lx	23fc	5.3ft	12ft
5m	2.22m	132lx	15fc	6.7ft	15ft
			10fc	8.0ft	18ft

### WIDE BEAM

BEAM ANGLE 30°  
DELIVERED LUMENS 865lm  
UGR 14.9  
PEAK INTENSITY 2657cd

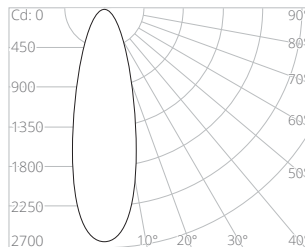
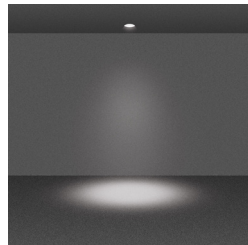

1m	0.54m	2657lx	295fc	1.6ft	3ft
2m	1.07m	664lx	74fc	3.2ft	6ft
3m	1.61m	295lx	33fc	4.8ft	9ft
4m	2.14m	166lx	18fc	6.4ft	12ft
5m	2.68m	106lx	12fc	8.0ft	15ft
			8fc	9.6ft	18ft

### VERY WIDE BEAM

BEAM ANGLE 40°  
DELIVERED LUMENS 867lm  
UGR 15.8  
PEAK INTENSITY 1804cd

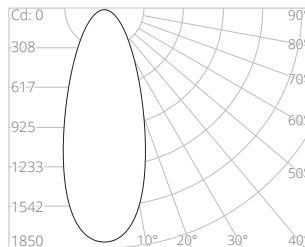
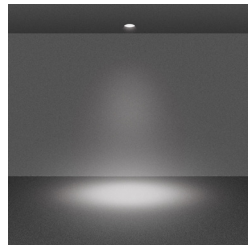

1m	0.73m	1804lx	200fc	2.2ft	3ft
2m	1.46m	451lx	50fc	4.4ft	6ft
3m	2.18m	200lx	22fc	6.6ft	9ft
4m	2.91m	113lx	13fc	8.7ft	12ft
5m	3.64m	72lx	8fc	10.9ft	15ft
			6fc	13.1ft	18ft

### ULTRA WIDE BEAM

BEAM ANGLE 50°  
DELIVERED LUMENS 755lm  
UGR 19.8  
PEAK INTENSITY 1005cd

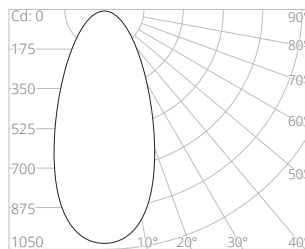
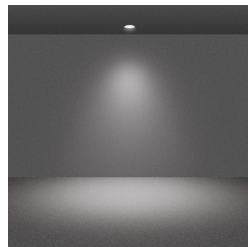

1m	0.93m	1005lx	112fc	2.8ft	3ft
2m	1.87m	251lx	28fc	5.6ft	6ft
3m	2.80m	112lx	12fc	8.4ft	9ft
4m	3.73m	63lx	7fc	11.2ft	12ft
5m	4.66m	40lx	4fc	14.0ft	15ft
			3fc	16.8ft	18ft

# MINIMO PRO

WITH PRECISION WARM DIM LIGHT ENGINE

## ACCESSORIES

The Minimo Pro can accommodate 1 accessory with no additional holder required as standard.

### Honeycomb Louver

*Enhances glare control*

THICKNESS 3.2mm

DAIMETER 32mm

PART CODE 995-32-BK

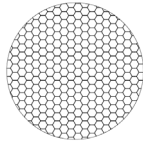

### 1/4 CTO Dichroic

*CCT warming - approx 300K*

THICKNESS 1.8mm

DAIMETER 32mm

PART CODE 997-1/4CTO-32



## LUMINAIRE MODULE DETAILS

