

MINIMO PRO

WITH PRECISION PLUS LIGHT ENGINE



KEY FEATURES

- Fixed or 35° adjustable tilt
- Tool-less site changeable optics
- High power COB light engine
- Ultra high CRI and R9
- Beveled or Pinhole aesthetic
- Trimmed or Trimless

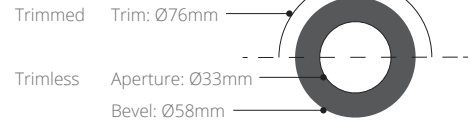

Minimo Pro features the all-new Precision Plus light engine: Precision Plus offers specifiers the option of 1000+ lumen and ultra-high CRI (98CRI & 90+ R9) all through a single source TIR optic. This is a constant current downlight machined from aerospace grade aluminum 6063-T6 and comes with a range of standard and premium finishes. It has four tool-less site changeable optics for flexible beam distribution. Minimo Pro has up to 35° tilt whilst the integral accessory holder can accommodate a lens or louver for additional glare control.

PERFORMANCE DATA

DELIVERED OUTPUT	1000lm (at 3000K)	WATTAGE	12.6W
BEAM ANGLES	19° 25° 37° 50°	ELECTRICAL	18V 700mA
CCT	2400K 2700K 3000K 4000K	DRIVER LOCATION	Remote
CRI	92TYP - 2400K 98TYP - 2700K/3000K 95TYP - 4000K	REMOTE DRIVERS	DALI 0-10V
TM-30	R9: 95 RF: 95 RG: 101 (at 3000K)	ACCESSORIES	Louver Lenses
BINNING	2 SDCM	ACCESSORY HOLDER	Integral
LIFETIME	L90 50,000 hrs min	TM65	13.09kgCO2e
WARRANTY	5 Years	TM66	2.2

MECHANICAL & MOUNTING

LOCATION	IP20 IP54 available	MOUNTING	Recessed
ADJUSTABILITY	Fixed or 35° Tilt, 360° Rotation	CEILING THICKNESS	3-25mm
OPTICS	Site Changeable	CUTOUT	65mm
WEIGHT	250g	MIN VOID HEIGHT	130mm
MATERIAL	Machined AL 6063-T6		

BEVELED APERTURE ORDER CODE

TRIM TYPE	FUNCTION	TRIM FINISH	APERTURE FINISH	CCT	BEAM ANGLE
RCD- Trimmed RCT- Trimless	FIXED 631C- IP20 633C- IP54	X Trimless W White RAL9010 B Black RAL9005 A Brushed Aluminium R Rubbed Bronze ¹ P Polished Brass ¹ S Brushed Brass ¹ C Polished Chrome ¹	W- White RAL9010 B- Black RAL9005 G- Matt Gold Paint	2492 2400K 2798 2700K 3098 3000K	NA Narrow 19° ME Medium 25° WD Wide 37° VW Very Wide 50°

PINHOLE APERTURE ORDER CODE

TRIM TYPE	FUNCTION	TRIM FINISH	APERTURE FINISH	CCT	BEAM ANGLE
RCD- Trimmed RCT- Trimless	FIXED 632C- IP20 634C- IP54	X Trimless W White RAL9010 B Black RAL9005	W- White RAL9010 B- Black RAL9005	2492 2400K 2798 2700K 3098 3000K	NA Narrow 19° ME Medium 25° WD Wide 37° VW Very Wide 50°

¹: Premium & custom finishes are built to order, subject to an extended lead time.

Code example
RCD-635C-BG-2798ME

DRIVER ORDER CODE

PSCC-20-700-A-EL 0-10V Dim 0.1%

PSCC-20-700-D-EL DALI Dim 0.1%

Need a dimming protocol not listed here?
Contact us for our extended range of driver options

TRIM & APERTURE TYPES



TRIMMED
PINHOLE



TRIMLESS
PINHOLE



TRIMMED
BEVELED



TRIMLESS
BEVELED

TRIM FINISHES

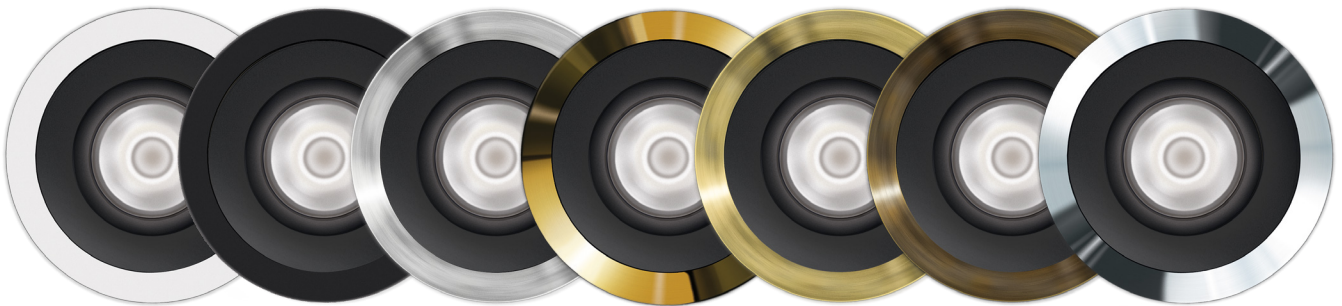

WHITE

BLACK

BRUSHED
ALUMINUM

POLISHED
BRASS

BRUSHED
BRASS

RUBBED
BRONZE

POLISHED
CHROME

APERTURE FINISHES

BEVELED



BLACK

MATTE GOLD

WHITE

PINHOLE



WHITE

BLACK

MINIMO PRO

WITH PRECISION PLUS LIGHT ENGINE

DIMENSIONS

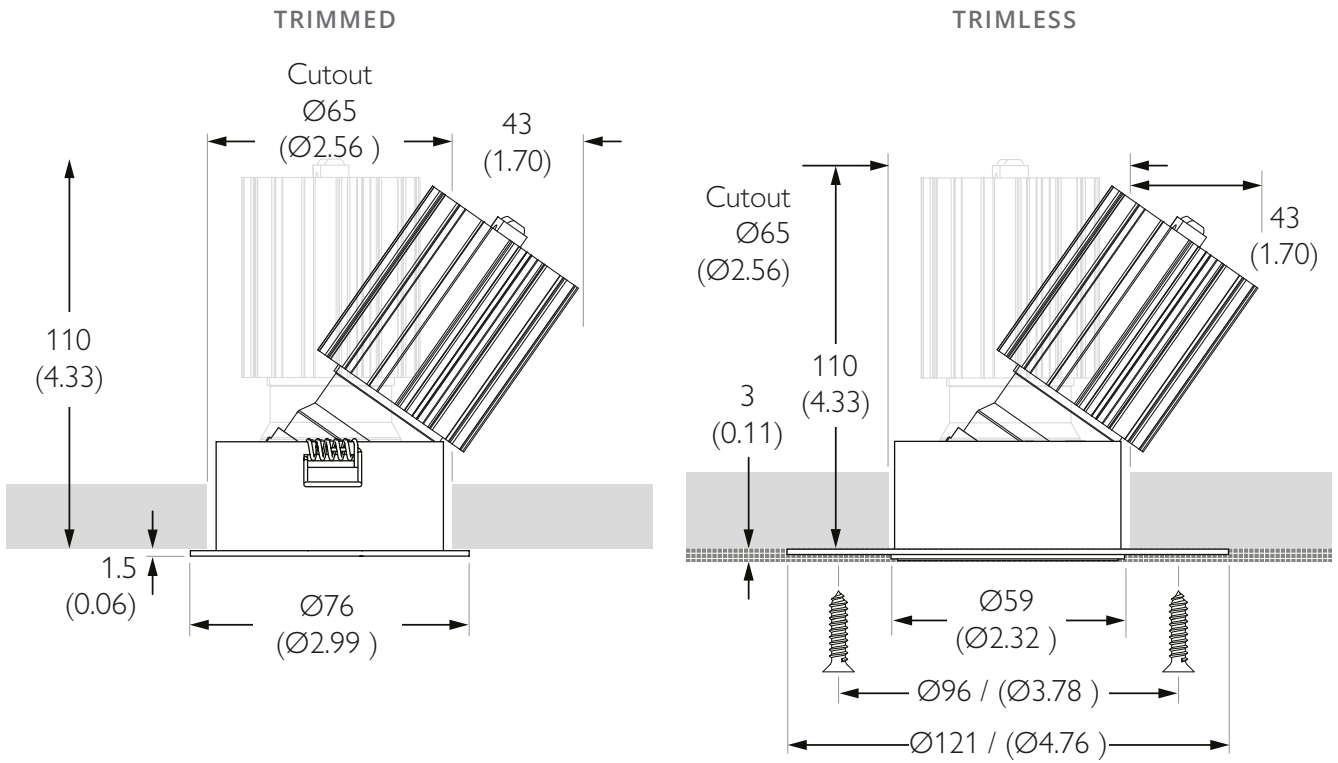

REMOTE DRIVER DETAIL

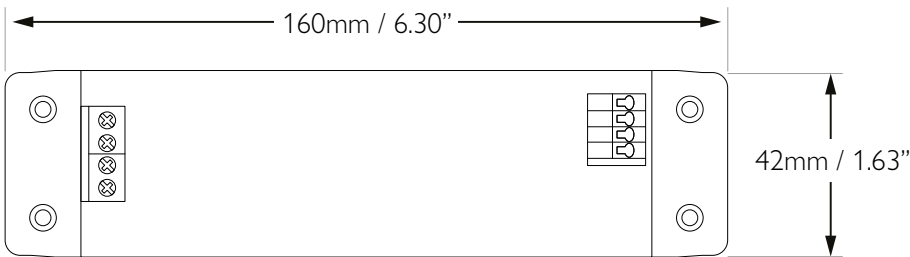

Dimming Type 0-10V
 Min Dim Level 0.1%
 Voltage In 230V
 Manufacturer Eldoled
 Code PSCC-20-700-A-EL

Dimming Type DALI
 Min Dim Level 0.1%
 Voltage In 230V
 Manufacturer Eldoled
 Code PSCC-20-700-D-EL

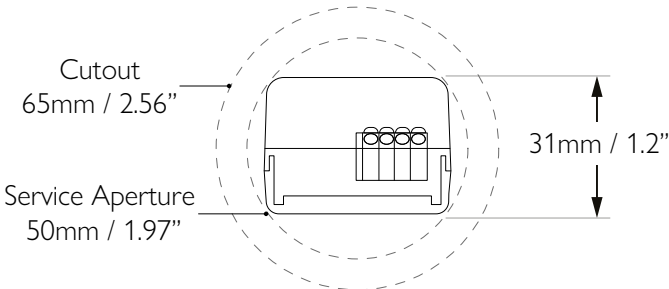

MINIMO PRO

WITH PRECISION PLUS LIGHT ENGINE

OUTPUT SCALING

CCT	Multiplier	CRI	R9	Rf	Rg	Max Delivered lm
2400K	0.97	92	90	90	99	970lm
2700K	0.93	98	95	95	101	931lm
3000K	1.00	98	95	95	100	1001lm
3500K	1.05	98	95	95	99	1051lm
4000K	1.05	95	90	90	99	1051lm

All diagrams and data measured at 3000K.

PHOTOMETRY

NARROW BEAM

BEAM ANGLE 19°
DELIVERED LUMENS 887lm
UGR 12.2
PEAK INTENSITY 6389cd

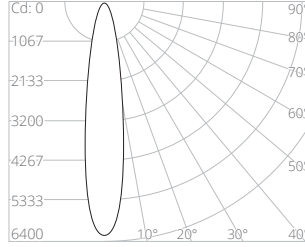
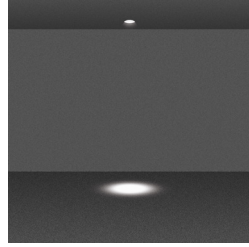

Height	Beam Diameter	Peak Intensity (lx)	Footcandle (fc)	Height (ft)	Beam Diameter (ft)
1m	0.33m	6389lx	710fc	1.0ft	3ft
2m	0.67m	1597lx	177fc	2.0ft	6ft
3m	1.00m	710lx	79fc	3.0ft	9ft
4m	1.34m	399lx	44fc	4.0ft	12ft
5m	1.67m	256lx	28fc	5.0ft	15ft
			20fc	6.0ft	18ft

MEDIUM BEAM

BEAM ANGLE 25°
DELIVERED LUMENS 1001lm
UGR 12.3
PEAK INTENSITY 5069cd

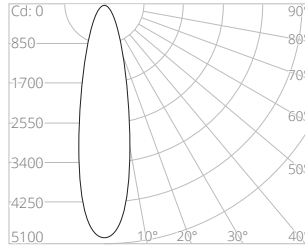
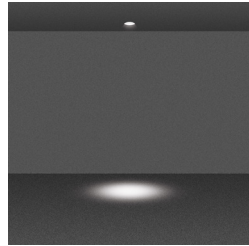

Height	Beam Diameter	Peak Intensity (lx)	Footcandle (fc)	Height (ft)	Beam Diameter (ft)
1m	0.44m	5069lx	563fc	1.3ft	3ft
2m	0.89m	1267lx	141fc	2.7ft	6ft
3m	1.33m	563lx	63fc	4.0ft	9ft
4m	1.77m	317lx	35fc	5.3ft	12ft
5m	2.22m	203lx	23fc	6.7ft	15ft
			16fc	8.0ft	18ft

WIDE BEAM

BEAM ANGLE 37°
DELIVERED LUMENS 997lm
UGR 12.4
PEAK INTENSITY 2473cd

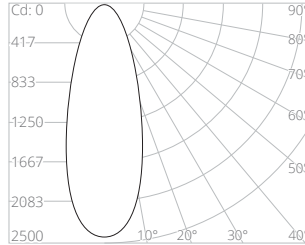
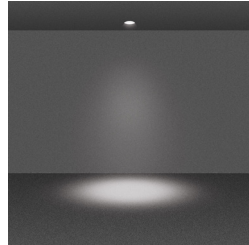

Height	Beam Diameter	Peak Intensity (lx)	Footcandle (fc)	Height (ft)	Beam Diameter (ft)
1m	0.67m	2473lx	275fc	2.0ft	3ft
2m	1.34m	618lx	69fc	4.0ft	6ft
3m	2.01m	275lx	31fc	6.0ft	9ft
4m	2.68m	155lx	17fc	8.0ft	12ft
5m	3.35m	99lx	11fc	10.0ft	15ft
			8fc	12.0ft	18ft

VERY WIDE BEAM

BEAM ANGLE 50°
DELIVERED LUMENS 912lm
UGR 19.9
PEAK INTENSITY 1537cd

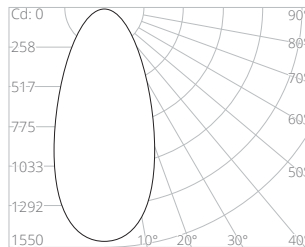
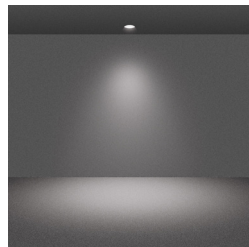

Height	Beam Diameter	Peak Intensity (lx)	Footcandle (fc)	Height (ft)	Beam Diameter (ft)
1m	0.93m	1537lx	171fc	2.8ft	3ft
2m	1.87m	384lx	43fc	5.6ft	6ft
3m	2.80m	171lx	19fc	8.4ft	9ft
4m	3.73m	96lx	11fc	11.2ft	12ft
5m	4.66m	61lx	7fc	14.0ft	15ft
			5fc	16.8ft	18ft

MINIMO PRO

WITH PRECISION PLUS LIGHT ENGINE

ACCESSORIES

The Minimo Pro can accommodate 1 accessory with no additional holder required as standard.

Honeycomb Louver

Enhances glare control

THICKNESS 3.2mm

DAIMETER 32mm

PART CODE 995-32-BK

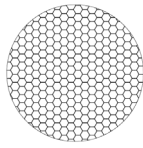

1/4 CTO Dichroic

CCT warming - approx 300K

THICKNESS 1.8mm

DAIMETER 32mm

PART CODE 997-1/4CTO-32



LUMINAIRE MODULE DETAILS

