

# LETO 44 MINI

## WALL MOUNT CYLINDER



### Features

- Faceted metal reflectors provide beam spreads between 20° to 60°.
- Three output options available up to 1500 lumens.
- Nine drivers selections available to cover wide range of applications.
- Five year warranty.



### Finish Options

- White
- Silver
- Mocha
- Firebrick
- Warm Nickel
- Black
- Charcoal
- Cerulean
- Bronze
- Aged Brass

### Technical Information

OUTPUT OPTIONS	700 lm	1000 lm	1500 lm
<b>Size</b>	S/M/L	S/M/L	S/M/L
<b>Fixture wattage</b>	6.5 W	9.8 W	14.8 W
<b>Delivered Lumen</b>	693 lm	1030 lm	1450 lm
<b>Efficacy</b>	107 lm/W	105 lm/W	98 lm/W
<b>Center Beam Candlepower (20° Faceted Reflector)</b>	1985 cd	2951 cd	4128 cd

CCT	Multiplier	CRI	TM-30		
			R <sub>f</sub>	R <sub>g</sub>	R <sub>9</sub>
2500K	0.80	93+	93	102	50+
2700K	0.92	93+	92	100	50+
3000K	0.97	93+	92	103	50+
3500K	1.00	93+	93	102	50+
4000K	1.07	93+	92	101	50+
6500K	1.05	93+	92	101	50+

Integral Driver Example: Fixture LET44M-WM-S-07-25K-F20-NA-WH-WH-RDS-WH-PHSD-NA

Remote Driver Example: Fixture LET44M-WM-S-07-25K-F20-NA-WH-WH-RDS-WH-PHSD-NA-HRM-LET44M-WM-07-25K-PHSD-NA

### Ordering Code

#### Fixture

MODEL	TYPE	SIZE	OUTPUT	CCT	OPTIC	ACCESSORY	BODY FINISH	BAFFLE FINISH
LET44M-Leto 44 Mini	WM-Wall Mount	S-Small M-Medium L-Large	07-700 lumens (6.5W) 10-1000 lumens (9.8W) 15-1500 lumens (14.8W)	25K-2500K 27K-2700K 30K-3000K 35K-3500K 40K-4000K 65K-6500K	F20-20 Degree, Faceted F30-30 Degree, Faceted F60-60 Degree, Faceted	NA-No Accessory DL-Diffusing Lens HC-Honeycomb Louver <sup>1</sup>	Standard WH-White BK-Black S-Silver  Premium <sup>2</sup> MA-Mocha CC-Charcoal CR-Cerulean FB-Firebrick BZ-Bronze WN-Warm Nickel AB-Aged Brass	Standard WH-White BK-Black S-Silver  Premium <sup>2</sup> MA-Mocha CC-Charcoal CR-Cerulean FB-Firebrick BZ-Bronze WN-Warm Nickel AB-Aged Brass

CANOPY/ HOUSING	CANOPY FINISH	DRIVER	DRIVER OPTIONS <sup>7</sup>
RDS - Round Slim SQS - Square Slim SQR - Square Semi-Recessed <sup>3</sup>	Standard WH - White BK - Black S - Silver  Premium <sup>2</sup> MA - Mocha CC - Charcoal CR - Cerulean FB - Firebrick BZ - Bronze WN - Warm Nickel AB - Aged Brass	PHSD - Forward/Reverse Phase, 1% Dimming, 120V Only <sup>3</sup> 010S - 0-10V, 1% Dimming, 120/277V <sup>3</sup> 0103 - 0-10V, 1% Dimming, 347V Only <sup>3</sup> 010L - EldoLED, 0-10V, Linear, 0.1% Dimming, 120/277V <sup>5</sup> 010G - EldoLED, 0-10V, Log, 0.1% Dimming, 120/277V <sup>5</sup> DALI - EldoLED, DALI Protocol 2, DT-6, 0.1% Dimming, 120/277V <sup>5</sup> DALI8 - EldoLED, DALI Protocol 2, DT-8, 0.1% Dimming, 120/277V <sup>5</sup> LUTE - Lutron Hilume Ecodigital, 1% Dimming, 120V/277V <sup>4,5</sup> DMX - EldoLED, DMX, 0.1% Dimming, 120V/277V <sup>5</sup>	NA - None EMG - Emergency Driver <sup>6</sup>

1 - Size Small is not available with Accessory HC Honeycomb Louver.  
2 - Premium finishes may have extended lead times. Custom RALs are available, please consult Inside Sales with specific request.  
3 - SQR Canopy with PHSD/010S is not available with 700 lumens.  
4 - LUTE driver is not available at 700 lumens.

5 - Drivers 0103/010L/010G/DALI/DALI8/DMX/LUTE/EMG are only available with HRM - Remote Power Supply.  
6 - Emergency option comes prewired from factory with driver in remote housing. 8W of continuous power provided for a minimum of 90 minutes. Must be installed within 30 feet of luminaire using 18 AWG wire. Not available with 0103, DMX, DALI8 or LUTE Driver.  
7 - AWWNR/CSMB available upon request.

CONTACT FACTORY FOR MORE OPTIONS.

## Canopy

**RDS**  
Round Slim Canopy

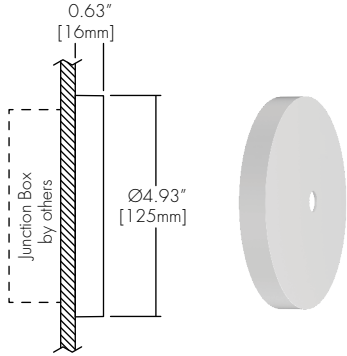

**SQS**  
Square Slim Canopy

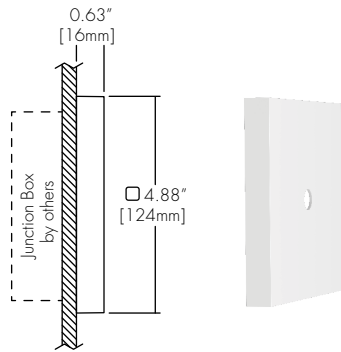

**SQR**  
Square Semi-Recessed

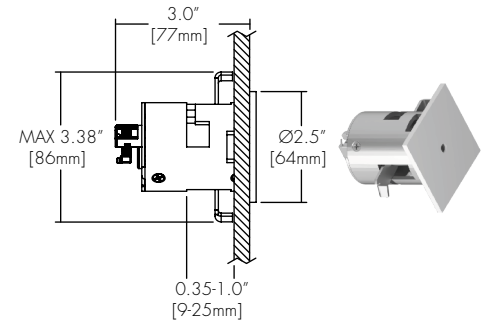

RDS or SQS	
Integral Drivers	PHSD, 010S
Remote Drivers	0103, 010L, 010G, DALI, DALI8, LUTE, DMX

SQR	
Integral Drivers	
Remote Drivers	PHSD, 010S, 0103, 010L, 010G, DALI, DALI8, LUTE, DMX

## Lens & Accessory Options

**DL**  
Diffusing Lens



**HC**  
Honeycomb



## Optics

**FXX** (20°, 30°, 60°)  
Faceted Reflector



## Remote Driver Housing

Depending on the options selected in the order code on page 1, a Remote Driver Housing may be required. This will automatically be generated and put on your order as necessary.

REMOTE DRIVER	MODEL	OUTPUT	CCT	DRIVER	DRIVER OPTIONS
HRM-Housing, Remote	LET44M-WM-Leto 44 Mini Wall Mount	Same as Fixture	Same as Fixture	Same as Fixture	Same as Fixture

Maximum mounting distance to luminaire using 18 AWG wire								
PHSD	010S	0103	010L	010G	DALI	DALI8	LUTE	DMX
16'	16'	16'	72'	72'	72'	72'	15'	149'

## 4" J-box

Minimum volume required to mount drivers in junction box: 70mm x 40mm x 30mm.

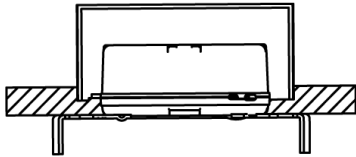

Canopy	+	Driver
RDS	+	PHSD
RDS	+	010S
SQS	+	PHSD
SQS	+	010S

## HRM Single with Externally Mounted Driver

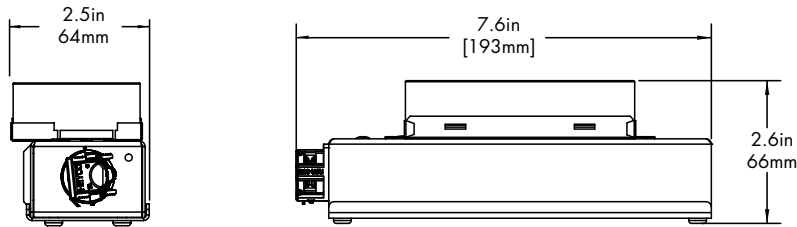

Driver
0103
010L
010G
010S
DALI
LUTE

## HRM Double

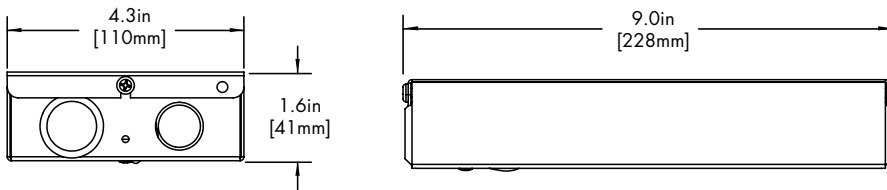

Driver
DALI8
DMX

## EMG Emergency Driver

120 minute EMG operation time.

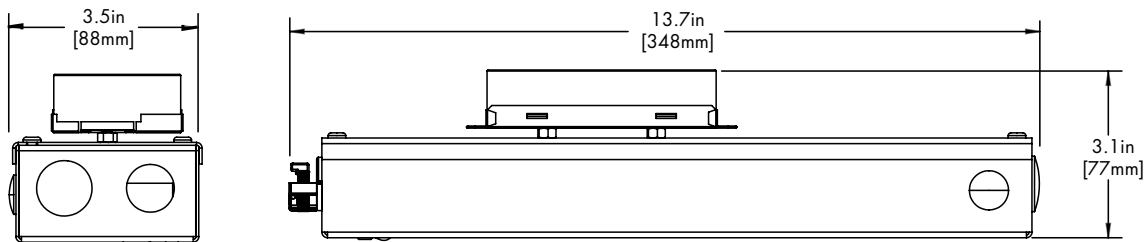

Driver
EMG

## Standard Finishes

**BK**  
Black



**WH**  
White



**SL**  
Silver



## Premium Finishes

**MA**  
Mocha



**CC**  
Charcoal



**CR**  
Cerulean

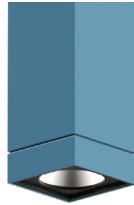

**FB**  
Firebrick

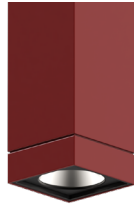

**BZ**  
Bronze



**WN**  
Warm Nickle



**AB**  
Antique Bronze



## TM-30

**2500K**

COLOR VECTOR GRAPHIC

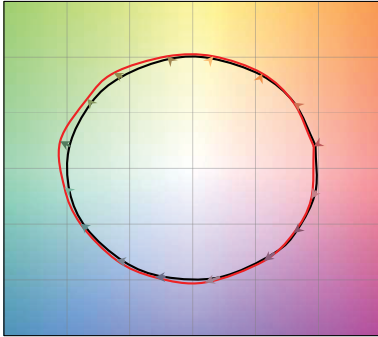

— Reference Source — Test Source

**2700K**

COLOR VECTOR GRAPHIC

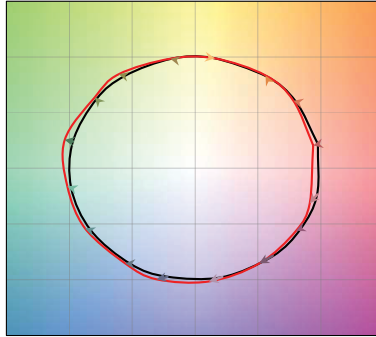

— Reference Source — Test Source

**3000K**

COLOR VECTOR GRAPHIC

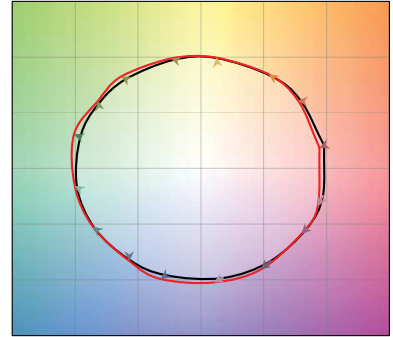

— Reference Source — Test Source

**3500K**

COLOR VECTOR GRAPHIC

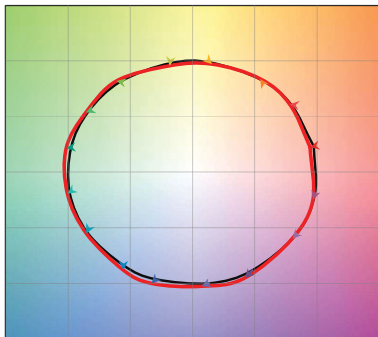

— Reference Source — Test Source

**4000K**

COLOR VECTOR GRAPHIC

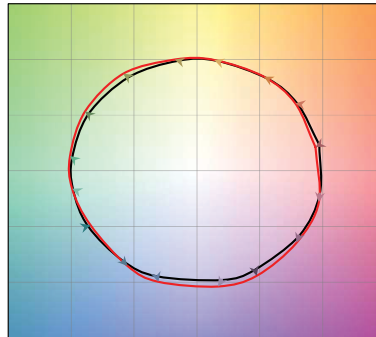

— Reference Source — Test Source

**6500K**

COLOR VECTOR GRAPHIC

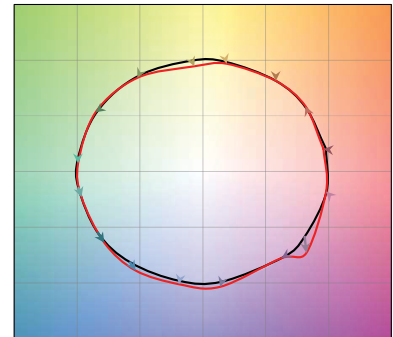

— Reference Source — Test Source

## Photometry

### 20° Faceted Reflector

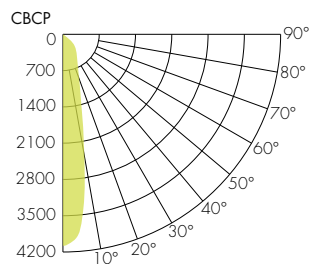
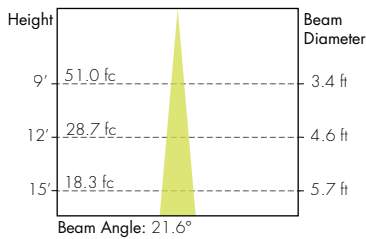

### 60° Faceted Reflector

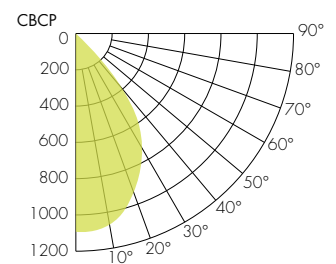
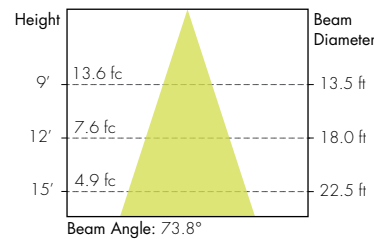

### 30° Faceted Reflector

