

LETO 11 ADJ

ADJUSTABLE SUSPENDED CYLINDER

TUNABLE WHITE & WARM DIM

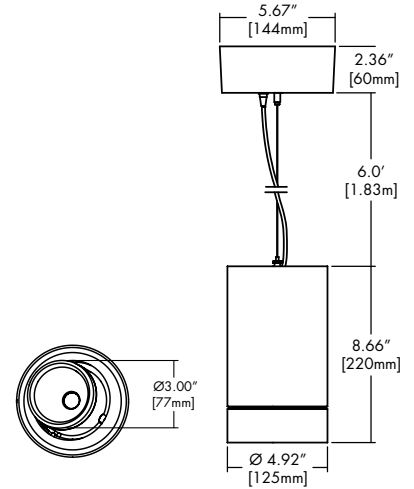

Features

- 360° rotation and up to 30° total tilt.
- Field interchangeable faceted metal reflectors provide adjustable beam spreads between 18° to 60°.
- Five output options available up to 3000 lumens.
- Nine driver selections available to cover wide range of applications.
- Five year warranty.

Finish Options

- White
- Mocha
- Black
- Charcoal
- Silver
- Cerulean
- Firebrick



Technical Information

TYPE	WD1830					TW2765	
	700 lm	1000lm	1500lm	2000lm	3000lm	1500lm	3000lm
OUTPUT OPTIONS							
Fixture wattage	7.2 W	11.4 W	16.4 W	21.6 W	32.5 W	12.9 W	34.4 W
Delivered Lumen	724 lm	1153 lm	1632 lm	2037 lm	2851 lm	1538 lm	3185 lm
Efficacy	101 lm/W	101 lm/W	100 lm/W	94 lm/W	88 lm/W	119 lm/W	93 lm/W
Center Beam Candlepower (18° Faceted Reflector)	4536 cd	5324 cd	7537 cd	9703 cd	13162 cd	6310 cd	13068 cd

CCT	TM-30			
	CRI	R _f	R _g	R ₉
1800K	94	90	93	61
3000K	94	89	97	72
2700K	91	90	96	59
6500K	93	87	97	73

Integral Driver Example: Fixture LET11A-S-07-WD1830-F18-NA-WH-WH-RD-WH-2AF-NA-PHSD-NA
 Remote Driver Example: Fixture LET11A-S-07-WD1830-F18-NA-WH-WH-RD-WH-2AF-NA-PHSD-NA
 HRM-LET11A-S-07-WD1830-PHSD-NA

Ordering Code

MODEL	TYPE	OUTPUT	CCT	OPTIC	ACCESSORY*	BODY FINISH	BAFFLE FINISH
LET11A - leto 11 Adjustable	S - Suspended	07 - 700 lumens 10 - 1000 lumens 15 - 1500 lumens 20 - 2000 lumens 30 - 3000 lumens	WD1830 - Warm Dim, 1800K-3000K TW2765 - Tunable White, 2700K-6500K ^{10,11,12}	F18 - 18 Degree, Faceted F30 - 30 Degree, Faceted F45 - 45 Degree, Faceted F60 - 60 Degree, Faceted	NA - No Accessory CL - Clear Lens DL - Diffusing Lens HC - Honeycomb Louver SL - Solite Lens	Standard WH - White BK - Black SL - Silver Premium ² MA - Mocha CC - Charcoal CR - Cerulean FB - Firebrick	Standard WH - White BK - Black SL - Silver Premium ² MA - Mocha CC - Charcoal CR - Cerulean FB - Firebrick
CANOPY/ HOUSING	CANOPY FINISH	SUSPENSION TYPE	SUSPENSION FINISH	DRIVER		DRIVER OPTIONS	
RD - Round RTL - Round Trimless ³ SQ - Square	Standard WH - White BK - Black SL - Silver Premium ² MA - Mocha CC - Charcoal CR - Cerulean FB - Firebrick	2AF - 2AC + Feed Cable SS2 - Solid Stem, 2ft SS3 - Solid Stem, 3ft SS6 - Solid Stem, 6ft HS2 - Hang Straight, 2ft ⁴ HS3 - Hang Straight, 3ft ⁴ HS6 - Hang Straight, 6ft ⁴ POA - 2 Powered Aircraft	Standard NA - None ⁵ CL - Clear WH - White BK - Black SL - Silver ⁵ Premium ² MA - Mocha ⁵ CC - Charcoal ⁵ CR - Cerulean ⁵ FB - Firebrick ⁵	PHSD - Forward/Reverse Phase, 1% Dimming, 120V Only 010S - 0-10V, 1% Dimming, 120V/277V 0103 - 0-10V, 1% Dimming, 347V Only 010L - EldoLED, 0-10V, Linear, 0.1% Dimming, 120V/277V ⁷ 010G - EldoLED, 0-10V, Log, 0.1% Dimming, 120V/277V ⁷ DALI - EldoLED, DALI Protocol 2, DT-6, 0.1% Dimming, 120V/277V ⁸ DALI8 - EldoLED, DALI Protocol 2, DT-8, 0.1% Dimming, 120V/277V ⁸ LUTE - Lutron Hilume Ecodigital, 1% Dimming, 120V/277V ^{1,7} DMX - EldoLED, DMX, 0.1% Dimming, 120V/277V ³		NA - None EMG - Emergency Driver ^{3,8} CSMB - Casambi ⁹ AWNR - Athena ⁹	

1 - LUTE driver is not available at 700 lumens.
 2 - Premium finishes may have extended lead times. Custom RALs are available, please consult Inside Sales with specific request.
 3 - All drivers remote mounted when using RTL canopy, DALI8 driver, DMX driver, or EMG driver options.
 4 - HS2/HS3/HS6 Suspension are not available with RTL Canopy.
 5 - These finishes are only available with SS Solid Stem or HS Hang Straight.
 6 - Must select NA None when POA 2 Powered Aircraft Suspension Type is selected.
 7 - Requires SQ square canopy for integral driver, otherwise remote mounted.
 8 - Emergency option comes prewired from factory with driver in remote housing. 8W of continuous power provided for a minimum of 90 minutes. Must be installed within 30 feet of luminaire using 18 AWG wire. Not available with 0103, DMX, DALI8 or LUTE Driver.
 9 - AWNR/CSMB only available with 010S driver and RD/SQ canopy.
 10 - TW2765 only available with 1500/3000 lumens.
 11 - TW2765 only available with Drivers 010L/010G/DALI8/DMX. Not available with EMG driver option.
 12 - TW2765 requires HRM - Remote Power Supply.

CONTACT FACTORY FOR MORE OPTIONS.

LETO 11 ADJ

ADJUSTABLE SUSPENDED CYLINDER
TUNABLE WHITE & WARM DIM

Canopy

RD Round Canopy

	Integral Drivers	Remote Drivers
 <p>2.36" 60mm</p> <p>Ø5.17" 131mm</p>	010S	010L
	0103	010G
	PHSD	DAI
		DAI8
		LUTE DMX

RTL Round Trimless Canopy

	Integral Drivers	Remote Drivers
 <p>Ø5.17" 131mm</p>	N/A	010S
		0103
		PHSD
		010L
		010G
		DAI
		DAI8
		LUTE
		DMX

SQ Square Canopy

	Integral Drivers	Remote Drivers
 <p>2.28" 58mm</p> <p>5.67" 144mm</p>	010S	DAI8
	0103	DMX
	PHSD	
	010L	
	010G	
	DAI	
	DAI8	
	LUTE	

Please see next page for Remote Driver Housing details.

Suspension

2AF 2 Aircraft + Feed Cable



SSX (2', 3', 6' max) Solid Stem



HSX (2', 3', 6' max) Hang Straight Solid Stem



Maximum Slope: 15°

POA 2 Powered Aircraft



Lens & Accessory Options

OPTC-ACC-CL-65MM

Clear Lens
Also available with complete fixture, use ordering code.
-CL



OPTC-ACC-DL-65MM

Diffusing Lens
Also available with complete fixture, use ordering code.
-DL



OPTC-ACC-HC-65MM

Honeycomb Lens
Also available with complete fixture, use ordering code.
-HC



OPTC-ACC-SL-65MM

Solite Lens
Also available with complete fixture, use ordering code.
-SL



Optics

RFLC-FXX-60MM

Faceted Reflector
Also available with complete fixture, use ordering code.
-F18/-F30/-F45/-F60



FXX	Optic
F18	18° Faceted
F30	30° Faceted
F45	45° Faceted
F60	60° Faceted

Remote Driver Housing

Depending on the options selected in the order code on page 1, a Remote Driver Housing may be required. This will automatically be generated and put on your order as necessary.

REMOTE DRIVER	MODEL	OUTPUT	CCT	DRIVER	DRIVER OPTIONS
HRM-Housing, Remote	LET11A-S-Leto 11 Adjustable Suspended	Same as Fixture	Same as Fixture	Same as Fixture	Same as Fixture

Maximum mounting distance to luminaire using 18 AWG wire								
PHSD	010S	0103	010L	010G	DALI	DALI8	LUTE	DMX
16'	16'	16'	72'	72'	72'	72'	15'	149'

HRM Single with Externally Mounted Driver

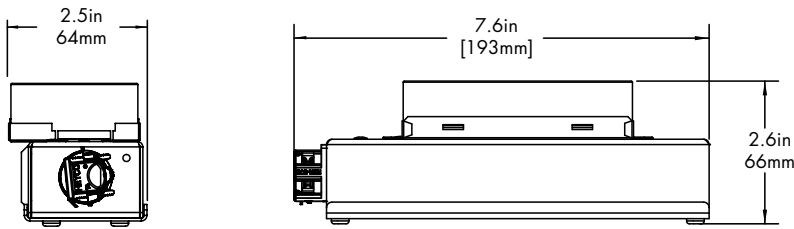

Canopy	+	Driver
RTL	+	0103
RD or RTL	+	010L
RD or RTL	+	010G
RD or RTL	+	DALI
RD or RTL	+	LUTE

HRM Single

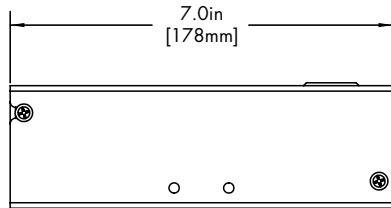
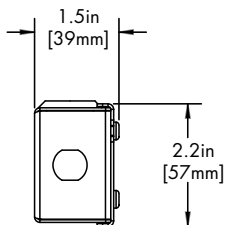

Canopy	+	Driver
RTL	+	PHSD
RTL	+	010S

HRM Double

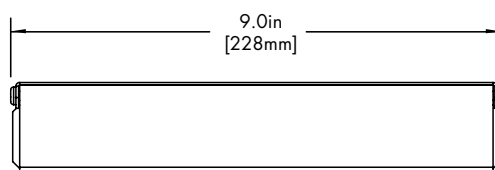
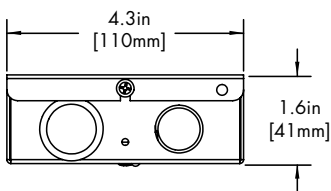

Driver
DALI8
DMX

EMG Emergency Driver

120 minute EMG operation time.

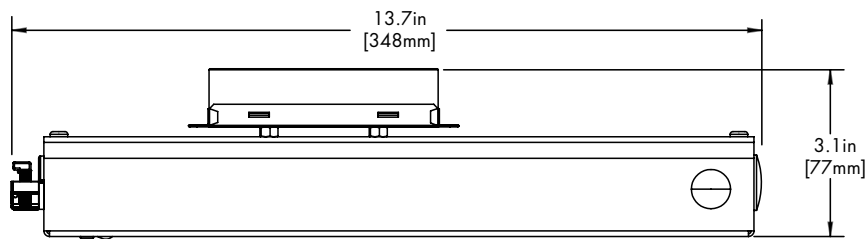
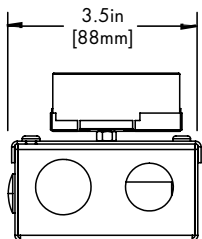

Driver
EMG

LETO 11 ADJ

ADJUSTABLE SUSPENDED CYLINDER
TUNABLE WHITE & WARM DIM

Standard Finish

BK
Black



WH
White



SL
Silver



Premium Finish

Two tone with Black Baffle Finish. Any combination may be used for baffle and body finishes.

MA
Mocha



CC
Charcoal



CR
Cerulean



FB
Firebrick



TM-30

Warm Dim 1800K

COLOR VECTOR GRAPHIC

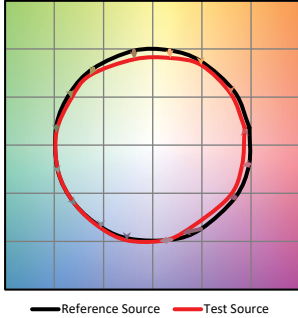

Warm Dim 3000K

COLOR VECTOR GRAPHIC

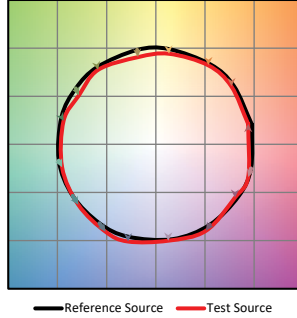

Tunable White 2700K

COLOR VECTOR GRAPHIC

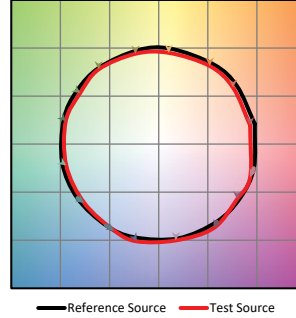

Tunable White 6500K

COLOR VECTOR GRAPHIC

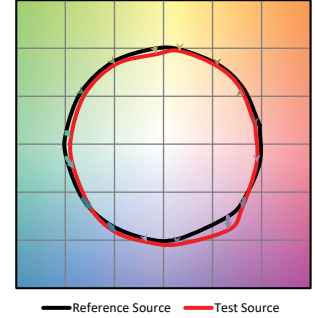

Photometry

18° Faceted Reflector

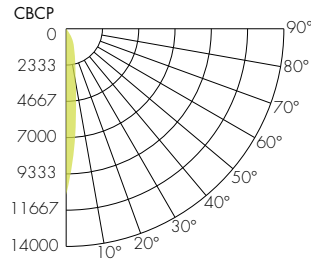
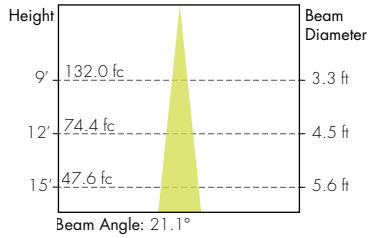

30° Faceted Reflector

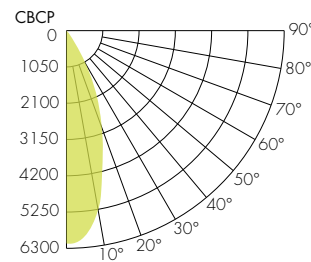
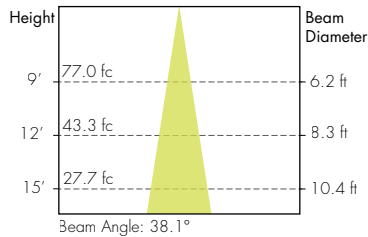

45° Faceted Reflector

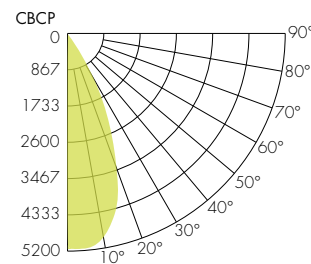
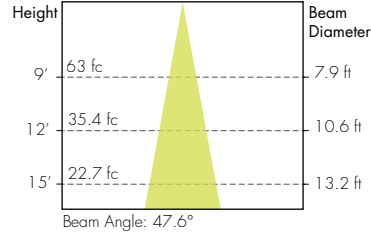

60° Faceted Reflector

