



LLX18X2-RGBW is a high performance flexible LED fixture suitable for use in coves, under cabinets, in shelves, and virtually anywhere a linear fixture is required.



ROHS

Environment
Dry Location

Lumen Maintenance
50,000 Hours

Operating Voltage
24 VDC

Warranty
5 Years

Standard Colors/Color Temperatures: RGBW and RGBA.
LLX18X2-RGBW is dimmable via DMX.

Technical information

Electrical

Input Voltage	24VDC
Power Consumption	8.8 Watts per foot (36 LEDs per foot)
Wire Size	18AWG, 5 wire
Certification	ETL - Conforms to UL Std. 2108; Certified to CSA Std. C22.2 No. 9.0 Class 2

Lumen Output

RGB+3000K	438 lm/ft 58.53 lm/watt
RGB+Amber	238 lm/ft 27 lm/watt

Note: Stated lumen values have a tolerance of +/- 10%.

Physical

Field Cuttable	3.94" (100.00mm)
Pitch length	0.66"
Operating Temperature	-40°F (-40° C) to +158°F (+70°C)
Environment	Dry Location
Maximum Run Length	10.00' (3048.00mm)
Dimensions	0.79" (20.00mm) x 0.10" (2.65mm)

Performance

CCT	3000K, Red, Green, Blue, White/Amber
CRI	90+ (White)
Lumen Maintenance	50,000 Hours
Binning Tolerance	+/- 100K
Warranty	5 years

Ordering Code

MODEL	COLOR	SECTION START	SECTION END	LENGTH
LLX18X2-RGBW	30K	F	NC	
LLX18X2-RGBW	30K - RGB with 3000K	F - Female connector M - Male connector SL - Soldered lead wires (72") NC - No connector	F - Female connector M - Male connector SL - Soldered lead wires (72") NC - No connector	View specs above for increment options and maximum run limits.

Dimensions

Optic Arts® cuts all LLX18X2-RGBW to length per customer specifications. Each length of LLX18X2-RGBW is fitted with a 6' (1.8M) wire lead (custom lengths available upon request) and packaged on a reel in an anti-static bag. Bags are labeled with fixture type, length and location (if applicable). Each piece of channel is labeled with fixture type, length and location (if applicable), and is bundled by fixture type.

- Due to the nature of the LLX18X2-RGBW product, specific lengths may not fall exactly on a cutting point. In this case, Optic Arts® will always cut to the smaller dimension unless otherwise specified.
- Some on-site assembly required. See installation guides for details.

LLX18X2-RGBW

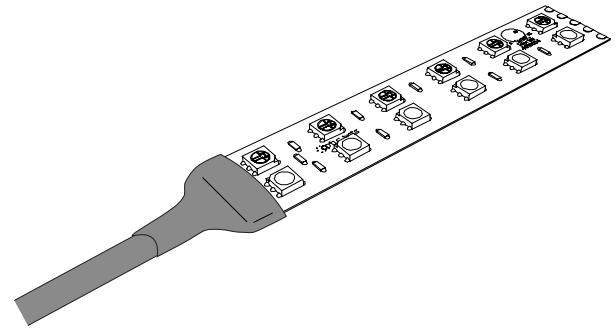
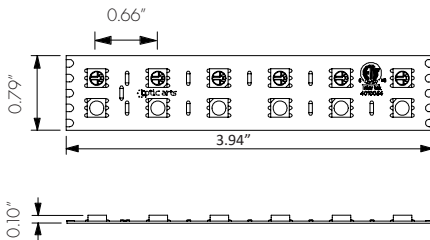

Dimensions

Width	0.79" (20.00mm)
Height	0.10" (2.65mm)
Cuttable Segment Length	3.94" (100.00mm)
Pitch Length	0.66" (16.82mm)
Max Run Length	10.00' (3048.00mm)

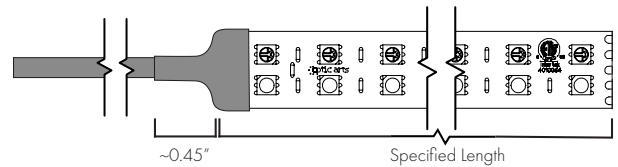

Lens options

C Clear

F Frosted

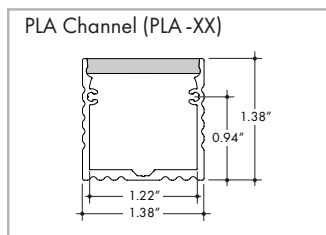

C F

Accessories

LC-I5P-M

Indoor Lead Connector (Male)

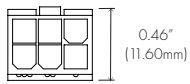
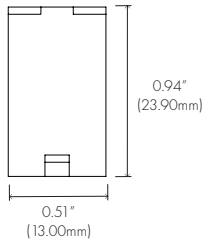
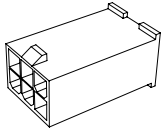

LC-I5P-F

Indoor Lead Connector (Female)

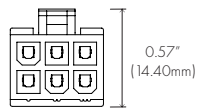
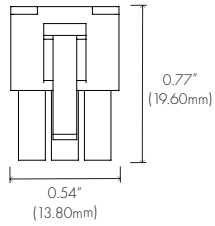
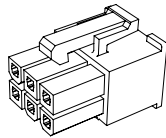

LL.ZIP

Strain Relief Clip

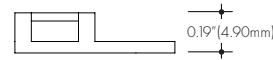
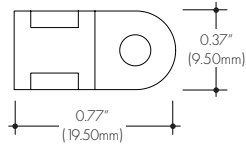
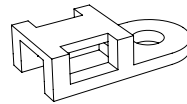

LO-18G-5C-W-72

6' (1.8M) wire lead (not in-wall rated)

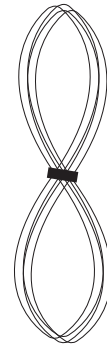

Power Supplies

See fixture and power supply instructions & spec sheet for wiring information. Dimming possible in select models - view Luminii website for list of compatible dimmers.

DMX Dimming Power Supplies 120VAC - 277VAC

MODEL	POWER	OUTPUT
PSDMX - DMX Power Supply dims down to 0%	96 - 96 Watt 3X96 - 3 X 96 Watt	24 - 24 VDC

Features eldoLED's LINEARdrive configurable dimmable drivers
*With controller only

MODEL	96W	3X96
Length	14.40"	13.00"
Width	5.20"	6.62"
Depth	2.60"	4.20"

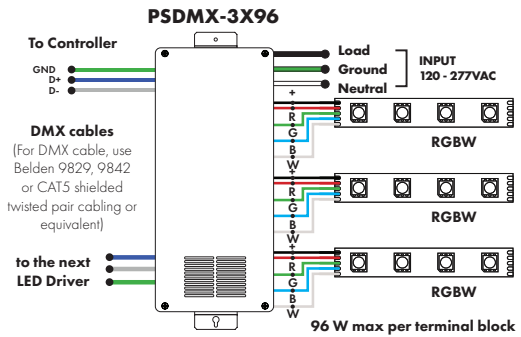
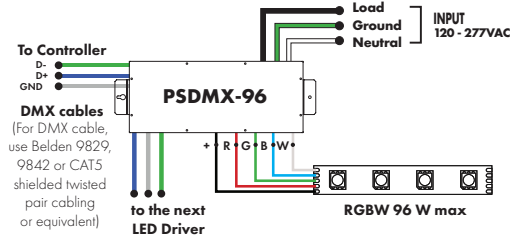

Non-Dimming Power Supply 120VAC - 277VAC

MODEL	POWER	OUTPUT	DIMMING	LOCATION
PSV - PSV Series	96 - 96 Watt	24 - 24 VDC	ND - Non Dimming	D - Dry location

Requires a controller and a decoder to work properly

MODELS	96W
Length	8.25"
Width	3.75"
Depth	1.63"

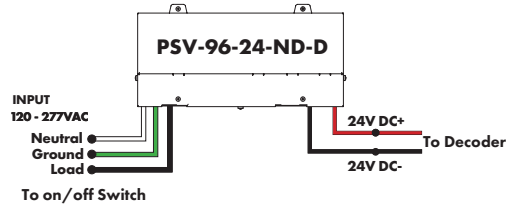

Decoders



DMX512 decoder with RDM functionality features 5 PWM output channels with common anode. High PWM output frequency range allows the product to be used in HD video conferencing spaces. All DMX products to be installed per DMX512 Standard.

Power
96 Watt

Inputs
RJ45, XLR-5Pin, Terminal Block

DMX Channels
1 to 5 settable

PWM Output Resolution Ratio
8 or 16 bit

PWM Output Frequency
500Hz - 30KHz

Output Dimming Curve Gamma Value
0.1 ~ 9.9

MODEL

DDMX-5CH-RDM-PRO

DDMX-5CH-RDM-PRO-DMX512 Decoder

Decoders



MODEL

DDMX-RGBW

DDMX-RGBW - DMX512 Decoder

Translates controller DMX512 programs for RGB and white LED strips.

Unique DMX address for the decoder can be set easily and displayed by the numeric display on the case. Changing and resetting the DMX address requires manual input.

Use power repeater to expand output (Luminii part# RGBW-SR).

Operating Voltage
12-36 VDC

Power Capacity
up to 96W at 24V

Operating Temperature Range
from -4°F to +122°F in case

PWM Output Frequency
200Hz or 1500Hz



MODEL

RGBW-MC3

RGBW-MC3 - 4-zone RGBW controller

Easy to operate wireless interface suitable for static or color changing scenes. Control 4 different color zones separately or at the same time. RGBW receiver (RGBW-RC-R) required for operation. Assign multiple receivers per zone to cover a large area.

Color wheel enables highly stable and sensitive color control functionality. Create your own color changing sequences with ease and flexibility.

Power
qty 3 AAA batteries

Scenes
up to 4 unique zones

Signal
Wireless (RF)

Energy Saving
Deactivates after 10 seconds of inactivity

Color Parameters

- Brightness
- Saturation
- Primary colors
- Speed of color changing sequence
- Fading



MODEL

RGBW-RC-R

RGBW-RC-R - RGBW receiver

The RGBW receiver is easily paired with controller by the click of a button. Receiver can be reset to factory settings at any time.

Each receiver can store one static RGB color, one color sequence, and one brightness setting for the white LED strip. Receivers assigned to the same scene within the same zone will have the same LED static color and color sequence.

Operating Voltage
12-36 VDC

Power Capacity
up to 96W at 24V

Operating Temperature Range
from -4°F to +122°F in case

Decoders



MODEL

RGBW-SR

RGBW-SR - RGBW signal repeater

Extends identical signal when connected in series to an RGBW LED control system. The RGBW signal repeater works with Luminii RGB and RGBW controllers, receivers, and decoders.

RGBW signal can be extended indefinitely when adequate power supply (not included) is connected to the system.

Operating Voltage
12-36 VDC

Power Capacity
up to 96W at 24V

Operating Temperature Range
from -4°F to +122°F in case



MODEL

RGBW-WI-R

RGBW-WI-R - WIFI generator

RGBW-WI-R creates a local network that enables any electronic device (phone, tablet, etc.) to control the RGB/W strip connected to a RGBW-RC-R receiver.

The control functions are achieved through a free application download for Android and iOS devices called REALCOLOR.

Operating Voltage
12-36 VDC

Power Supply
PI-130-24 (included)

Operating Temperature Range
from -4°F to +122°F in case

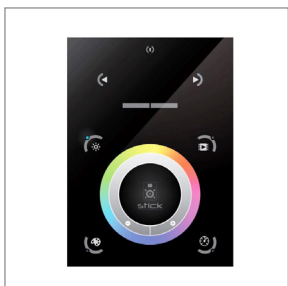

MODEL

TSDMX-E

TSDMX-E - Touchscreen DMX controller

Programmable advanced DMX512 lighting controller featuring a touch-screen interface. Operates as stand alone controller or integrated with most architectural lighting control systems. Can controller endless DMX512 enabled devices.

Mounts to standard single or dual gang wall box with the included power supply inside the junction box. Terminal block design for power and data connections.

Features

- Sleek glass design which sits 0.43" from the wall
- Graphical color display to show selected environment
- Color/dimmer/speed palette
- Color temperature mixing
- Touch sensitive buttons. No mechanical parts
- Touch sensitive wheel allows for accurate color selection
- Multi-zone microSD memory
- Multi-room control with 500 scenes, 10 zones
- 1024 DMX channels. Control 340 RGB fixtures
- USB & Ethernet connectivity for programming and control

Power Supply

7 VDC (included)

Programmability

PC, Mac, Tablet, Smartphone

Output Signal

DMX512 (1024 channels)

Color Parameters

- Brightness
- Saturation
- Speed of color changing sequence
- Fading / dimming / brightness

Decoders



DMX /Wireless RGB-W wall-mount controller controls DMX lighting fixtures, wireless control of RGB-W lighting fixture or use both simultaneously. Fits in any standard US switch box. Includes all the outputs in the back of the controller. Control brightness levels with a single touch, personalize and memorize 3 different scenes, and even create 3 variations of white.

Features

- 2 in 1 in-Wall Controller: DMX Control or Wireless RGB-W
- 65,000 Color Options, Dimming and Speed Control
- Memory Function
- 50 Foot Wireless Range
- Easily Fits Standard US Switch Boxes
- Touch Sensitive Glass Surface
- Includes 10 Built in Programs, or Create and Play Your Own

Operating Voltage

12 - 24V DC

Color Parameters

- Brightness
- Saturation
- Primary colors
- Fading
- Color changing speed

MODEL	ZONES	COLOR
DMX-DMX	3Z-3 Zone 1Z-1 Zone	RGBW-Red, Green, Blue, & White