

Features

LineLED Dynamic White series is a small profile high performance LED strip. This Dynamic White LED series offers a wide CCT range to create the perfect ambiance in real time. From bright white encouraging wakefulness, to warm amber sunsetting into relaxation, LineLED DW68 can transform any environment to match the natural human circadian rhythm. Industry-best color consistency with single-binned LEDs. This High Color Quality LED strip boasts CRIs and R9 values up to 97. It is easily installed within discrete aluminum extrusions with multiple mounting options.



Mounting

LED strip is equipped with 3M™ self-adhesive tape.

Applications

Indoor only - millwork, cove, architectural reveals, undercabinet, display case, handrail, accent lighting.

Operating voltage
24 VDC

Average Life (L70)
50,000 hours

Warranty
5 years

Approvals

Class 2 damp listed



Technical information

TYPE	LLDW68			
	SO (19K-35K)	SO (27K-65K)	HO (19K-35K)	HO (27K-65K)
OUTPUT OPTIONS				
Lumens Output (all channels full on)	332 lm/ft (29K)	422 lm/ft (44K)	391 lm/ft (29K)	507 lm/ft (44K)
Average Power Consumption (for a 4" section)	4.6 W/ft		5.6 W/ft	
Efficacy	72 lm/W	92 lm/W	70 lm/W	91 lm/W
Cutting Increment (in)	2.46"			
Pitch Length	0.18"			
Max Run Length (in series)	32 ft			
Dimensions	0.48"W x 0.09" H			

CCT	CRI	TM-30		
		R _f	R _g	R ₉
1900K	97	94	98	95
2700K	98	96	101	91
2900K	98	96	102	94
3500K	97	94	105	97
4400K	97	91	101	97
6500K	92	88	97	64

Section Start/End Options

SL

Soldered lead wires (72")

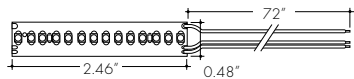

LF

Lead Female 3" cable

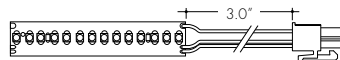

NC

No connector

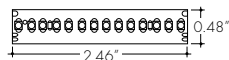

LM

Lead Male 3" cable

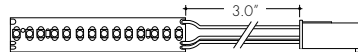

Ordering Code

MODEL	OUTPUT	CCT	SELECTION START	SELECTION END	LENGTH
LLDW68-LineLED DW68	SO-Standard HO-High	19K-35K-1900K - 3500K 27K-65K-2700K - 6500K	SL-Soldered lead wires (72") LF-Female Quick Connect LM-Male Quick Connect NC-No Connector	SL-Soldered lead wires (72") LF-Female Quick Connect LM-Male Quick Connect NC-No Connector	Ordered in one foot increments. See chart above for max run length.

Minii Connectors

Minii connectors are easy, field-installable accessories that make joining LL strip simple! Their minimal width allows them to fit into extrusions, while their transparent frame eliminates dark spots.
Note: verify internal extrusion dimensions to confirm compatibility

LL-PJC-12-03-DW

Jumper minii connector with 3" wire for LLDW68 strip

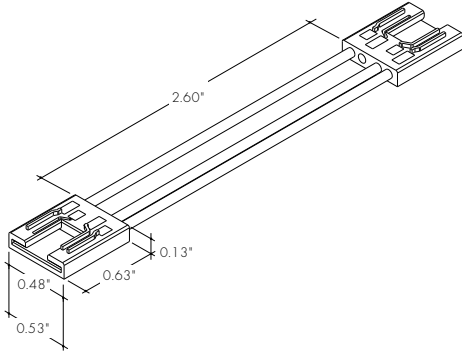

LL-PFC-12-72-DW

Power feed minii connector with 72" wire for LLDW68 strip

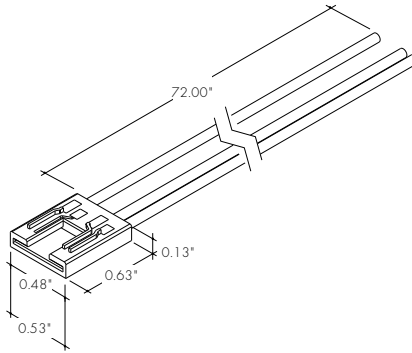

LL-BSC-12

Butt splice minii connector for LED strip

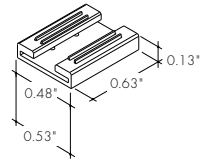

Sample Layout

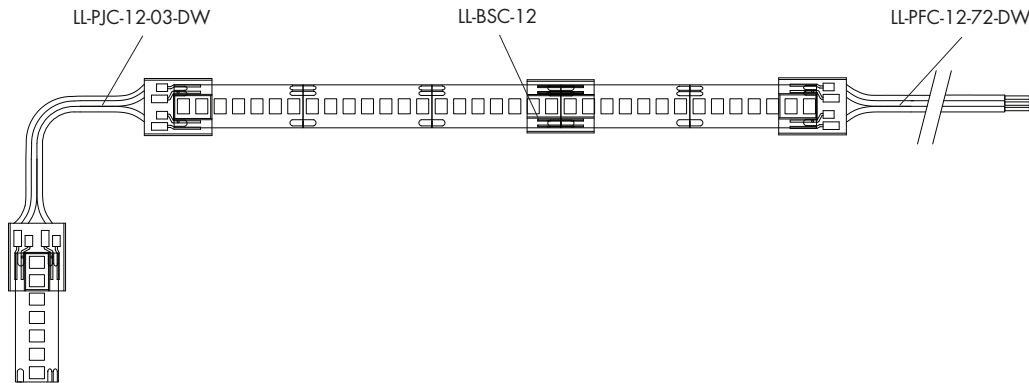

Accessories

CL2

Mounting Clip

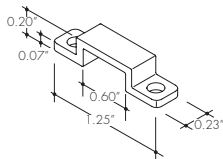

recommended at every 12" when LineLED strip is facing down.

LVSP-4T-BK

Splice Box

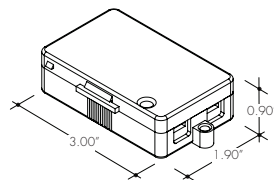

low voltage, 4 terminal splice box, black.

LL.ZIP

Cable/Wire Strain Relief Clip

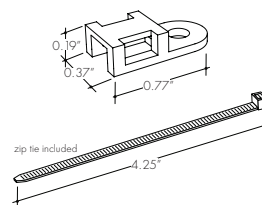

Lens Options / Light Transmission



Clear



Half (50%)
Frosted



Graze



Frosted



Flat
Frosted



Raised



Square
Frosted



Round Square
Frosted



13°
Semi-Frosted

*Not compatible with Minii connectors

*Not compatible with Minii connectors

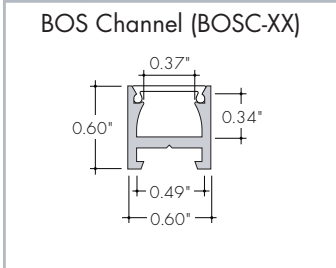

F **SI** **R** **G**
52% 66% 60% 76%

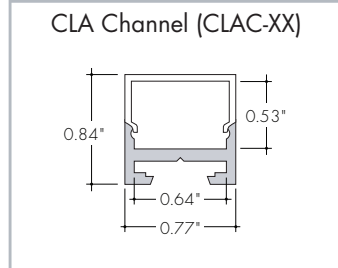

S **Q**
62% 65%

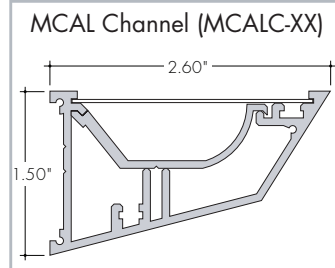

C
94%

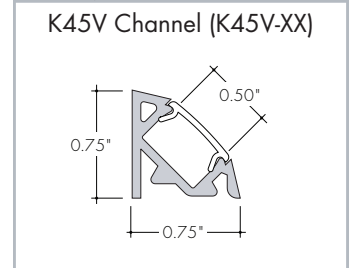

C **HF** **F** **13°**
82% 68% 45% 75%

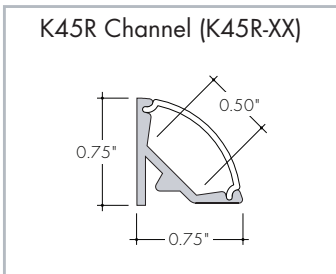

RF
61%

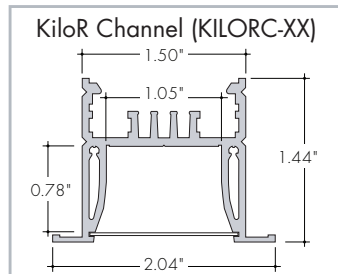

C **F**
85% 75%

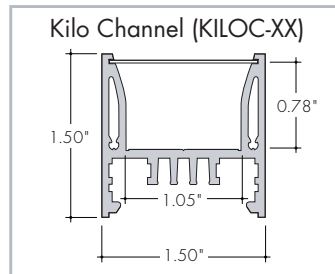

C **F**
85% 75%

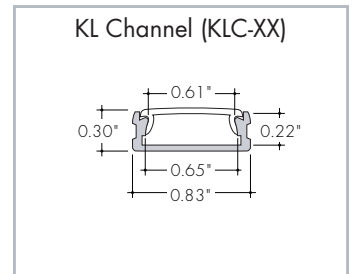

C **HF** **F**
81% 67% 51%

*Not compatible with Minii connectors

*Not compatible with Minii connectors

*Not compatible with Minii connectors

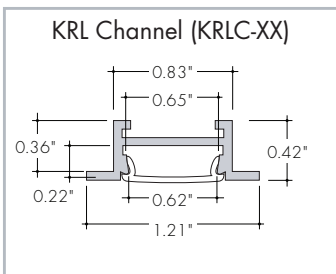

C **HF** **F**
81% 67% 51%

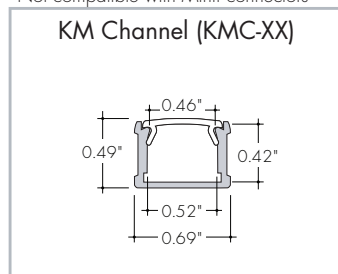

C **HF** **F** **FF** **R** **GR**
82% 68% 45% 52% 58% 56%

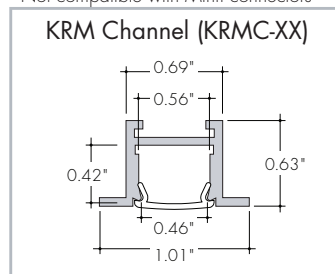

C **HF** **F** **FF** **GR**
82% 68% 45% 52% 56%

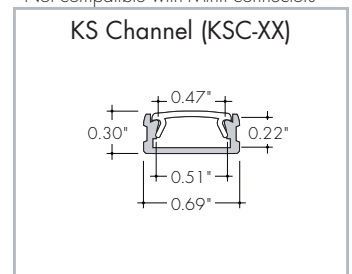

C **HF** **F** **FF** **R** **M**
86% 71% 56% 60% 85% 64%

Installation

All mounting channels are field cuttable using miter saw with circular blade suitable for cutting aluminum.

Ordering

Extrusions are sold separately. View respective specsheets for details on ordering extrusions and their accessories (endcaps, mounting brackets, etc).

Led Dotting per Extrusion

using the frosted lens option

Extrusion	LLDW68 (All On)	LLDW68 (1-Channel)
KSC, KRSC	ND	CD
KMC, KRMC, K45V	ND	ND
KXLC, KRXLC	ND	ND
KLC, KRLC	ND	CD
KILOC, KILORC	ND	ND
K45V	ND	SD
K45C	ND	ND
RO15	ND	ND
RO	ND	ND
BOSC	ND	SD
CLAC	ND	ND
MCAL	ND	ND

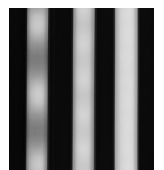

CD SD ND
CD - Clear Dotting
SD - Slight Dotting
ND - No Dotting

C
Clear

HF
Half (50%)
Frosted

GR
Graze

F
Frosted

FF
Flat
Frosted

R
Raised

S
Square
Frosted

Q
Round Square
Frosted

13°
13°
Semi-Frosted

*Not compatible with Minii connectors

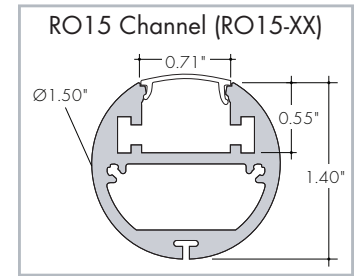
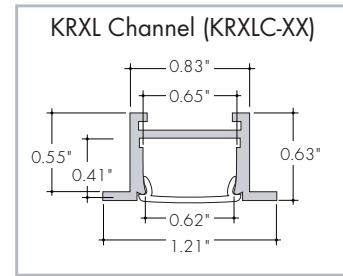
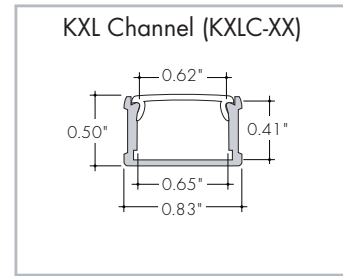
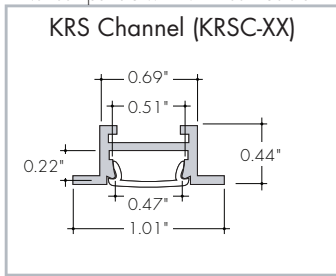

C 86%
HF 71%
F 56%
FF 60%
M 64%

C 81%
HF 67%
F 51%

C 81%
HF 67%
F 51%

C 65%
F 41%

*Not compatible with Minii connectors

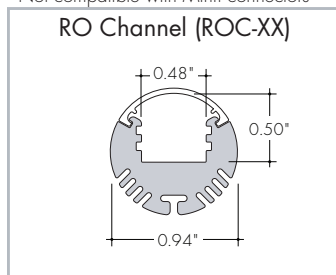

C 79%
F 50%

Installation

All mounting channels are field cuttable using miter saw with circular blade suitable for cutting aluminum.

Ordering

Extrusions are sold separately. View respective specsheets for details on ordering extrusions and their accessories (endcaps, mounting brackets, etc).

Led Dotting per Extrusion

using the frosted lens option

Extrusion	LLDW68 (All On)	LLDW68 (1-Channel)
KSC, KRSC	ND	CD
KMC, KRMC, K45V	ND	ND
KXLC, KRXLC	ND	ND
KLC, KRLC	ND	CD
KILOC, KILOC	ND	ND
RO15	ND	ND
BOSC	ND	SD
CLAC	ND	ND
MCAL	ND	ND

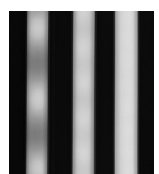

CD SD ND
CD - Clear Dotting
SD - Slight Dotting
ND - No Dotting

Power Consumption

Tested at full power with PDC Series power supplies.

Nominal Length	LLDW68-SO		LLDW68-HO	
	W/ft	Total Wattage	W/ft	Total Wattage
1	4.6	4.6	5.9	5.9
2	4.7	9.8	5.9	12.3
3	4.7	14.5	5.9	18.3
4	4.7	19.0	5.9	24.0
5	4.6	22.5	5.8	28.6
6	4.7	27.6	5.6	33.1
7	4.4	30.5	5.5	38.5
8	4.5	35.8	5.5	44.2
9	4.4	39.7	5.3	47.8
10	4.2	42.7	5.2	52.5
11	4.2	46.5	5.0	55.7
12	4.0	48.5	4.9	59.6
13	4.0	51.1	4.8	61.3
14	4.0	55.4	4.6	64.0
15	4.0	59.4	4.5	67.8
16	3.8	61.4	4.4	70.4
17	3.7	63.5	4.3	72.6
18	3.6	65.6	4.1	73.5
19	3.5	67.6	3.9	73.7
20	3.5	69.6	3.7	74.7
21	3.4	71.2	3.6	75.5
22	3.3	72.4	3.5	76.5
23	3.2	73.7	3.4	77.5
24	3.1	74.8	3.3	78.5
25	3.1	77.2	3.2	79.9
26	3.0	78.0	3.1	80.7
27	2.9	78.9	3.0	81.6
28	2.8	79.8	3.0	82.8
29	2.8	81.0	2.9	82.9
30	2.7	81.3	2.8	83.5
31	2.7	82.2	2.7	84.2
32	2.6	82.6	2.7	84.8

Voltage Drop Calculator

The below chart assumes nominal voltage of 24 Volts and a Voltage Drop Allowance of 3% through the wire

Wattage [W]	Maximum Wire Length From Power Supply to Start of Run [ft]						
	12 AWG	14 AWG	16 AWG	18 AWG	20 AWG	22 AWG	24 AWG
5	1088.2	684.4	430.3	270.6	170.2	107.1	67.3
10	544.1	342.2	215.1	135.3	85.1	53.5	33.7
15	362.7	228.1	143.4	90.2	56.7	35.7	22.4
20	272.0	171.1	107.6	67.7	42.6	26.8	16.8
25	217.6	136.9	86.1	54.1	34.0	21.4	13.5
30	181.4	114.1	71.7	45.1	28.4	17.8	11.2
35	155.5	97.8	61.5	38.7	24.3	15.3	9.6
40	136.0	85.5	53.8	33.8	21.3	13.4	8.4
45	120.9	76.0	47.8	30.1	18.9	11.9	7.5
50	108.8	68.4	43.0	27.1	17.0	10.7	6.7
55	98.9	62.2	39.1	24.6	15.5	9.7	6.1
60	90.7	57.0	35.9	22.6	14.2	8.9	5.6
65	83.7	52.6	33.1	20.8	13.1	8.2	5.2
70	77.7	48.9	30.7	19.3	12.2	7.6	4.8
75	72.5	45.6	28.7	18.0	11.3	7.1	4.5
80	68.0	42.8	26.9	16.9	10.6	6.7	4.2
85	64.0	40.3	25.3	15.9	10.0	6.3	4.0
90	60.5	38.0	23.9	15.0	9.5	5.9	3.7
96	56.7	35.6	22.4	14.1	8.9	5.6	3.5

Power Supplies

See fixture and power supply instructions & spec sheet for wiring information. Dimming possible in select models - view Luminii website for list of compatible dimmers.

DALI 0% Dimming Power Supplies 120VAC - 277VAC

MODEL	POWER	OUTPUT
PSDALI-DT8 - DALI-DT8 LED Driver	96 - 96 Watt	24 - 24 VDC

Features eldoLED's LINEARdrive configurable dimmable drivers

Model	96W
Length	14.40"
Width	5.20"
Depth	2.60"

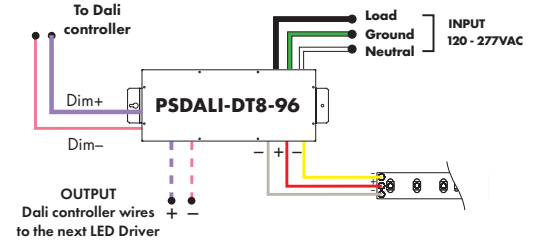

Customizable Dim to Warm or Variable White via 0 - 10V (for tunable white or warm dimming control of Dynamic option)

MODEL	POWER	OUTPUT	CONTROL
PSO10VD-0-10V Vintage Dim LED Driver	96-96 Watt 3X96 - 3 X 96 Watt	24-24 VDC	WW-Standard One Channel - Dim To Warm Curve W2C-Standard Two Channel - Dim 1: Intensity; Dim 2: CCT *W2I-Standard Two Channel - Dim 1: Warm Channel Intensity; Dim 2: Cool Channel Intensity *W1X-___Custom One Channel - Dim To Warm Curve *W2X-___Custom two Channel - Dim 1: Intensity; Dim 2: CCT

Requires a 0-10V controller to work properly
 *For 96 only, not available for 3X96.

MODELS	96W	3X96
Length	14.40"	13.00"
Width	5.20"	6.62"
Depth	2.60"	4.20"

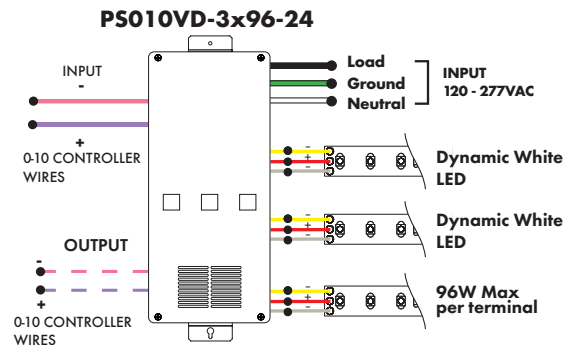
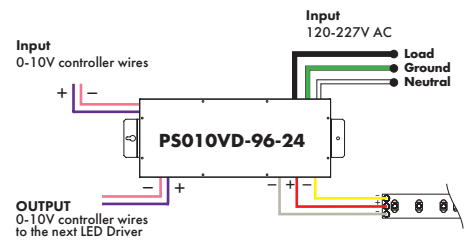

Non-Dimming Power Supply 120VAC - 277VAC

MODEL	POWER	OUTPUT	DIMMING	LOCATION
PSV - PSV Series	96 - 96 Watt	24 - 24 VDC	ND - Non Dimming	D - Dry location

Requires a controller and a decoder to work properly

Model	96W
Length	8.25"
Width	3.75"
Depth	1.63"

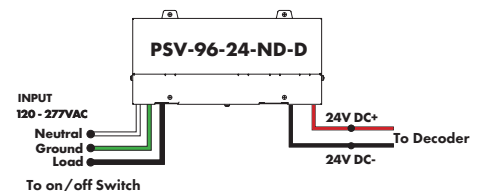

Power Supplies

See fixture and power supply instructions & spec sheet for wiring information. Dimming possible in select models - view Luminii website for list of compatible dimmers.

DMX 0% Dimming Power Supplies 120VAC - 277VAC

MODEL	POWER	OUTPUT
PSDMX-DMX Power Supply dims down to 0%	96 - 96 Watt 3X96 - 3 X 96 Watt	24-24 VDC

Features eldoLED's LINEARdrive configurable dimmable drivers.

DDMX-RGBW DMX Decoder not required when purchasing this power supply.

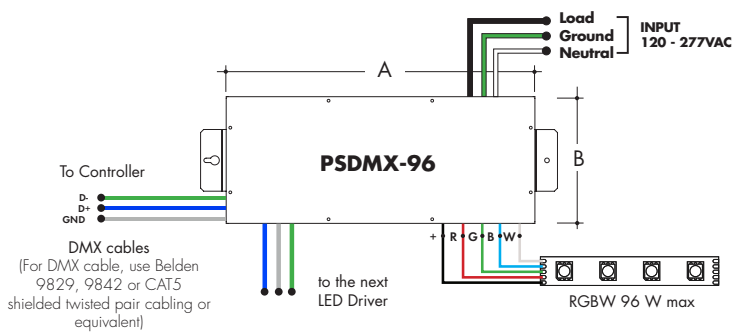

MODELS	96W	3X96
A Length	14.40"	15.75"
B Width	5.20"	6.62"
Depth	2.60"	4.95"

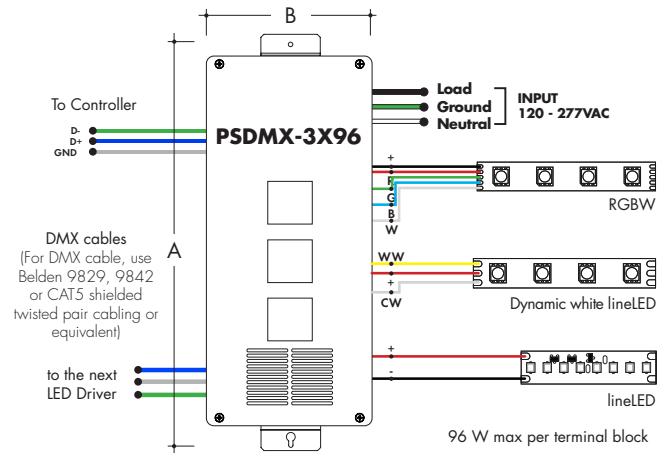

Decoders



MODEL

DDMX-5CH-RDM-PRO

DDMX-5CH-RDM-PRO-DMX512 Decoder

DMX512 decoder with RDM functionality features 5 PWM output channels with common anode. High PWM output frequency range allows the product to be used in HD video conferencing spaces. All DMX products to be installed per DMX512 Standard.

Power
96 Watt

Inputs
RJ45, XLR-5Pin, Terminal Block

DMX Channels
1 to 5 settable

PWM Output Resolution Ratio
8 or 16 bit

PWM Output Frequency
500Hz - 30KHz

Output Dimming Curve Gamma Value
0.1 ~ 9.9



MODEL

DDMX-RGBW

DDMX-RGBW - DMX512 Decoder

Translates controller DMX512 programs for RGB and white LED strips.

Unique DMX address for the decoder can be set easily and displayed by the numeric display on the case. Changing and resetting the DMX address requires manual input.

Use power repeater to expand output (Luminii part# RGBW-SR).

Operating Voltage
12-36 VDC

Power Capacity
up to 96W at 24V

Operating Temperature Range
from -4°F to +122°F in case

PWM Output Frequency
200Hz or 1500Hz

Decoders



MODEL

DDW-MC

DDW-MC - Dynamic white controller

Dynamic white wall-mount controller controls lighting fixtures, wireless control of DW lighting fixture. Fits in any standard US switch box. Includes all the outputs in the back of the controller.

Features

- Switch & dimming control function, control range > 20M.
- Smooth transition between light levels.
- Separately operate dimming and color temperature functions.
- Able to control 1 zone with endless receivers. Each receiver can maximally be controlled by 8 remotes.
- Power, temperature color and dimming functions operated by push button after receivers are connected.

Operating Voltage

3V DC battery

Color Parameters

- Brightness
- Saturation
- Fading



MODEL

DW-DMX

DW-DMX - DMX controller

Dynamic white DMX wall-mount controller is a fully touch sensitive controller designed in accordance with standard protocol DMX512. Offers fast and accurate color temperature adjustment and brightness dimming of natural white, warm white and cold white. Designed with a touch color wheel, the DMX512 controller can adjust color temperature and brightness for all white LEDs smoothly and accurately. The DMX controller can control 1 zone with endless decoders.

Features

- 1 zone
- 6 color scenes
- DMX Control
- Touch Sensitive Glass Surface
- Dimming and Speed Control
- Memory Function
- Easily Fits Standard US Switch Boxes

Operating Voltage

12 - 24V DC

Color Parameters

- Brightness
- Saturation
- Primary colors
- Fading
- Color changing speed



MODEL

RGBW-RC-R

RGBW-RC-R - RGBW receiver

The RGBW receiver is easily paired with controller by the click of a button. Receiver can be reset to factory settings at any time.

Each receiver can store one static RGB color, one color sequence, and one brightness setting for the white LED strip. Receivers assigned to the same scene within the same zone will have the same LED static color and color sequence.

Operating Voltage
12-36 VDC

Power Capacity
up to 96W at 24V

Operating Temperature Range
from -4°F to +122°F in case

Decoders



MODEL

RGBW-SR

RGBW-SR - RGBW signal repeater

Extends identical signal when connected in series to an RGBW LED control system. The RGBW signal repeater works with Luminii RGB and RGBW controllers, receivers, and decoders.

RGBW signal can be extended indefinitely when adequate power supply (not included) is connected to the system.

Operating Voltage
12-36 VDC

Power Capacity
up to 96W at 24V

Operating Temperature Range
from -4°F to +122°F in case



MODEL

RGBW-WI-R

RGBW-WI-R - WiFi generator

RGBW-WI-R creates a local network that enables any electronic device (phone, tablet, etc.) to control the RGB/W strip connected to a RGBW-RC-R receiver.

The control functions are achieved through a free application download for Android and iOS devices called REALCOLOR.

Operating Voltage
12-36 VDC

Power Supply
PI-130-24 (included)

Operating Temperature Range
from -4°F to +122°F in case



MODEL

DW-DMX

DW-DMX - DMX controller

The SLD DimTW is a constant voltage warm dimming LED dimming module. The unique dimming module accepts 0-10V control and mimics a smooth, incandescent dimming curve.

Features

- Flicker free 0-100% dimming
- High efficiency up to 97%
- High precision dimming ratio:>1:1000
- Fully isolated plastic housing
- Comply with EN55015 and FCC part 15 without additional input filter and capacitors
- compact size, high reliability
- 3 years warranty

Operating Voltage
8-48 VDC

Decoders



MODEL

TSDMX-E

TSDMX-E - Touchscreen DMX controller

Programmable advanced DMX512 lighting controller featuring a touch-screen interface. Operates as stand alone controller or integrated with most architectural lighting control systems. Can controller endless DMX512 enabled devices.

Mounts to standard single or dual gang wall box with the included power supply inside the junction box. Terminal block design for power and data connections.

Features

- Sleek glass design which sits 0.43" from the wall
- Graphical color display to show selected environment
- Color/dimmer/speed palette
- Color temperature mixing
- Touch sensitive buttons. No mechanical parts
- Touch sensitive wheel allows for accurate color selection
- Multi-zone microSD memory
- Multi-room control with 500 scenes, 10 zones
- 1024 DMX channels. Control 340 RGB fixtures
- USB & Ethernet connectivity for programming and control

Power Supply

7 VDC (included)

Programmability

PC, Mac, Tablet, Smartphone

Output Signal

DMX512 (1024 channels)

Color Parameters

- Brightness
- Saturation
- Speed of color changing sequence
- Fading / dimming / brightness