

LETO 44 Mini S

SURFACE MOUNT LED DOWNLIGHT



LETO 44 Mini S - Surface LED Light. Leto 44 Mini S is the surface mount version of the Leto 44 Mini P. Designed as an all purpose light, it's perfect for creating even light throughout your space without distracting from your design.

Ordering Code

Fixture	657								
	1	2	3	4	5	6	7	8	9
Driver					--	--			
	1	2	3	4	5	6			

Product Specifications

SAMPLE: Fixture **657 - S - A90 - 617 - 27 - 07 - 00 - 08 - 01** | Driver **STD - 120 - A90 - 07**

1 - Model	2 - Size	3 - CRI/LED	4 - Optic	5 - CCT	6 - Lumen
657 · Leto 44 Mini Surface Mount	S · Small (73mm) M · Medium (209mm) L · Large (346mm)	A90 · Accuracy (90 CRI) CT · Color Tuning ^{CT} (90 CRI) WD · Warm Dimming ^{WD} (90 CRI)	617 · 17° 624 · 24° 660 · 60°	25 · 2500K 27 · 2700K 30 · 3000K ^{WD} 35 · 3500K 40 · 4000K 65 · 6500K 2765 · 2700K - 6500K ^{CT}	07 · 700 (6W) ^{WD} 10 · 1000 (9W) ^{WD} 13 · 1300 (16W) ^{†1/CT}
7 - Accessory	8 - Body Color	9 - Baffle Color	1 - Canopy Style	2 - Canopy Color	
00 · No Accessory DL · Diffusing Film HO · Honeycomb ^{†1}	<i>Standard</i> 01 · White 02 · Black 08 · Silver <i>Premium</i> 52 · Mocha 53 · Charcoal 54 · Cerulean 55 · Firebrick BZ · Bronze WN · Warm Nickel AB · Aged Brass XX · RAL	<i>Standard</i> 01 · White 02 · Black 08 · Silver <i>Premium</i> 52 · Mocha 53 · Charcoal 54 · Cerulean 55 · Firebrick BZ · Bronze WN · Warm Nickel AB · Aged Brass XX · RAL	955 · Round Slim ² 965 · Square Slim ² 954 · Round Semi-Recessed	<i>Standard</i> 01 · White 02 · Black 08 · Silver <i>Premium</i> 52 · Mocha 53 · Charcoal 54 · Cerulean 55 · Firebrick BZ · Bronze WN · Warm Nickel AB · Aged Brass XX · RAL	
3 - Driver	Dim Level	Dim Level	4 - Voltage	5 - CRI/LED	6 - Lumen
STD · Non Dimming LCS · 0 - 10 Volt Protocol ^{CT} DIM · Phase ³ ELDOLC · EldoLED 0 - 10 Volt ⁴	N/A 1% 1% 0.1%	DALI · Dali Protocol ^{4/CT} LUTES · Hilume Ecodigital ⁴ LUT2W · 2 Wire for phase ^{3/4} CSMB · Casambi Wireless Control ^{6/CT}	0.1% 1% 1% 0.1%	120 · 120V 277 · 277V 347 · 347V ^{4/5}	Same as Fixture Same as Fixture

*1 not available with small size

*2 10mm stem required for Round Slim see page 2 Canopy section

*3 120V only

*4 remote mount

*5 not available with DALI or Lutron drivers

LETO 44 Mini S

SURFACE MOUNT LED DOWNLIGHT



Light Engine: A90 Accuracy

- Output:** up to 1500lm
- High Efficacy:** up to 110 lumen/Watt
- Color Options (CCT):** 2500K, 2700K, 3000K, 3500K, 4000K, 6500K
- Color Consistency:** Range within a 3-MacAdam Ellipse
- Color rendering (CRI):** 93+ CRI & 50+ R9 Value

Driver

- Dimming:** 1% dimming standard with 0.1% option
- Ripple:** Industry leading Low ripple
- Efficiency:** Power Factor >0.9
Efficiency over 85%
Class 2 output for safety

Light Engine: Warm Dimming

- Output:** 1300lm
- High Efficacy:** up to 98 lumen/Watt
- Color Temperature (CCT):** 3000K dimmed to 1800K
- Color Consistency:** Range within a 3-MacAdam Ellipse
- Color rendering (CRI):** 90 CRI

Driver

- Dimming:** 1% dimming standard with 0.1% option
Dimmer switch must be capable of dimming less than 5% (Lutron DIVA is recommended)
- Ripple:** Industry leading Low ripple
- Efficiency:** Power Factor >0.9
Efficiency over 85%
Class 2 output for safety
- Installation:** Small Footprint allows retrofit installations

Light Engine: Color Tuning

- Output:** up to 1300lm
- High Efficacy:** up to 95 lumen/Watt
- Color Temperature (CCT):** 2700K up to 6500K
- Color Consistency:** Range within a 3-MacAdam Ellipse
- Color rendering (CRI):** 90 CRI

Driver

- Dimming:** Dali and DMX
- Ripple:** Industry leading Low ripple
- Efficiency:** Power Factor >0.9
Efficiency over 85%
Class 2 output for safety
- Installation:** Small Footprint allows retrofit installations

Installation

- Pre-assembled for quick and easy installation
- Flush mount to ceiling for gapless appearance

Construction

- Machined aluminum construction
- High quality, scratch resistant powder coated finish in standard, premium or custom colors
- Made in Canada

Dimensions

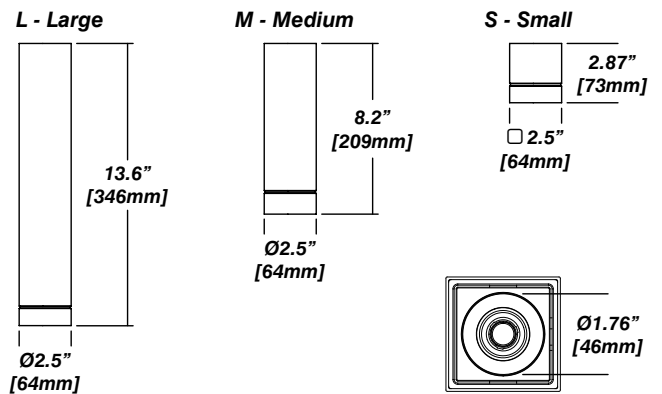

Driver Placement

- **Standard, LCS, and Phase dimming** drivers may be mounted in the junction box.
- Minimum volume required to mount drivers in junction box:
70mm x 40mm x 30mm

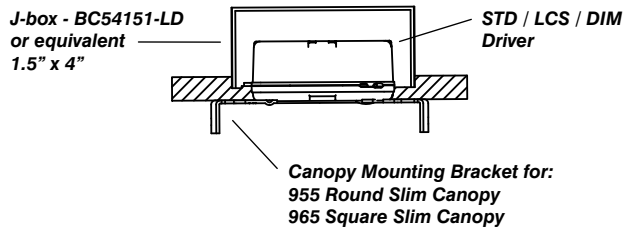

LETO 44 Mini S

SURFACE MOUNT LED DOWNLIGHT

Accessories

Diffusing Film

Honeycomb



Standard Finishes

01 - White

02 - Black

08 - Silver

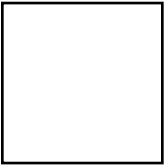

Premium Finishes

55 - Mocha

56 - Charcoal

57 - Cerulean



58 - Firebrick

BZ - Bronze

WN - Warm Nickle



AB - Aged Brass



Canopy

955 - Round Slim

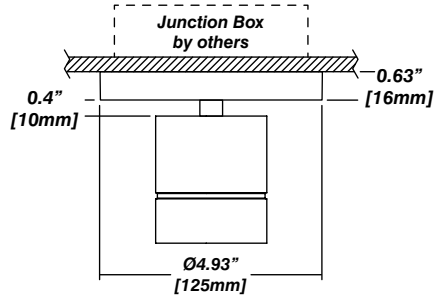

965 - Square Slim

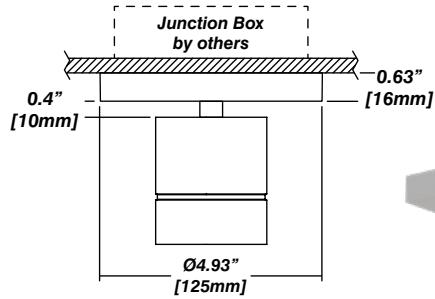

954 - Semi-Recessed + Cylinder Driver Housing

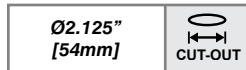
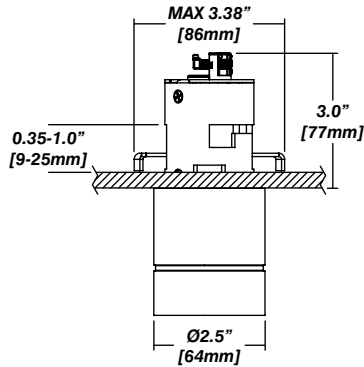

LETO 44 Mini S

SURFACE MOUNT LED DOWNLIGHT

Senso Driver Housings

910 - Single Remote Driver Housing

- Fits Standard, LCS or DIM drivers
- Galvanized steel enclosure
- Installed in remote location

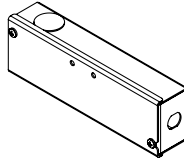

Dimensions

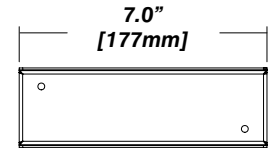
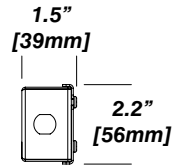

910 - Double Remote Driver Housing

- Fits all drivers
- Galvanized steel enclosure
- Installed in remote location

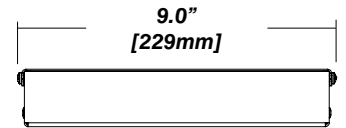
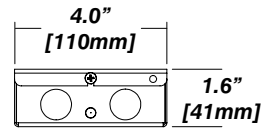
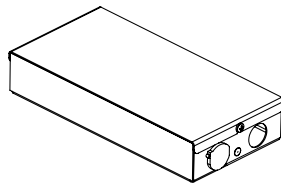

954 - Cylinder Driver Housing

- Supplied standard with every semi-recessed canopy
- Fits Standard, LCS or DIM drivers
- Extruded aluminum enclosure with strain relief to fixture
- Installed in ceiling beside canopy

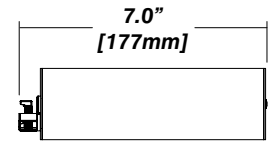
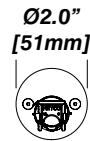
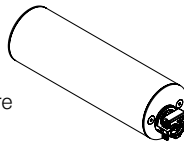

954 Driver Layouts

954 with Cylinder Driver Housing

- Installed in ceiling beside canopy
- Driver mounted inside cylinder
- Dimming control wired from Cylinder Driver Housing

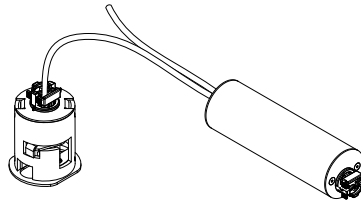

954 with 910 Single Driver Housing

- Driver remotely mounted inside 910 housing
- Fed to 910 housing
- WAGO connector for DC side
- Thermal protector for high temperatures

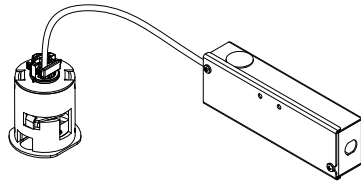

954 with 910 Double Driver Housing

- Driver remotely mounted inside 910 housing
- Fed to 910 housing
- WAGO connector for DC side
- Thermal protector for high temperatures

