

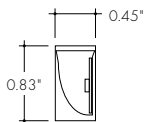

# Kurma Medium Horizontal Dynamic Color

Field Bendable 24V System

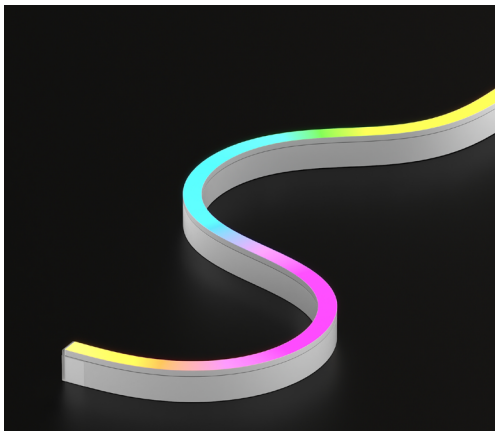

## Features

Kurma Medium is a dot free direct view, narrow profile, energy efficient and flexible LED strip suitable for outdoor wet locations capable of horizontal/side bends with a 2.5" bending radius. The silicone material offers excellent heat, weather, UV, and solvent resistance and has a special coating to repel dust and dirt accumulation.

### Output Options

- 2-Wire Warm Dim gradually warms the color temperature as you dim down the brightness.
- Tunable White allows individual control of CCT and output
- RGB options offer balanced output across the color gamut and a true white with RGBW
- Smart Pixel offerings allow for infinite color combinations with cascading and chasing effects

### Average Life (L70)

50,000 hours

### Approvals

24VDC Class 2 wet listed, IP68

### Warranty

3 years

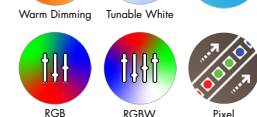

### Finish Options (see page 2 for additional information)

**Base**  White

**Premium**  Black  Red  Green  Blue

## Technical Information

Bending Direction	Horizontal				
Output	WD44SO	TW44SO	RGB18SO	RGBW18SO	SPI17SO
Light Output at 3000K	120 lm/ft	114 lm/ft	59 lm/ft	119 lm/ft	113 lm/ft
Average Power Consumption at 4'	3.66 W/ft	3.66 W/ft	3.66 W/ft	4.57 W/ft	4.57 W/ft
Efficacy	33 lm/W	31 lm/W	16 lm/W	26 lm/W	25 lm/W
Ordering Increment	3.28"	3.28"	3.94"	3.94"	4.92"
Maximum Run Length (In Series)	26'	26'	26'	19'	19'
Operating Temperature Range	-40°F to 131°F	-40°F to 131°F	-40°F to 131°F	-40°F to 113°F	-40°F to 113°F
Control/Dimming Protocol	Phase & 0-10V	0-10V, DMX	DMX	DMX	SPI Protocol UCS 2904

## Constraints

### Horizontal Bend Direction

Bend LED in these positions only to avoid damage

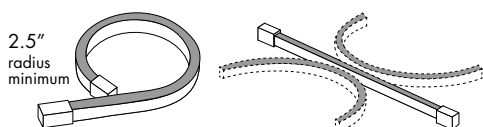

Illuminated surface shown in gray

### Horizontal Prohibited Bends

Twisting or bending LED in these positions will cause damage

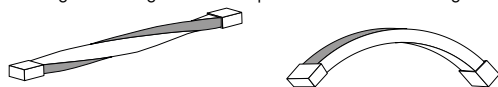

Illuminated surface shown in gray

Do not make sharp bends near the endcap

## Ordering Code

MODEL	RATING	BEND DIRECTION	LENGTH	OUTPUT	CCT	LENS <sup>3</sup>	MOUNTING	FINISH	FEED POSITION LEFT	FEED POSITION RIGHT
KBM - Kurba Medium	W - Wet	HB - Horizontal Bending	SEE PCC CHART ON PAGES 5 - 9	WD44SO - Warm Dim, Standard Output	18K30K - 1800K-3000K	SF - Silicone Frosted BL - Black Lens <sup>3</sup>	NA - See Page 4 for orderable mounting accessories	WH - White BK - Black RED - Red GRN - Green BLU - Blue	INJECTION MOLD	INJECTION MOLD
				TW44SO - Tunable White, Standard Output	22K57K - 2200K-5700K 26K42K - 2600K-4200K <sup>1</sup>				IME - End Feed 1 IMB - Back Feed 1 IMSA - Side 1 Feed NPF - No Power Feed <sup>4</sup>	IME - End Feed 1 IMB - Back Feed 1 IMSA - Side 1 Feed NPF - No Power Feed <sup>4</sup>
				RGB18SO - RGB, Standard Output	RGB - Red, Green, Blue					
				RGBW18SO - RGBW, Standard Output SPI17SO - Smart Pixel Control, Standard Output	RGB26K - RGB 2600K <sup>2</sup> RGB27K - RGB 2700K RGB30K - RGB 3000K RGB40K - RGB 4000K					

Feeds come with 90" wire leads

1 - TW44SO-26K42K option is only available with BL Lens Option

2 - RGBW18SO-RGB26K and SPI17SO-RGB26K option is only available with BL Lens Option

3 - BL - Black Lens can only be used with BK - Black Finish

4 - NPF-NPF for Feed Position 1&2 is not a valid configuration option



### Powerfeeds and Connectors

#### Power Feed Position Options and Orientation

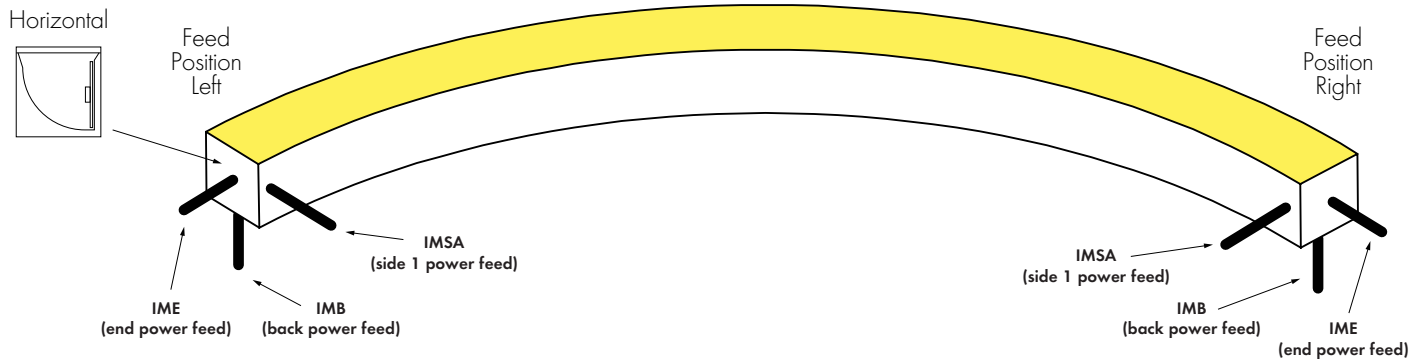

NOTE: IMSB - Side 2 Feed not available with HB - Horizontal Bending

#### Linking and Extension Cable Options

##### END CONNECTOR

Injection-molded End Connector  
-IME

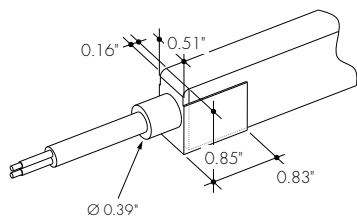

##### BACK CONNECTOR

Injection-molded Back Connector  
-IMB

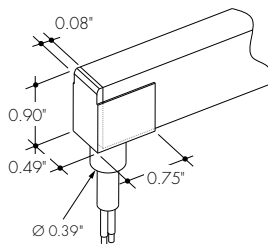

##### SIDE CONNECTOR

Injection-molded Side Connector  
-IMS

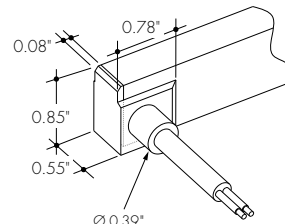

##### ENDCAP (NO CONNECTOR)

Injection-molded Cap (No Connector)  
-NPF

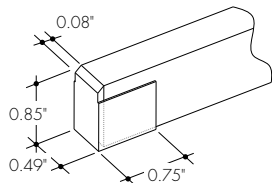

##### ANTI-WICKING FERRULE

Included on every power feed wire

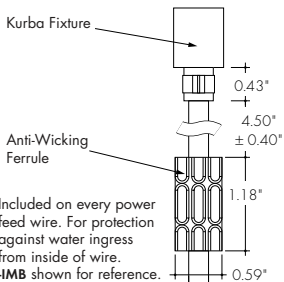

Included on every power feed wire. For protection against water ingress from inside of wire.  
-IMB shown for reference.



### Product Dimensions

Kurba Medium Cross Sections

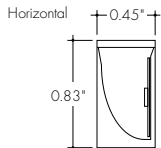

**Example Feed Position**  
**IME - NPF**  
End Feed 1 to  
No Power Feed

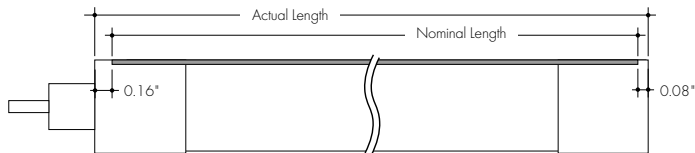
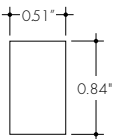

**Example Feed Position**  
**IMSA - NPF**  
Side 1 Feed to  
No Power Feed

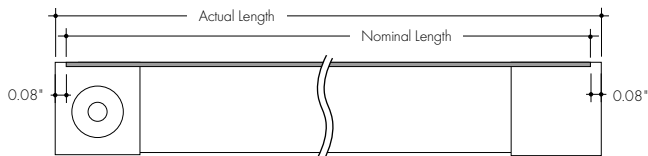
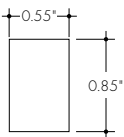

**Example Feed Position**  
**IMB - NPF**  
Back Feed 1 to  
No Power Feed

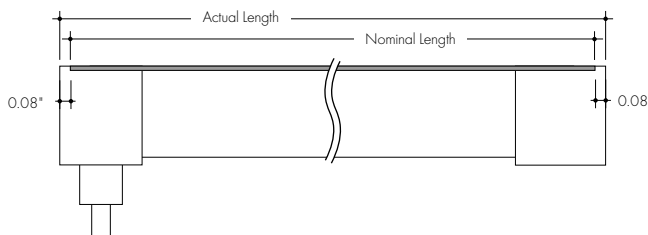
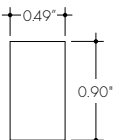

**Example Feed Position**  
**IME - IME**  
End Feed 1 and  
End Feed 1

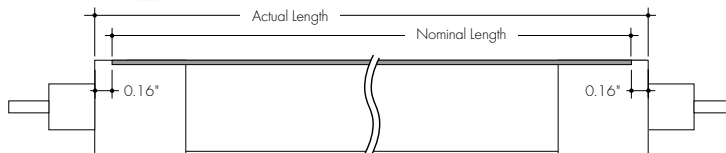
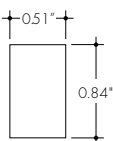

### Finish Options

- A wide variety of finish options allowing complete customization of style and aesthetic.

**White**  
*Base*

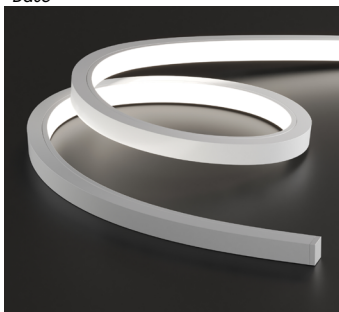

Kurba's base finish is a crisp white which brings a timeless, clean aesthetic that brightens and enhances any space

**Black Finish w/ Black Lens**  
*Premium*



Also available with a blackout aesthetic - the Black Lens paired with the Black Finish provides for a sleek, all black profile that keeps the strip concealed in the off-state.

**Red**  
*Premium*

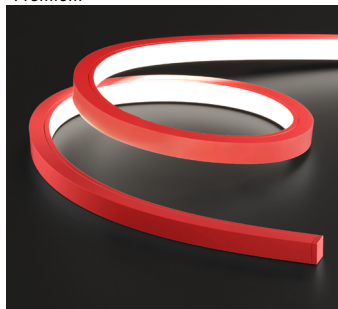

Red adds a bright and bold statement, perfect for creating a striking and dynamic ambience with its vibrancy

**Green**  
*Premium*

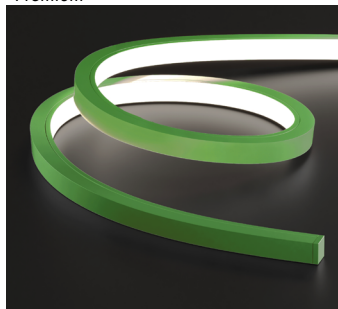

Green embraces a refreshing and natural feel, reminiscent of emerald green, add touch of tranquility and harmony to your space with this option

**Blue**  
*Premium*

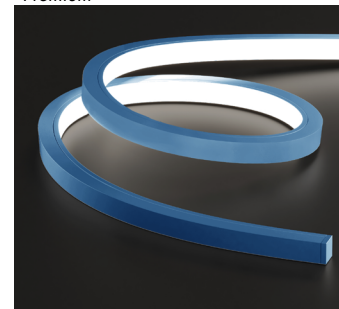

Blue evokes the serenity of the deep sea by combining vivid cobalt and azure tones.



### Light Transmission and Dotting

Output Options	Lens/Accessory					
	Silicone Frosted/ White Finish	Silicone Frosted/ Red Finish	Silicone Frosted/ Green Finish	Silicone Frosted/ Blue Finish	Silicone Frosted/ Black Finish	Black Lens/ Black Finish
WD44SO	ND	ND	ND	ND	ND	ND
TW44SO	ND	ND	ND	ND	ND	ND
RGB18SO	ND	ND	ND	ND	ND	ND
RGBW18SO	ND	ND	ND	ND	ND	ND
SPI17SO	ND	ND	ND	ND	ND	ND
<b>Transmission Percentage</b>	100%	80%	80%	80%	80%	17%



**CD** - Clear Dotting  
**SD** - Slight Dotting  
**ND** - No Dotting

### Mounting Accessories & Optional Connectors

#### MC-KBM-SAP-SM-0.8-SA

KBM Mounting Channel, Serrated Aluminum Profile, Surface Mount, 0.8in, Silver Anodized

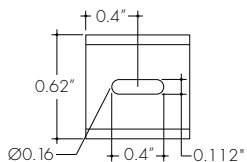
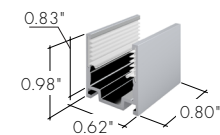

For use with light strip mounted to the ceiling.  
1 recommended every 8 in.

#### MC-KBM-SAP-SM-78-SA

KBM Mounting Channel, Serrated Aluminum Profile, Surface Mount, 78in, Silver Anodized

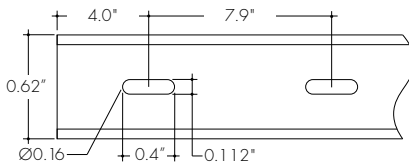
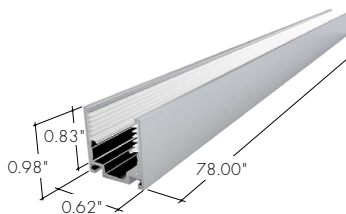

For use with light strip mounted to the ceiling.

#### MC-KBM-FSAP-TR-78-SA

KBM Mounting Channel, Flanged Serrated Aluminum Profile, Trimmed Recessed Mount, 78in, Silver Anodized

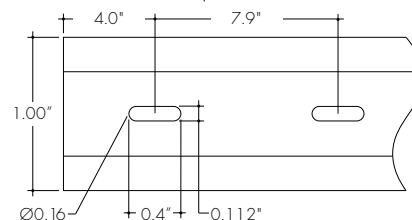
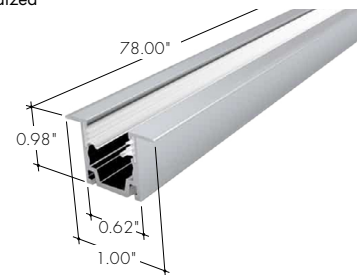

Flanged aluminum mounting channel providing grip.  
For use with light strip recessed into the ceiling.

#### MC-KBM-BSAP-HB-SM-38-SA

KBM Mounting Channel, Bendable Serrated Aluminum Profile, Horizontal Bending, Surface Mount, 38in, Silver Anodized

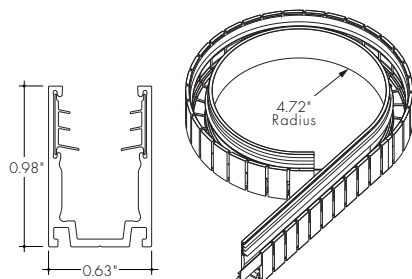

Bendable stainless steel mounting channel providing grip.  
For use with light strip mounted to the ceiling.  
**NOTE:** Compatible with **IMB** - Back Feed only

#### MC-KBM-RCWY-SM-78-SA

KBM Mounting Channel, Raceway, Surface Mount, 78in, Silver Anodized

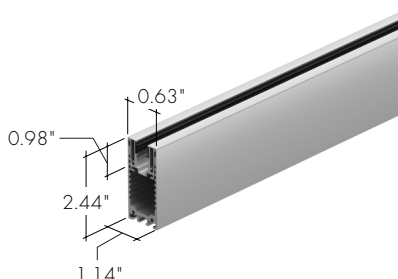

Raceway channel allows for hidden cable management and is a superb option where fineness is required.  
**NOTE:** Compatible with **IMB** - Back Feed only

#### LVSP-WET

Splice box: wet rated, low voltage, gray

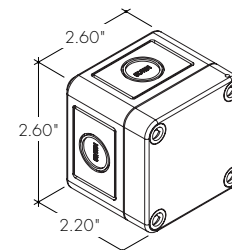

#### LVSP-WET-CM

Connector for splice box, low voltage for cable management, gray

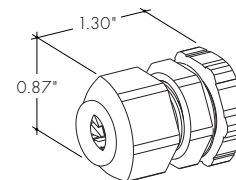



# Kurba Medium Horizontal Dynamic Color | Field Bendable 24V System



## WD44SO | Power Consumption Per Fixture Length

Based on operation with PDCU series of power supplies. Use Actual Length for Order Code Entry.  
 Tolerance for Actual Lengths less than 6 ft is +/- 0.2", Actual Lengths between 6 ft and 16 ft is +/- 0.3", and Actual Lengths greater than 16 ft is +/- 0.6"  
 A - End Connector at both ends of Kurba (0.16" + 0.16" added to overall length)  
 B - End Connector at one end of Kurba and No Connector or Back Connector or Side Connector at other end of Kurba (0.16" + 0.08" added to overall length)  
 C - Any combination of No Connector, Back Connector, or Side Connector on each end of Kurba (0.08" + 0.08" added to overall length)

Nominal Length (in)	Actual Length (in)				Nominal Length (in)	Actual Length (in)				Nominal Length (in)	Actual Length (in)			
	W	A	B	C		W	A	B	C		W	A	B	C
7	2.1	6.9	6.8	6.7	125	38.1	125.0	124.9	124.8	243	74.1	243.1	243.0	242.9
10	3.1	10.2	10.1	10.0	128	39.1	128.3	128.2	128.1	246	75.1	246.4	246.3	246.2
(1 ft) 14	4.1	13.4	13.4	13.3	(11 ft) 132	40.1	131.5	131.5	131.4	250	76.1	249.7	249.6	249.5
17	5.1	16.7	16.6	16.6	135	41.1	134.8	134.7	134.7	(21 ft) 253	77.1	252.9	252.9	252.8
20	6.1	20.0	19.9	19.8	138	42.1	138.1	138.0	137.9	256	78.1	256.2	256.1	256.1
(2 ft) 23	7.1	23.3	23.2	23.1	141	43.1	141.4	141.3	141.2	260	79.1	259.5	259.4	259.3
27	8.1	26.6	26.5	26.4	(12 ft) 145	44.1	144.7	144.6	144.5	(22 ft) 263	80.1	262.8	262.7	262.6
30	9.1	29.8	29.8	29.7	148	45.1	148.0	147.9	147.8	266	81.1	266.1	266.0	265.9
33	10.1	33.1	33.0	33.0	151	46.1	151.2	151.2	151.1	269	82.1	269.3	269.3	269.2
(3 ft) 36	11.1	36.4	36.3	36.2	(13 ft) 155	47.1	154.5	154.4	154.4	273	83.1	272.6	272.5	272.5
40	12.1	39.7	39.6	39.5	158	48.1	157.8	157.7	157.6	(23 ft) 276	84.1	275.9	275.8	275.7
43	13.1	43.0	42.9	42.8	161	49.1	161.1	161.0	160.9	279	85.1	279.2	279.1	279.0
46	14.1	46.2	46.2	46.1	164	50.1	164.4	164.3	164.2	283	86.1	282.5	282.4	282.3
(4 ft) 50	15.1	49.5	49.5	49.4	(14 ft) 168	51.1	167.6	167.6	167.5	286	87.1	285.7	285.7	285.6
53	16.1	52.8	52.7	52.7	171	52.1	170.9	170.8	170.8	(24 ft) 289	88.1	289.0	288.9	288.9
56	17.1	56.1	56.0	55.9	174	53.1	174.2	174.1	174.0	292	89.1	292.3	292.2	292.1
(5 ft) 59	18.1	59.4	59.3	59.2	178	54.1	177.5	177.4	177.3	296	90.1	295.6	295.5	295.4
63	19.1	62.7	62.6	62.5	(15 ft) 181	55.1	180.8	180.7	180.6	(25 ft) 299	91.1	298.9	298.8	298.7
66	20.1	65.9	65.9	65.8	184	56.1	184.0	184.0	183.9	302	92.1	302.1	302.1	302.0
69	21.1	69.2	69.1	69.1	187	57.1	187.3	187.2	187.2	306	93.1	305.4	305.3	305.3
(6 ft) 73	22.1	72.5	72.4	72.3	(16 ft) 191	58.1	190.6	190.5	190.4	309	94.1	308.7	308.6	308.5
76	23.1	75.8	75.7	75.6	194	59.1	193.9	193.8	193.7	(26 ft) 312	95.1	312.0	311.9	311.8
79	24.1	79.1	79.0	78.9	197	60.1	197.2	197.1	197.0					
(7 ft) 82	25.1	82.3	82.3	82.2	201	61.1	200.4	200.4	200.3					
86	26.1	85.6	85.5	85.5	(17 ft) 204	62.1	203.7	203.6	203.6					
89	27.1	88.9	88.8	88.7	207	63.1	207.0	206.9	206.8					
92	28.1	92.2	92.1	92.0	210	64.1	210.3	210.2	210.1					
(8 ft) 96	29.1	95.5	95.4	95.3	214	65.1	213.6	213.5	213.4					
99	30.1	98.7	98.7	98.6	(18 ft) 217	66.1	216.8	216.8	216.7					
102	31.1	102.0	101.9	101.9	220	67.1	220.1	220.0	220.0					
105	32.1	105.3	105.2	105.1	223	68.1	223.4	223.3	223.2					
(9 ft) 109	33.1	108.6	108.5	108.4	(19 ft) 227	69.1	226.7	226.6	226.5					
112	34.1	111.9	111.8	111.7	230	70.1	230.0	229.9	229.8					
115	35.1	115.1	115.1	115.0	233	71.1	233.3	233.2	233.1					
(10 ft) 119	36.1	118.4	118.3	118.3	237	72.1	236.5	236.5	236.4					
122	37.1	121.7	121.6	121.5	(20 ft) 240	73.1	239.8	239.7	239.7					

Note: all values are rounded to the nearest 0.1 inch

Endcap (No Connector) -NPF

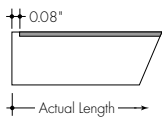

End Connector -IME

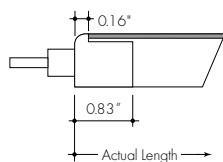

Back Connector -IMB

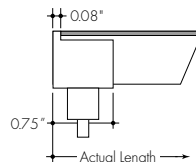

Side Connector -IMSA and -IMSB

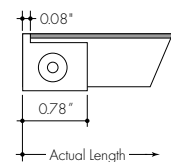



# Kurba Medium Horizontal Dynamic Color | Field Bendable 24V System



## TW44SO | Power Consumption Per Fixture Length

Based on operation with PDCU series of power supplies. Use Actual Length for Order Code Entry.  
 Tolerance for Actual Lengths less than 6 ft is +/- 0.2", Actual Lengths between 6 ft and 16 ft is +/- 0.3", and Actual Lengths greater than 16 ft is +/- 0.6"  
 A - End Connector at both ends of Kurba (0.16" + 0.16" added to overall length)  
 B - End Connector at one end of Kurba and No Connector or Back Connector or Side Connector at other end of Kurba (0.16" + 0.08" added to overall length)  
 C - Any combination of No Connector, Back Connector, or Side Connector on each end of Kurba (0.08" + 0.08" added to overall length)

Nominal Length (in)	Actual Length (in)				Nominal Length (in)	Actual Length (in)				Nominal Length (in)	Actual Length (in)			
	W	A	B	C		W	A	B	C		W	A	B	C
7	2.1	6.9	6.8	6.7	125	38.1	125.0	124.9	124.8	243	74.1	243.1	243.0	242.9
10	3.1	10.2	10.1	10.0	128	39.1	128.3	128.2	128.1	246	75.1	246.4	246.3	246.2
(1 ft) 14	4.1	13.4	13.4	13.3	(11 ft) 132	40.1	131.5	131.5	131.4	250	76.1	249.7	249.6	249.5
17	5.1	16.7	16.6	16.6	135	41.1	134.8	134.7	134.7	(21 ft) 253	77.1	252.9	252.9	252.8
20	6.1	20.0	19.9	19.8	138	42.1	138.1	138.0	137.9	256	78.1	256.2	256.1	256.1
(2 ft) 23	7.1	23.3	23.2	23.1	141	43.1	141.4	141.3	141.2	260	79.1	259.5	259.4	259.3
27	8.1	26.6	26.5	26.4	(12 ft) 145	44.1	144.7	144.6	144.5	(22 ft) 263	80.1	262.8	262.7	262.6
30	9.1	29.8	29.8	29.7	148	45.1	148.0	147.9	147.8	266	81.1	266.1	266.0	265.9
33	10.1	33.1	33.0	33.0	151	46.1	151.2	151.2	151.1	269	82.1	269.3	269.3	269.2
(3 ft) 36	11.1	36.4	36.3	36.2	(13 ft) 155	47.1	154.5	154.4	154.4	273	83.1	272.6	272.5	272.5
40	12.1	39.7	39.6	39.5	158	48.1	157.8	157.7	157.6	(23 ft) 276	84.1	275.9	275.8	275.7
43	13.1	43.0	42.9	42.8	161	49.1	161.1	161.0	160.9	279	85.1	279.2	279.1	279.0
46	14.1	46.2	46.2	46.1	164	50.1	164.4	164.3	164.2	282	86.1	282.5	282.4	282.3
(4 ft) 50	15.1	49.5	49.5	49.4	(14 ft) 168	51.1	167.6	167.6	167.5	286	87.1	285.7	285.7	285.6
53	16.1	52.8	52.7	52.7	171	52.1	170.9	170.8	170.8	(24 ft) 289	88.1	289.0	288.9	288.9
56	17.1	56.1	56.0	55.9	174	53.1	174.2	174.1	174.0	292	89.1	292.3	292.2	292.1
(5 ft) 59	18.1	59.4	59.3	59.2	178	54.1	177.5	177.4	177.3	296	90.1	295.6	295.5	295.4
63	19.1	62.7	62.6	62.5	(15 ft) 181	55.1	180.8	180.7	180.6	(25 ft) 299	91.1	298.9	298.8	298.7
66	20.1	65.9	65.9	65.8	184	56.1	184.0	184.0	183.9	302	92.1	302.1	302.1	302.0
69	21.1	69.2	69.1	69.1	187	57.1	187.3	187.2	187.2	305	93.1	305.4	305.3	305.3
(6 ft) 73	22.1	72.5	72.4	72.3	(16 ft) 191	58.1	190.6	190.5	190.4	309	94.1	308.7	308.6	308.5
76	23.1	75.8	75.7	75.6	194	59.1	193.9	193.8	193.7	(26 ft) 312	95.1	312.0	311.9	311.8
79	24.1	79.1	79.0	78.9	197	60.1	197.2	197.1	197.0					
(7 ft) 82	25.1	82.3	82.3	82.2	200	61.1	200.4	200.4	200.3					
86	26.1	85.6	85.5	85.5	(17 ft) 204	62.1	203.7	203.6	203.6					
89	27.1	88.9	88.8	88.7	207	63.1	207.0	206.9	206.8					
92	28.1	92.2	92.1	92.0	210	64.1	210.3	210.2	210.1					
(8 ft) 96	29.1	95.5	95.4	95.3	214	65.1	213.6	213.5	213.4					
99	30.1	98.7	98.7	98.6	(18 ft) 217	66.1	216.8	216.8	216.7					
102	31.1	102.0	101.9	101.9	220	67.1	220.1	220.0	220.0					
105	32.1	105.3	105.2	105.1	223	68.1	223.4	223.3	223.2					
(9 ft) 109	33.1	108.6	108.5	108.4	(19 ft) 227	69.1	226.7	226.6	226.5					
112	34.1	111.9	111.8	111.7	230	70.1	230.0	229.9	229.8					
115	35.1	115.1	115.1	115.0	233	71.1	233.3	233.2	233.1					
(10 ft) 118	36.1	118.4	118.3	118.3	237	72.1	236.5	236.5	236.4					
122	37.1	121.7	121.6	121.5	(20 ft) 240	73.1	239.8	239.7	239.7					

Note: all values are rounded to the nearest 0.1 inch

Endcap (No Connector) -NPF

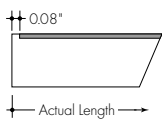

End Connector -IME

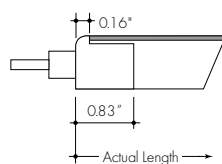

Back Connector -IMB

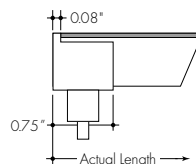

Side Connector -IMSA and -IMSB

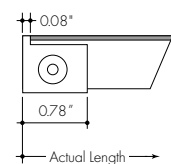



# Kurba Medium Horizontal Dynamic Color | Field Bendable 24V System



## RGB18SO | Power Consumption Per Fixture Length

Based on operation with PDCU series of power supplies. Use Actual Length for Order Code Entry.  
 Tolerance for Actual Lengths less than 6 ft is +/- 0.2", Actual Lengths between 6 ft and 16 ft is +/- 0.3", and Actual Lengths greater than 16 ft is +/- 0.6"  
 A - End Connector at both ends of Kurba (0.16" + 0.16" added to overall length)  
 B - End Connector at one end of Kurba and No Connector or Back Connector or Side Connector at other end of Kurba (0.16" + 0.08" added to overall length)  
 C - Any combination of No Connector, Back Connector, or Side Connector on each end of Kurba (0.08" + 0.08" added to overall length)

Nominal Length (in)	Actual Length (in)				Nominal Length (in)	Actual Length (in)				Nominal Length (in)	Actual Length (in)			
	W	A	B	C		W	A	B	C		W	A	B	C
8	2.5	8.2	8.1	8.0	150	45.7	149.9	149.8	149.8	292	88.9	291.7	291.6	291.5
(1 ft) 12	3.7	12.1	12.1	12.0	(13 ft) 154	46.9	153.9	153.8	153.7	296	90.1	295.6	295.5	295.4
16	4.9	16.1	16.0	15.9	158	48.1	157.8	157.7	157.6	(25 ft) 300	91.3	299.5	299.5	299.4
20	6.1	20.0	19.9	19.8	162	49.3	161.7	161.7	161.6	304	92.5	303.5	303.4	303.3
(2 ft) 24	7.3	23.9	23.9	23.8	166	50.5	165.7	165.6	165.5	308	93.7	307.4	307.3	307.2
28	8.5	27.9	27.8	27.7	(14 ft) 170	51.7	169.6	169.5	169.5	(26 ft) 312	94.9	311.3	311.3	311.2
32	9.7	31.8	31.7	31.7	174	52.9	173.5	173.5	173.4					
(3 ft) 36	10.9	35.8	35.7	35.6	178	54.1	177.5	177.4	177.3					
40	12.1	39.7	39.6	39.5	(15 ft) 182	55.3	181.4	181.3	181.3					
44	13.3	43.6	43.5	43.5	186	56.5	185.4	185.3	185.2					
(4 ft) 48	14.5	47.6	47.5	47.4	190	57.7	189.3	189.2	189.1					
52	15.7	51.5	51.4	51.3	(16 ft) 193	58.9	193.2	193.2	193.1					
56	16.9	55.4	55.4	55.3	197	60.1	197.2	197.1	197.0					
(5 ft) 60	18.1	59.4	59.3	59.2	201	61.3	201.1	201.0	200.9					
63	19.3	63.3	63.2	63.2	(17 ft) 205	62.5	205.0	205.0	204.9					
67	20.5	67.2	67.2	67.1	209	63.7	209.0	208.9	208.8					
(6 ft) 71	21.7	71.2	71.1	71.0	213	64.9	212.9	212.8	212.8					
75	22.9	75.1	75.0	75.0	(18 ft) 217	66.1	216.9	216.8	216.7					
79	24.1	79.1	79.0	78.9	221	67.3	220.8	220.7	220.6					
(7 ft) 83	25.3	83.0	82.9	82.8	225	68.5	224.7	224.6	224.6					
87	26.5	86.9	86.9	86.8	(19 ft) 229	69.7	228.7	228.6	228.5					
91	27.7	90.9	90.8	90.7	233	70.9	232.6	232.5	232.4					
(8 ft) 95	28.9	94.8	94.7	94.6	237	72.1	236.5	236.5	236.4					
99	30.1	98.7	98.7	98.6	(20 ft) 241	73.3	240.5	240.4	240.3					
103	31.3	102.7	102.6	102.5	245	74.5	244.4	244.3	244.3					
(9 ft) 107	32.5	106.6	106.5	106.5	249	75.7	248.4	248.3	248.2					
111	33.7	110.6	110.5	110.4	(21 ft) 253	76.9	252.3	252.2	252.1					
115	34.9	114.5	114.4	114.3	257	78.1	256.2	256.1	256.1					
(10 ft) 119	36.1	118.4	118.4	118.3	260	79.3	260.2	260.1	260.0					
123	37.3	122.4	122.3	122.2	(22 ft) 264	80.5	264.1	264.0	263.9					
126	38.5	126.3	126.2	126.1	268	81.7	268.0	268.0	267.9					
(11 ft) 130	39.7	130.2	130.2	130.1	272	82.9	272.0	271.9	271.8					
134	40.9	134.2	134.1	134.0	(23 ft) 276	84.1	275.9	275.8	275.8					
138	42.1	138.1	138.0	138.0	280	85.3	279.8	279.8	279.7					
(12 ft) 143	43.3	142.1	142.0	141.9	284	86.5	283.8	283.7	283.6					
146	44.5	146.0	145.9	145.8	(24 ft) 288	87.7	287.7	287.6	287.6					

Note: all values are rounded to the nearest 0.1 inch

Endcap (No Connector) -NPF

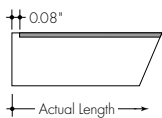

End Connector -IME

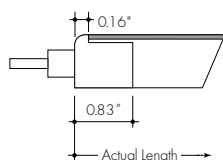

Back Connector -IMB

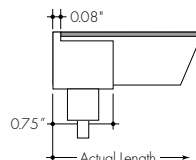

Side Connector -IMSA and -IMSB

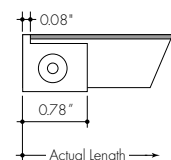



### RGBW1850 | Power Consumption Per Fixture Length

Based on operation with PDCU series of power supplies. Use Actual Length for Order Code Entry.  
 Tolerance for Actual Lengths less than 6 ft is +/- 0.2", Actual Lengths between 6 ft and 16 ft is +/- 0.3", and Actual Lengths greater than 16 ft is +/- 0.6"  
 A - End Connector at both ends of Kurba (0.16" + 0.16" added to overall length)  
 B - End Connector at one end of Kurba and No Connector or Back Connector or Side Connector at other end of Kurba (0.16" + 0.08" added to overall length)  
 C - Any combination of No Connector, Back Connector, or Side Connector on each end of Kurba (0.08" + 0.08" added to overall length)

Nominal Length (in)	Actual Length (in)				Nominal Length (in)	Actual Length (in)			
	W	A	B	C		W	A	B	C
8	3.1	8.2	8.1	8.0	150	57.1	149.9	149.8	149.8
(1 ft) 12	4.6	12.1	12.1	12.0	(13 ft) 154	58.6	153.9	153.8	153.7
16	6.1	16.1	16.0	15.9	158	60.1	157.8	157.7	157.6
20	7.6	20.0	19.9	19.8	162	61.6	161.7	161.7	161.6
(2 ft) 24	9.1	23.9	23.9	23.8	166	63.1	165.7	165.6	165.5
28	10.6	27.9	27.8	27.7	(14 ft) 170	64.6	169.6	169.5	169.5
32	12.1	31.8	31.7	31.7	174	66.1	173.5	173.5	173.4
(3 ft) 36	13.6	35.8	35.7	35.6	178	67.6	177.5	177.4	177.3
40	15.1	39.7	39.6	39.5	(15 ft) 182	69.1	181.4	181.3	181.3
44	16.6	43.6	43.5	43.5	186	70.6	185.4	185.3	185.2
(4 ft) 48	18.1	47.6	47.5	47.4	190	72.1	189.3	189.2	189.1
52	19.6	51.5	51.4	51.3	(16 ft) 193	73.6	193.2	193.2	193.1
56	21.1	55.4	55.4	55.3	197	75.1	197.2	197.1	197.0
(5 ft) 60	22.6	59.4	59.3	59.2	201	76.6	201.1	201.0	200.9
63	24.1	63.3	63.2	63.2	(17 ft) 205	78.1	205.0	205.0	204.9
67	25.6	67.2	67.2	67.1	209	79.6	209.0	208.9	208.8
(6 ft) 71	27.1	71.2	71.1	71.0	213	81.1	212.9	212.8	212.8
75	28.6	75.1	75.0	75.0	(18 ft) 217	82.6	216.9	216.8	216.7
79	30.1	79.1	79.0	78.9	221	84.1	220.8	220.7	220.6
(7 ft) 83	31.6	83.0	82.9	82.8	225	85.6	224.7	224.6	224.6
87	33.1	86.9	86.9	86.8	(19 ft) 229	87.1	228.7	228.6	228.5
91	34.6	90.9	90.8	90.7					
(8 ft) 95	36.1	94.8	94.7	94.6					
99	37.6	98.7	98.7	98.6					
103	39.1	102.7	102.6	102.5					
(9 ft) 107	40.6	106.6	106.5	106.5					
111	42.1	110.6	110.5	110.4					
115	43.6	114.5	114.4	114.3					
(10 ft) 119	45.1	118.4	118.4	118.3					
123	46.6	122.4	122.3	122.2					
126	48.1	126.3	126.2	126.1					
(11 ft) 130	49.6	130.2	130.2	130.1					
134	51.1	134.2	134.1	134.0					
138	52.6	138.1	138.0	138.0					
(12 ft) 143	54.1	142.1	142.0	141.9					
146	55.6	146.0	145.9	145.8					

Note: all values are rounded to the nearest 0.1 inch

Endcap (No Connector) -NPF

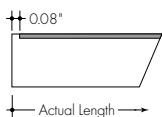

End Connector -IME

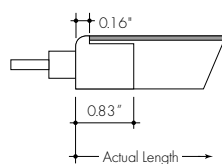

Back Connector -IMB

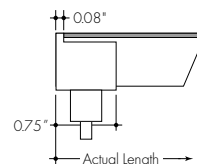

Side Connector -IMSA and -IMSB

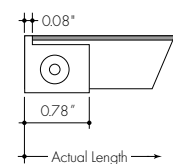





### SPI17SO | Power Consumption Per Fixture Length

Based on operation with PDCU series of power supplies. Use Actual Length for Order Code Entry.  
 Tolerance for Actual Lengths less than 6 ft is +/- 0.2", Actual Lengths between 6 ft and 16 ft is +/- 0.3", and Actual Lengths greater than 16 ft is +/- 0.6"  
 A - End Connector at both ends of Kurba (0.16" + 0.16" added to overall length)  
 B - End Connector at one end of Kurba and No Connector or Back Connector or Side Connector at other end of Kurba (0.16" + 0.08" added to overall length)  
 C - Any combination of No Connector, Back Connector, or Side Connector on each end of Kurba (0.08" + 0.08" added to overall length)

Nominal Length (in)	Actual Length (in)				Nominal Length (in)	Actual Length (in)			
	W	A	B	C		W	A	B	C
(1 ft) 10	3.9	10.2	10.1	10.0	187	71.4	187.3	187.2	187.2
15	5.7	15.1	15.0	14.9	(16 ft) 192	73.3	192.2	192.2	192.1
20	7.6	20.0	19.9	19.8	197	75.1	197.2	197.1	197.0
(2 ft) 25	9.5	24.9	24.8	24.8	(17 ft) 202	77.0	202.1	202.0	201.9
30	11.4	29.8	29.8	29.7	207	78.9	207.0	206.9	206.9
(3 ft) 35	13.3	34.8	34.7	34.6	212	80.8	211.9	211.9	211.8
40	15.1	39.7	39.6	39.5	(18 ft) 217	82.6	216.9	216.8	216.7
45	17.0	44.6	44.5	44.5	222	84.5	221.8	221.7	221.6
(4 ft) 50	18.9	49.5	49.5	49.4	(19 ft) 227	86.4	226.7	226.6	226.5
55	20.8	54.5	54.4	54.3					
(5 ft) 59	22.6	59.4	59.3	59.2					
64	24.5	64.3	64.2	64.1					
69	26.4	69.2	69.1	69.1					
(6 ft) 74	28.3	74.1	74.1	74.0					
79	30.1	79.1	79.0	78.9					
(7 ft) 84	32.0	84.0	83.9	83.8					
89	33.9	88.9	88.8	88.7					
(8 ft) 94	35.8	93.8	93.7	93.7					
99	37.6	98.7	98.7	98.6					
104	39.5	103.7	103.6	103.5					
(9 ft) 109	41.4	108.6	108.5	108.4					
114	43.3	113.5	113.4	113.3					
(10 ft) 119	45.1	118.4	118.4	118.3					
123	47.0	123.4	123.3	123.2					
128	48.9	128.3	128.2	128.1					
(11 ft) 133	50.8	133.2	133.1	133.0					
138	52.6	138.1	138.0	138.0					
(12 ft) 143	54.5	143.0	143.0	142.9					
148	56.4	148.0	147.9	147.8					
153	58.3	152.9	152.8	152.7					
(13 ft) 158	60.1	157.8	157.7	157.6					
163	62.0	162.7	162.6	162.6					
(14 ft) 168	63.9	167.6	167.6	167.5					
173	65.8	172.6	172.5	172.4					
(15 ft) 178	67.6	177.5	177.4	177.3					
182	69.5	182.4	182.3	182.2					

Note: all values are rounded to the nearest 0.1 inch

Endcap (No Connector) -NPF

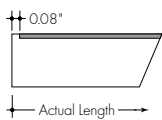

End Connector -IME

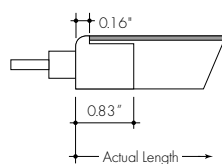

Back Connector -IMB

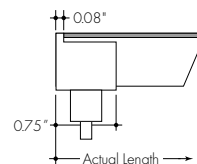

Side Connector -IMSA and -IMSB

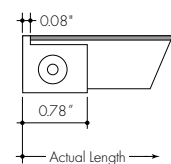



# Kurma Medium Horizontal Dynamic Color

# Field Bendable 24V System



## Power Supplies

See fixture and power supply instructions & spec sheet for wiring information. Dimming possible in select models - view Luminii website for list of compatible dimmers.

### For use with Warm Dim

#### Universal Power Supply 1% 120VAC - 277VAC

MODEL	POWER	OUTPUT
PDCU-D - IP20 Dry Series	30 - 30 W 60 - 60 W 96 - 96 W 3X96 - 3X96 W	24 - 24 VDC
PDCU-W - IP66 Wet Series	96 - 96 W 3X96 - 3X96 W	

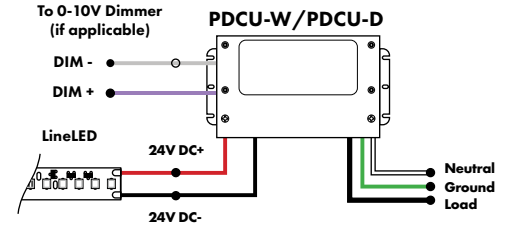

0-10V dims down to 1%, MLV/ELV/TRIAC dims down to 1%. For a complete list of compatible dimmers, see [Compatible Dimming Chart](#) on the Resources page.

MODELS	PDCU-W 96W	PDCU-W 3X96W	PDCU-D 30W	PDCU-D 60W	PDCU-D 96W	PDCU-D 3X96W
<b>Length</b>	8.66"	11.85"	6.10"	7.93"	8.25"	9.57"
<b>Width</b>	3.73"	4.32"	3.35"	3.35"	4.10"	5.94"
<b>Depth</b>	1.61"	1.81"	1.33"	1.32"	1.56"	1.13"

### For use with RGB/RGBW, RGB42/RGBW36 or with Tunable White

#### DMX 0% Dimming Power Supplies 120VAC - 277VAC

MODEL	POWER	OUTPUT
PSDMX-DMX Power Supply dims down to 0%	96 - 96 Watt 3X96 - 3 X 96 Watt	24-24 VDC

Features eldoLED's LINEARdrive configurable dimmable drivers. DDMX-RGBW DMX Decoder not required when purchasing this power supply.

MODELS	96W	3X96
<b>A Length</b>	14.40"	15.75"
<b>B Width</b>	5.20"	6.62"
<b>Depth</b>	2.60"	4.95"

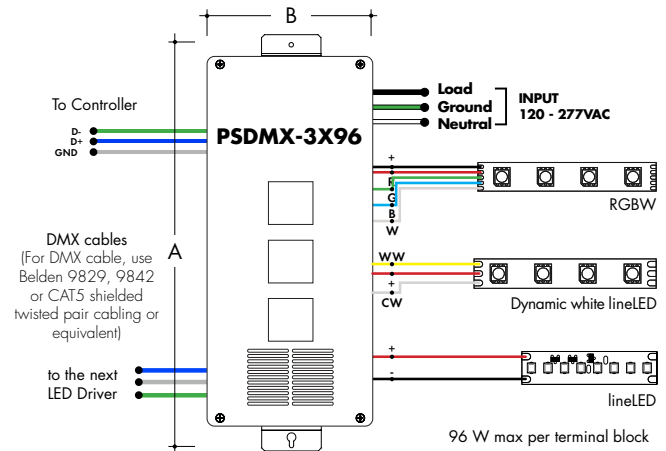
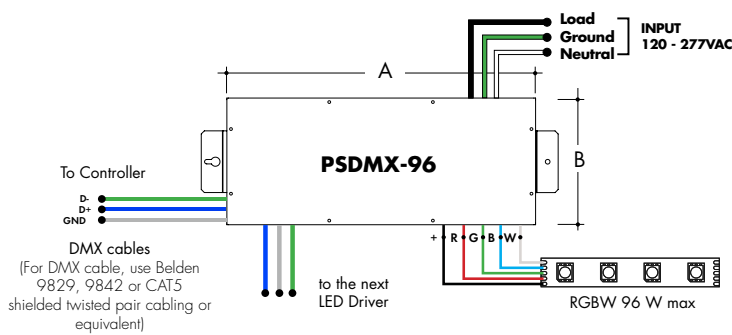



# Kurba Medium Horizontal Dynamic Color

Field Bendable 24V System



## For use with Tunable White

**Customizable Dim to Warm or Variable White via 0 - 10V**  
(for tunable white or warm dimming control of Dynamic option)

MODEL	POWER	OUTPUT	CONTROL
PS010VD-0-10 LED Driver	96-96 Watt	24-24 VDC	WW-Standard One Channel - Dim To Warm Curve W2C-Standard Two Channel - Dim 1: Intensity; Dim 2: CCT W21 - Standard Two Channel - Dim 1: Warm Channel Intensity; Dim 2: Cool Channel Intensity W1X-___Custom One Channel - Dim To Warm Curve W2X-___Custom two Channel - Dim 1: Intensity; Dim 2: CCT

MODELS	96W	3X96
<b>Length</b>	14.40"	15.0"
<b>Width</b>	5.20"	6.61"
<b>Depth</b>	2.60"	4.56"

Requires a 0-10V controller to work properly

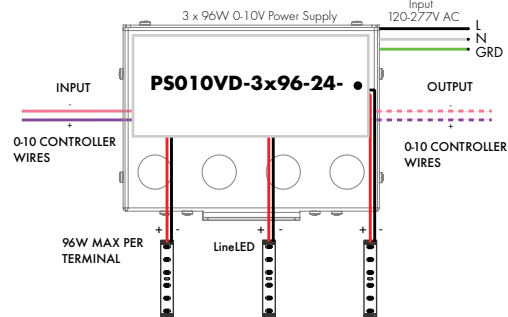
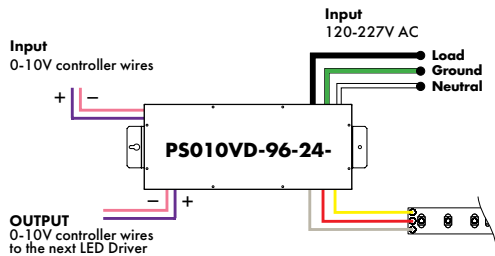

## For use with Tunable White

**DALI DT8 LED Driver, 120VAC - 277VAC**

MODEL	POWER	OUTPUT
PSDALI-DT8-DALI-DT8 LED Driver	96-96 Watt	24-24 VDC

Requires a controller and a decoder to work properly

MODELS	96W
<b>A Length</b>	14.40"
<b>B Width</b>	5.20"
<b>Depth</b>	2.60"

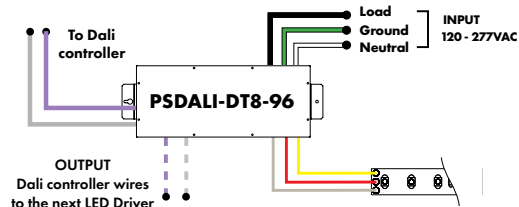

## For use with RGB/RGBW/Pixel

**Non-Dimming Power Supply 120VAC - 277VAC**

MODEL	POWER	OUTPUT	DIMMING	LOCATION
PSV-PSV Series	96-96 Watt	24-24 VDC	ND-Non Dimming	D-Dry location

Requires a controller and a decoder to work properly

MODELS	96W
<b>A Length</b>	14.40"
<b>B Width</b>	5.20"
<b>Depth</b>	2.60"

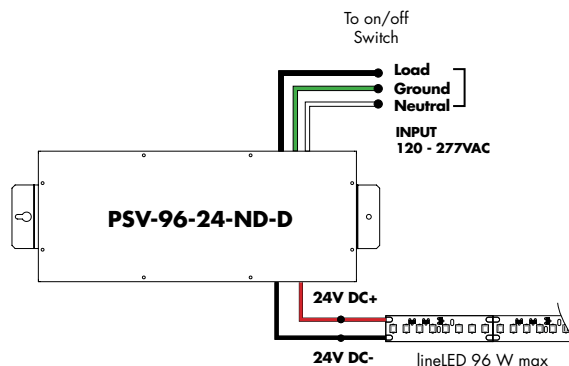



### Power Supplies

See fixture and power supply instructions & spec sheet for wiring information. Dimming possible in select models - view Luminii website for list of compatible dimmers.

### DMX-1Z-RGBW, DMX-3Z-RGBW

RGBW LED 1 or 3 Zone Controller

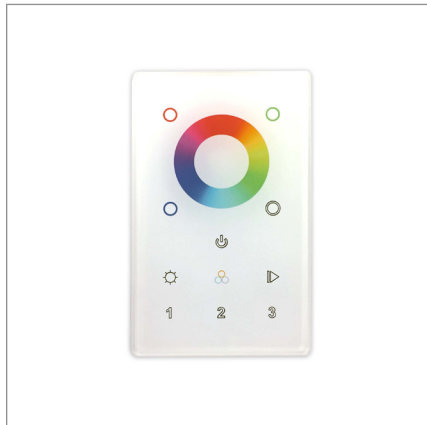

DMX /Wireless RGB-W wall-mount controller controls DMX lighting fixtures, wireless control of RGB-W lighting fixture or use both simultaneously. Fits in any standard US switch box. Includes all the outputs in the back of the controller.

Control brightness levels with a single touch, personalize and memorize 3 different scenes, and even create 3 variations of white.

#### Features

- 2 in 1 in-Wall Controller: DMX Control or Wireless RGB-W
- 65,000 Color Options, Dimming and Speed Control
- Memory Function
- 50 Foot Wireless Range
- Easily Fits Standard US Switch Boxes
- Touch Sensitive Glass Surface
- Includes 10 Built in Programs, or Create and Play Your Own

#### Operating Voltage

12 - 24V DC

#### Color Parameters

- Brightness
- Saturation
- Primary colors
- Fading
- Color changing speed

#### ORDERING CODE

MODEL	ZONES	COLOR
DMX - DMX Controller	3Z - Three Zone 1Z - One Zone	RGBW - Red, Green, Blue, & White

### Touch DMX Controller

Touchscreen digital LED controller

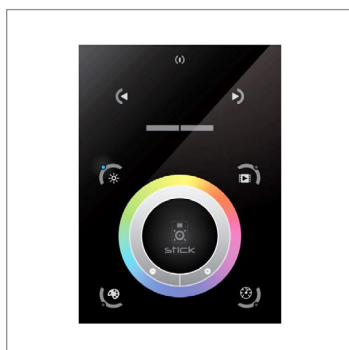

Programmable advanced DMX512 lighting controller featuring a touch-screen interface. Operates as stand alone controller or integrated with most architectural lighting control systems. Can controller endless DMX512 enabled devices.

Mounts to standard single or dual gang wall box with the included power supply inside the junction box. Terminal block design for power and data connections.

#### Features

- Sleek glass design which sits 0.43" from the wall
- Graphical color display to show selected environment
- Color/dimmer/speed palette
- Color temperature mixing
- Touch sensitive buttons. No mechanical parts
- Touch sensitive wheel allows for accurate color selection
- Multi-zone microSD memory
- Multi-room control with 500 scenes, 10 zones
- 1024 DMX channels. Control 340 RGB fixtures
- USB & Ethernet connectivity for programming and control

#### Power Supply

7 VDC (included)

#### Programmability

PC, Mac, Tablet, Smartphone

#### Output Signal

DMX512 (1024 channels)

#### Color Parameters

- Brightness
- Saturation
- Speed of color changing sequence
- Fading / dimming / brightness

#### MODEL

TSDMX-E

TSDMX-E - Touchscreen DMX controller



### DMX Decoder

DMX signal to RGBW decoder (required to operate DMX controller)

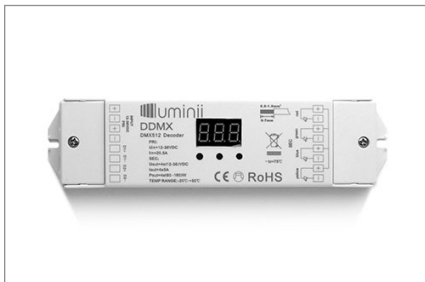

Translates controller DMX512 programs for RGB and white LED strips.

Unique DMX address for the decoder can be set easily and displayed by the numeric display on the case. Changing and resetting the DMX address requires manual input.

Use power repeater to expand output.

**Operating Voltage**

12-36 VDC

**Power Capacity**

up to 96W at 24V

**Operating Temperature Range**

from -4°F to +122°F in case

ORDERING CODE

MODEL

**DDMX-RGBW**

DDMX-RGBW - DMX decoder

### Smart Pixel Decoder

SPI signal to DMX signal decoder



The SR-DMX-SPI is a smart LED pixel decoder that controls RGB/RGBW pixel LED strips with SPI signal. Designed with an OLED backlit panel, the pixel controller allows for easy configuration of most settings. Four push buttons are available for control of the LED functions.

\*For pixel only.

**Features**

- 2 in 1 in-Wall Controller: DMX Control or Wireless RGB-W
- SPI signal output for RGB/RGBW pixel light control
- DMX512 controllable and RF/WIFI remote controllable
- Capable of addressing up to 1020 RGB pixels & 765 RGB pixels
- OLED panel allows for easy configuration

**Operating Voltage**

12 - 36V DC

**Power capacity**

up to 96W at 24V

**Operating temperature range**

from -4°F to +122°F in case

Model

**SR-DMX-SPI**

SR-DMX-SPI - Smart Pixel Decoder