

Features

Kurba Large is a dot free direct view, highly versatile, energy efficient and flexible LED strip suitable for outdoor wet locations capable of horizontal/side bends and vertical/top bends with a 6" bending radius. The silicone material offers excellent heat, weather, UV, and solvent resistance and has a special coating to repel dust and dirt accumulation.

Applications

Indoor/Outdoor dry & wet location

Average Life (L70)

50,000 hours

Materials

Silicone for red list approved, as well as heat, weather, UV, and solvent resistance

Approvals

24VDC Class 2 wet listed, IP68

Dimming

Dimable down to 1%. Dot Free even illumination. Also available with Black Lens

Warranty

3 years

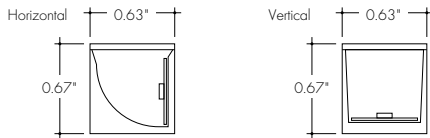

Finish Options (see page 2 for additional information)

Base White

Premium Black Red Green Blue



Technical Information

Bending Direction	Horizontal				Vertical		
Output	38LO	38SO	38MO	38HO	38LO	38SO	38MO
Light Output at 3000K	100 lm/ft	160 lm/ft	240 lm/ft	274 lm/ft	120 lm/ft	210 lm/ft	346 lm/ft
Average Power Consumption at 4'	1.83 W/ft	2.74 W/ft	3.66 W/ft	4.57 W/ft	1.83 W/ft	2.74 W/ft	3.66 W/ft
Efficacy	55 lm/W	58 lm/W	66 lm/W	60 lm/W	66 lm/W	77 lm/W	95 lm/W
Ordering Increment	2.19"				2.19"		
Maximum Run Length (In Series)	52'	36'	26'	19'	52'	36'	26'
Operating Temperature	-40°F to 149°F	-40°F to 140°F	-40°F to 131°F	-40°F to 113°F	-40°F to 149°F	-40°F to 140°F	-40°F to 131°F

CCT INFO / LUMEN MULTIPLIER	
Color Temperature	Multiplier (ref. -3000K)
2200K	0.82
2400K	1.00
2700K	1.00
3000K	1.06
3500K	1.06
4000K	1.06

Note: 80 CRI

Constraints

Horizontal Bend Direction

Bend LED in these positions only to avoid damage

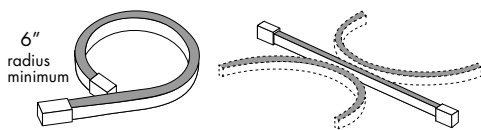

Illuminated surface shown in gray

Horizontal Prohibited Bends

Twisting or bending LED in these positions will cause damage

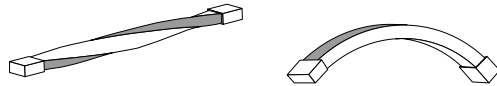

Illuminated surface shown in gray

Do not make sharp bends near the endcap

Vertical Bend Direction

Bend LED in these positions only to avoid damage

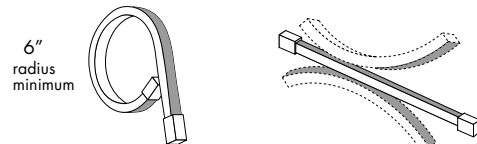

Illuminated surface shown in gray

Vertical Prohibited Bends

Twisting or bending LED in these positions will cause damage

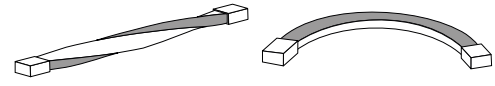

Illuminated surface shown in gray

Do not make sharp bends near the endcap

Ordering Code

MODEL	RATING	BEND DIRECTION	LENGTH	OUTPUT ^{1,2}	CCT	LENS	MOUNTING	FINISH	FEED POSITION LEFT	FEED POSITION RIGHT
KBL - Kurba Large	W - Wet	HB - Horizontal Bending	SEE PCC CHART ON PAGES 6 - 11	38LO - Low 38SO - Standard 38MO - Medium 38HO - High	22K - 2200K 24K - 2400K 27K - 2700K 30K - 3000K 35K - 3500K 40K - 4000K	SF - Silicone Frosted	NA - See Page 4 - 5 for orderable mounting accessories	WH - White BK - Black RED - Red GRN - Green BLU - Blue	INJECTION MOLD IME - End Feed 1 IMB - Back Feed 1 IMSA - Side 1 Feed IMSB - Side 2 Feed ³ NPF - No Power Feed ⁴	INJECTION MOLD IME - End Feed 1 IMB - Back Feed 1 IMSA - Side 1 Feed IMSB - Side 2 Feed ³ NPF - No Power Feed ⁴
		VB - Vertical Bending	SEE PCC CHART ON PAGES 6 - 11	38LO - Low 38SO - Standard 38MO - Medium	26K - 2600K 42K - 4200K	BL - Black Lens	NA - See Page 4 - 5 for orderable mounting accessories	BK - Black	Feeds come with 90° wire leads	

1 - Title 24 JA8 compliant depending on Output, CCT, and Lens selections. See Technical Information and Lens Transmission charts to calculate specific efficacies.
2 - 38HO - High Output Not Available for VB - Vertical Bending

3 - IMSB - Side 2 Feed not available with HB - Horizontal Bending
4 - NPF-NPF for Feed Position 1&2 is not a valid configuration option

Powerfeeds and Connectors

Power Feed Position Options and Orientation

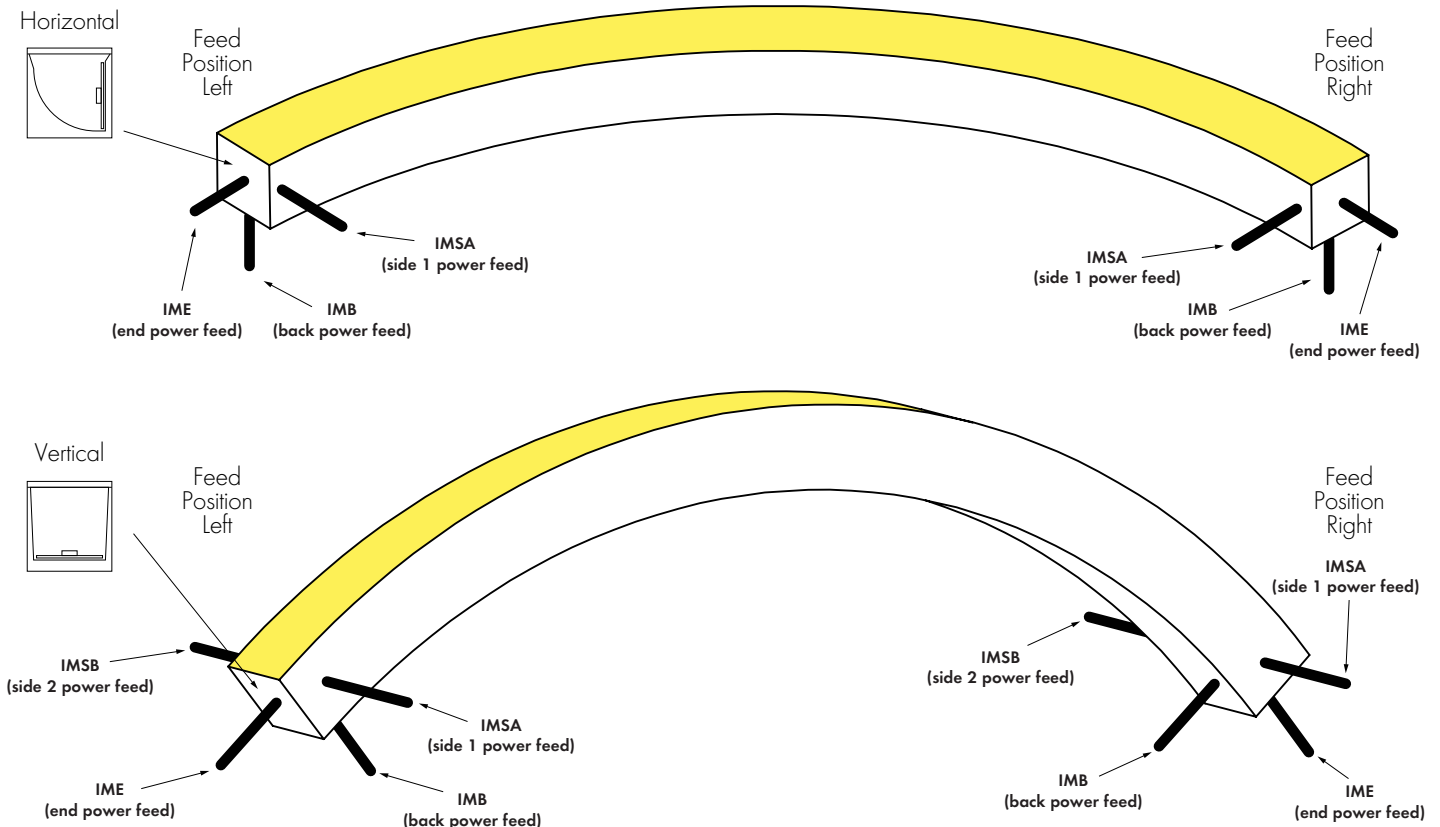

NOTE: IMSB - Side 2 Feed not available with HB - Horizontal Bending

Linking and Extension Cable Options

END CONNECTOR

Injection-molded End Connector
-IME

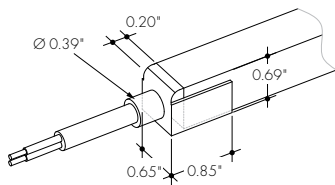

BACK CONNECTOR

Injection-molded Back Connector
-IMB

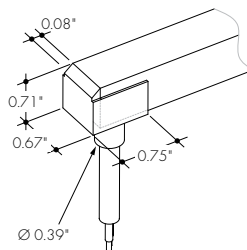

SIDE CONNECTOR

Injection-molded Side Connector
-MSA and -MSB

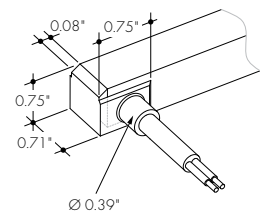

ENDCAP (NO CONNECTOR)

Injection-molded Cap (No Connector)
-NPF

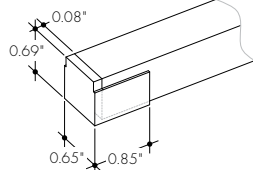

ANTI-WICKING FERRULE

Included on every power feed wire

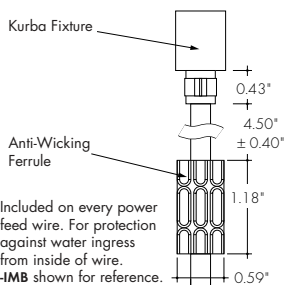

Included on every power feed wire. For protection against water ingress from inside of wire.
-IMB shown for reference.

Product Dimensions

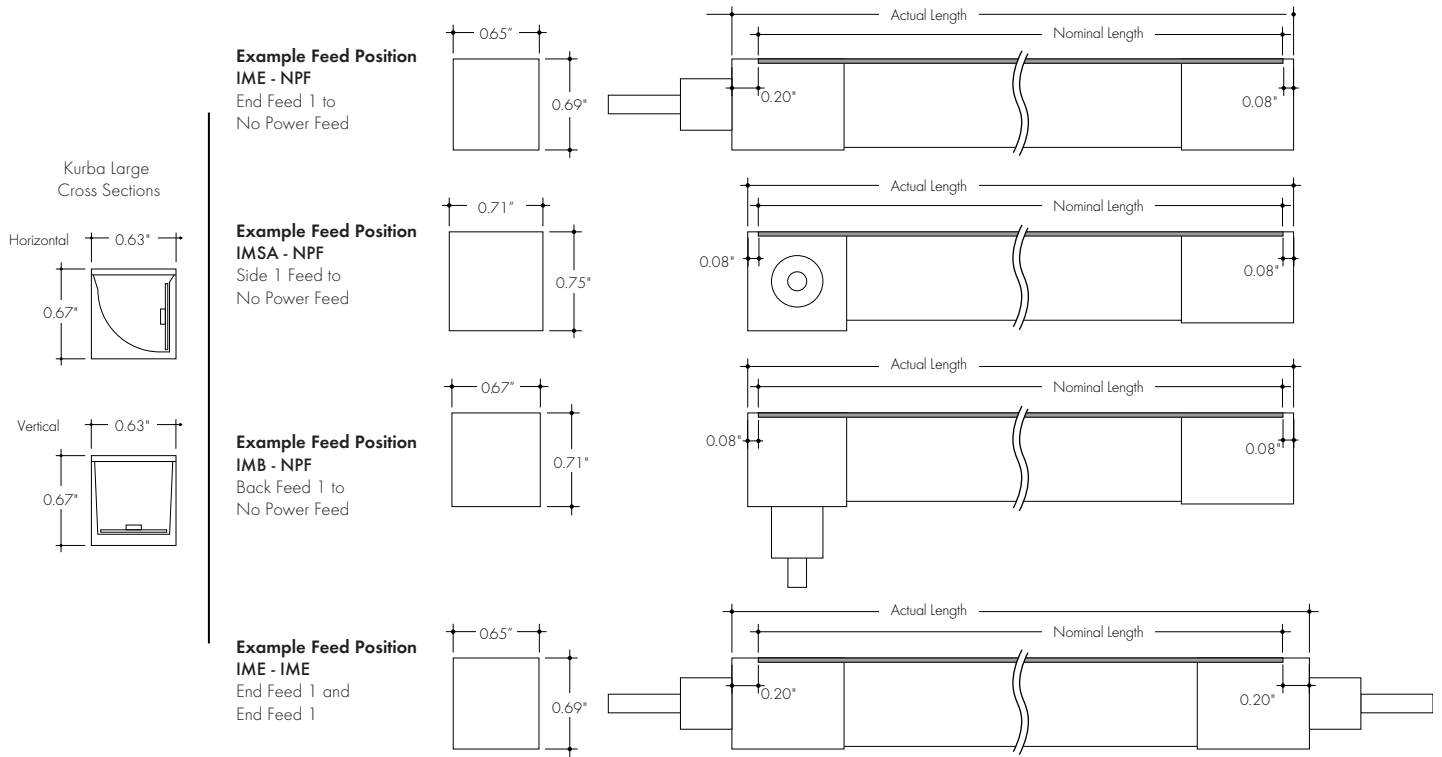

Finish Options

- A wide variety of finish options allowing complete customization of style and aesthetic.



Kurba's base finish is a crisp white which brings a timeless, clean aesthetic that brightens and enhances any space.



Also available with a blackout aesthetic - the Black Lens paired with the Black Finish provides for a sleek, all black profile that keeps the strip concealed in the off-state.

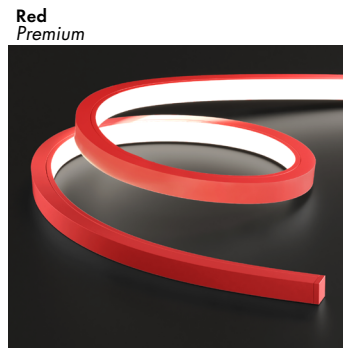

Red adds a bright and bold statement, perfect for creating a striking and dynamic ambiance with its vibrancy.

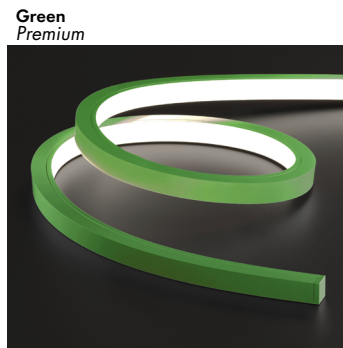

Green embraces a refreshing and natural feel, reminiscent of emerald green, add touch of tranquility and harmony to your space with this option.

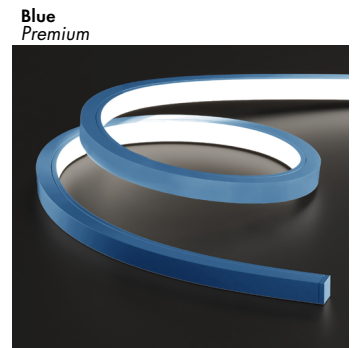

Blue evokes the serenity of the deep sea by combining vivid cobalt and azure tones.

Light Transmission and Dotting

Output Options	Lens/Accessory					
	Silicone Frosted/ White Finish	Silicone Frosted/ Red Finish	Silicone Frosted/ Green Finish	Silicone Frosted/ Blue Finish	Silicone Frosted/ Black Finish	Black Lens/ Black Finish
38LO	ND	ND	ND	ND	ND	ND
38SO	ND	ND	ND	ND	ND	ND
38MO	ND	ND	ND	ND	ND	ND
38HO	ND	ND	ND	ND	ND	ND
Transmission Percentage	100%	80%	80%	80%	80%	17%

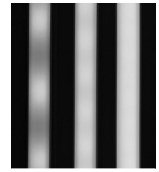

CD SD ND
CD - Clear Dotting
SD - Slight Dotting
ND - No Dotting

Mounting Accessories

MC-KBL-SAP-SM-0.8-SA

KBL Mounting Channel, Serrated Aluminum Profile, Surface Mount, 0.8in, Silver Anodized

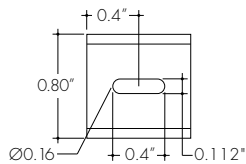
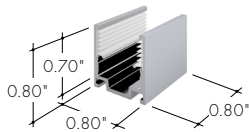

For use with light strip mounted to the ceiling. 1 recommended every 8 in.

MC-KBL-SAP-SM-78-SA

KBL Mounting Channel, Serrated Aluminum Profile, Surface Mount, 78in, Silver Anodized

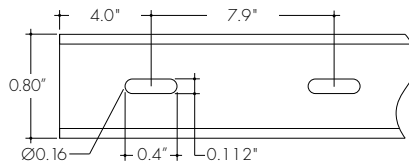
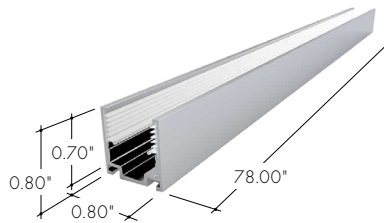

For use with light strip mounted to the ceiling.

MC-KBL-FSAP-TR-78-SA

KBL Mounting Channel, Flanged Serrated Aluminum Profile, Trimmed Recessed Mount, 78in, Silver Anodized

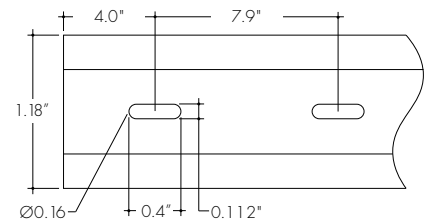
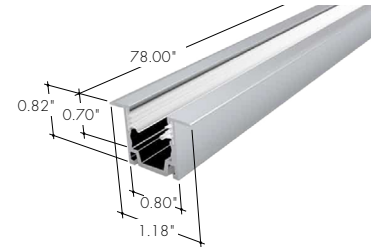

Flanged aluminum mounting channel providing grip. For use with light strip recessed into the ceiling.

MC-KBL-RCWY-SM-78-SA

KBL Mounting Channel, Raceway, Surface Mount, 78in, Silver Anodized

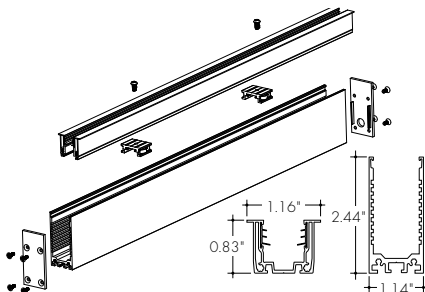

Raceway channel allows for hidden cable management and is a superb option where tidiness is required. **NOTE:** Compatible with **IMB** - Back Feed only

MC-KBL-BSSP-3D-SM-34-SS

KBL Mounting Channel, Bendable Stainless Steel Profile, 3D Bending, Surface Mount, 34in, Stainless Steel



For use with light strip mounted to the ceiling.

MC-KBL-BSAP-HB-SM-38-SA

KBL Mounting Channel, Bendable Serrated Aluminum Profile, Horizontal Bending, Surface Mount, 38in, Silver Anodized

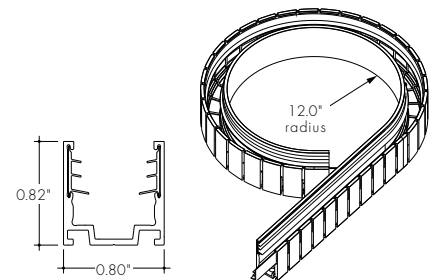

For use with light strip mounted to the ceiling. **NOTE:** Not Available on Vertical Bending.

Mounting Accessories and Optional Connectors

MC-KBL-BANP-3D-SM-78-XX
 KBL Mounting Channel, Bendable Anole Profile, 3D Bending, Surface Mount, 78in, 6" bending radius

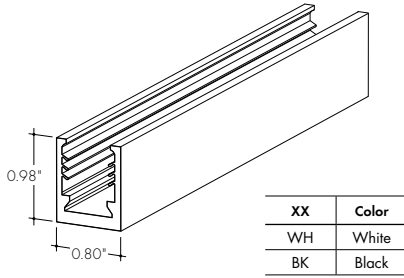

LVSP-WET
 Splice box: wet rated, low voltage, gray

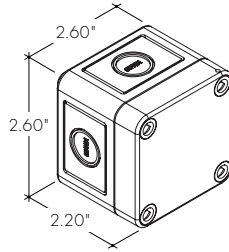

LVSP-WET-CM
 Connector for splice box, low voltage for cable management, gray

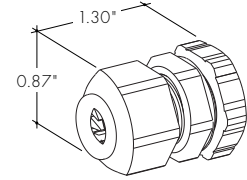

Photometry

KBL-W-HB-48-38HO-30K-SF-NA-WH

Kurba Large, Horizontal Bend, 4ft, 3000K, 38HO output, Silicone Frosted Lens

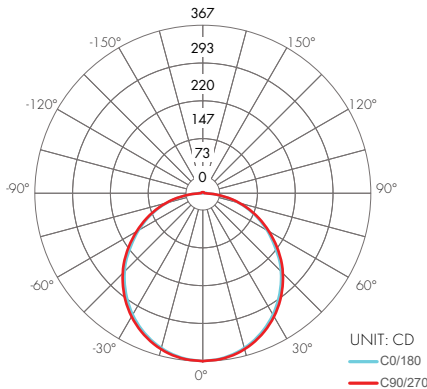

Zonal Lumen Summary 3000K

Zone	Lumen	% Fixture
0-30	283	25.8%
0-40	389	35.3%
0-60	826	75.3%
0-90	1082	98.7%
0-180	1096	100.0%

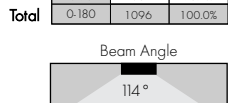

KBL-W-VB-48-38HMO-30K-SF-NA-WH

Kurba Large, Vertical Bend, 4ft, 3000K, 38MO output, Silicone Frosted Lens

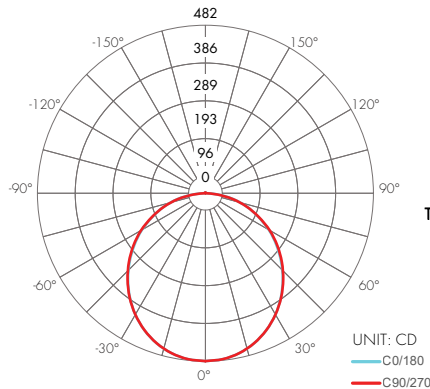

Zonal Lumen Summary 3000K

Zone	Lumen	% Fixture
0-30	369	26.7%
0-40	506	36.6%
0-60	1059	76.5%
0-90	1375	99.3%
0-180	1384	100.0%

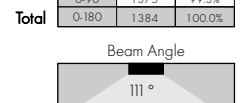

38LO | Power Consumption Per Fixture Length

Based on operation with PDCU series of power supplies. Use Actual Length for Order Code Entry.
 Tolerance for Actual Lengths less than 6 ft is +/- 0.2", Actual Lengths between 6 ft and 16 ft is +/- 0.3", and Actual Lengths greater than 16 ft is +/- 0.6"
 A - End Connector at both ends of Kurba (0.20" + 0.20" added to overall length)
 B - End Connector at one end of Kurba and No Connector or Back Connector or Side Connector at other end of Kurba (0.20" + 0.08" added to overall length)
 C - Any combination of No Connector, Back Connector, or Side Connector on each end of Kurba (0.08" + 0.08" added to overall length)

Nominal Length (in)	Actual Length (in)				Nominal Length (in)	Actual Length (in)				Nominal Length (in)	Actual Length (in)				Nominal Length (in)	Actual Length (in)				Nominal Length (in)	Actual Length (in)			
	W	A	B	C		W	A	B	C		W	A	B	C		W	A	B	C		W	A	B	C
7	1.1	7.0	6.8	6.7	86	13.1	85.7	85.6	85.5	165	25.1	164.5	164.3	164.2	243	37.1	243.2	243.1	243.0	322	49.1	321.9	321.8	321.7
9	1.4	9.1	9.0	8.9	88	13.4	87.9	87.8	87.7	167	25.4	166.6	166.5	166.4	246	37.4	245.4	245.3	245.1	(27 ft) 324	49.4	324.1	324.0	323.9
(1 ft) 11	1.7	11.3	11.2	11.1	90	13.7	90.1	90.0	89.8	(14 ft) 169	25.7	168.8	168.7	168.6	248	37.7	247.6	247.5	247.3	326	49.7	326.3	326.2	326.1
14	2.1	13.5	13.4	13.3	92	14.1	92.3	92.2	92.0	171	26.1	171.0	170.9	170.8	250	38.1	249.8	249.6	249.5	329	50.1	328.5	328.4	328.3
16	2.4	15.7	15.6	15.5	95	14.4	94.5	94.3	94.2	173	26.4	173.2	173.1	173.0	(21 ft) 252	38.4	252.0	251.8	251.7	331	50.4	330.7	330.6	330.5
18	2.7	17.9	17.8	17.7	(8 ft) 97	14.7	96.6	96.5	96.4	176	26.7	175.4	175.3	175.2	254	38.7	254.1	254.0	253.9	333	50.7	332.9	332.8	332.6
20	3.1	20.1	20.0	19.8	99	15.1	98.8	98.7	98.6	178	27.1	177.6	177.5	177.3	257	39.1	256.3	256.2	256.1	(28 ft) 335	51.1	335.1	335.0	334.8
22	3.4	22.3	22.2	22.0	101	15.4	101.0	100.9	100.8	(15 ft) 180	27.4	179.8	179.6	179.5	259	39.4	258.5	258.4	258.3	337	51.4	337.3	337.1	337.0
(2 ft) 24	3.7	24.5	24.3	24.2	103	15.7	103.2	103.1	103.0	182	27.7	182.0	181.8	181.7	261	39.7	260.7	260.6	260.5	339	51.7	339.4	339.3	339.2
27	4.1	26.6	26.5	26.4	106	16.1	105.4	105.3	105.2	184	28.1	184.1	184.0	183.9	(22 ft) 263	40.1	262.9	262.8	262.6	342	52.1	341.6	341.5	341.4
29	4.4	28.8	28.7	28.6	(9 ft) 108	16.4	107.6	107.5	107.3	187	28.4	186.3	186.2	186.1	265	40.4	265.1	265.0	264.8	344	52.4	343.8	343.7	343.6
31	4.7	31.0	30.9	30.8	110	16.7	109.8	109.7	109.5	189	28.7	188.5	188.4	188.3	268	40.7	267.3	267.1	267.0	346	52.7	346.0	345.9	345.8
33	5.1	33.2	33.1	33.0	112	17.1	112.0	111.8	111.7	(16 ft) 191	29.1	190.7	190.6	190.5	270	41.1	269.5	269.3	269.2	(29 ft) 348	53.1	348.2	348.1	348.0
(3 ft) 35	5.4	35.4	35.3	35.2	114	17.4	114.1	114.0	113.9	193	29.4	192.9	192.8	192.7	272	41.4	271.6	271.5	271.4	350	53.4	350.4	350.3	350.1
38	5.7	37.6	37.5	37.3	116	17.7	116.3	116.2	116.1	195	29.7	195.1	195.0	194.8	274	41.7	273.8	273.7	273.6	353	53.7	352.6	352.5	352.3
40	6.1	39.8	39.7	39.5	119	18.1	118.5	118.4	118.3	198	30.1	197.3	197.1	197.0	(23 ft) 276	42.1	276.0	275.9	275.8	355	54.1	354.8	354.6	354.5
42	6.4	42.0	41.8	41.7	(10 ft) 121	18.4	120.7	120.6	120.5	200	30.4	199.5	199.3	199.2	279	42.4	278.2	278.1	278.0	357	54.4	356.9	356.8	356.7
44	6.7	44.1	44.0	43.9	123	18.7	122.9	122.8	122.7	202	30.7	201.6	201.5	201.4	281	42.7	280.4	280.3	280.1	(30 ft) 359	54.7	359.1	359.0	358.9
46	7.1	46.3	46.2	46.1	125	19.1	125.1	125.0	124.8	(17 ft) 204	31.1	203.8	203.7	203.6	283	43.1	282.6	282.5	282.3	361	55.1	361.3	361.2	361.1
(4 ft) 49	7.4	48.5	48.4	48.3	127	19.4	127.3	127.1	127.0	206	31.4	206.0	205.9	205.8	285	43.4	284.8	284.6	284.5	364	55.4	363.5	363.4	363.3
51	7.7	50.7	50.6	50.5	130	19.7	129.5	129.3	129.2	208	31.7	208.2	208.1	208.0	(24 ft) 287	43.7	286.9	286.8	286.7	366	55.7	365.7	365.6	365.5
53	8.1	52.9	52.8	52.7	(11 ft) 132	20.1	131.6	131.5	131.4	211	32.1	210.4	210.3	210.2	289	44.1	289.1	289.0	288.9	368	56.1	367.9	367.8	367.6
55	8.4	55.1	55.0	54.8	134	20.4	133.8	133.7	133.6	213	32.4	212.6	212.5	212.3	292	44.4	291.3	291.2	291.1	370	56.4	370.1	370.0	369.8
57	8.7	57.3	57.2	57.0	136	20.7	136.0	135.9	135.8	(18 ft) 215	32.7	214.8	214.6	214.5	294	44.7	293.5	293.4	293.3	(31 ft) 372	56.7	372.3	372.1	372.0
(5 ft) 60	9.1	59.5	59.3	59.2	138	21.1	138.2	138.1	138.0	217	33.1	217.0	216.8	216.7	296	45.1	295.7	295.6	295.5	374	57.1	374.4	374.3	374.2
62	9.4	61.6	61.5	61.4	141	21.4	140.4	140.3	140.2	219	33.4	219.1	219.0	218.9	298	45.4	297.9	297.8	297.6	377	57.4	376.6	376.5	376.4
64	9.7	63.8	63.7	63.6	143	21.7	142.6	142.5	142.3	222	33.7	221.3	221.2	221.1	(25 ft) 300	45.7	300.1	300.0	299.8	379	57.7	378.8	378.7	378.6
66	10.1	66.0	65.9	65.8	(12 ft) 145	22.1	144.8	144.6	144.5	224	34.1	223.5	223.4	223.3	302	46.1	302.3	302.1	302.0	381	58.1	381.0	380.9	380.8
68	10.4	68.2	68.1	68.0	147	22.4	147.0	146.8	146.7	226	34.4	225.7	225.6	225.5	304	46.4	304.4	304.3	304.2	(32 ft) 383	58.4	383.2	383.1	383.0
70	10.7	70.4	70.3	70.2	149	22.7	149.1	149.0	148.9	(19 ft) 228	34.7	227.9	227.8	227.6	307	46.7	306.6	306.5	306.4					
(6 ft) 73	11.1	72.6	72.5	72.3	152	23.1	151.3	151.2	151.1	230	35.1	230.1	230.0	229.8	309	47.1	308.8	308.7	308.6					
75	11.4	74.8	74.7	74.5	154	23.4	153.5	153.4	153.3	233	35.4	232.3	232.1	232.0	(26 ft) 311	47.4	311.0	310.9	310.8					
77	11.7	77.0	76.8	76.7	(13 ft) 156	23.7	155.7	155.6	155.5	235	35.7	234.5	234.3	234.2	313	47.7	313.2	313.1	313.0					
80	12.1	79.1	79.0	78.9	158	24.1	157.9	157.8	157.7	237	36.1	236.6	236.5	236.4	315	48.1	315.4	315.3	315.1					
81	12.4	81.3	81.2	81.1	160	24.4	160.1	160.0	159.8	(20 ft) 239	36.4	238.8	238.7	238.6	318	48.4	317.6	317.5	317.3					
(7 ft) 84	12.7	83.5	83.4	83.3	162	24.7	162.3	162.1	162.0	241	36.7	241.0	240.9	240.8	320	48.7	319.8	319.6	319.5					

Note: all values are rounded to the nearest 0.1 inch

Endcap (No Connector) -NPF

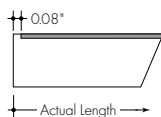

End Connector -IME

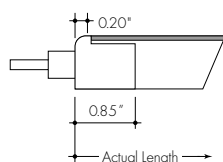

Back Connector -IMB

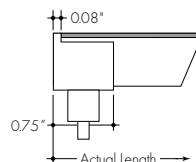

Side Connector -IMSA -IMSB

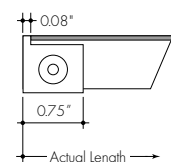

38LO | Power Consumption Per Fixture Length cont.

Based on operation with PDCU series of power supplies. Use Actual Length for Order Code Entry.
 Tolerance for Actual Lengths less than 6 ft is +/- 0.2", Actual Lengths between 6 ft and 16 ft is +/- 0.3", and Actual Lengths greater than 16 ft is +/- 0.6"
 A - End Connector at both ends of Kurba (0.20" + 0.20" added to overall length)
 B - End Connector at one end of Kurba and No Connector or Back Connector or Side Connector at other end of Kurba (0.20" + 0.08" added to overall length)
 C - Any combination of No Connector, Back Connector, or Side Connector on each end of Kurba (0.08" + 0.08" added to overall length)

Nominal Length (in)	Actual Length (in)				Nominal Length (in)	Actual Length (in)				Nominal Length (in)	Actual Length (in)				Nominal Length (in)	Actual Length (in)			
	W	A	B	C		W	A	B	C		W	A	B	C		W	A	B	C
385	58.7	385.4	385.3	385.1	464	70.8	464.1	464.0	463.9	543	82.8	542.9	542.8	542.6	622	94.8	621.6	621.5	621.4
388	59.1	387.6	387.5	387.3	466	71.1	466.3	466.2	466.1	545	83.1	545.1	544.9	544.8	624	95.1	623.8	623.7	623.6
390	59.4	389.8	389.6	389.5	(39 ft) 469	71.4	468.5	468.4	468.3	547	83.4	547.3	547.1	547.0	(52 ft) 626	95.4	626.0	625.9	625.8
392	59.7	391.9	391.8	391.7	471	71.8	470.7	470.6	470.5	549	83.8	549.4	549.3	549.2					
394	60.1	394.1	394.0	393.9	473	72.1	472.9	472.8	472.6	552	84.1	551.6	551.5	551.4					
(33 ft) 396	60.4	396.3	396.2	396.1	475	72.4	475.1	474.9	474.8	(46 ft) 554	84.4	553.8	553.7	553.6					
399	60.7	398.5	398.4	398.3	477	72.8	477.3	477.1	477.0	556	84.8	556.0	555.9	555.8					
401	61.1	400.7	400.6	400.5	479	73.1	479.4	479.3	479.2	558	85.1	558.2	558.1	557.9					
403	61.4	402.9	402.8	402.6	(40 ft) 482	73.4	481.6	481.5	481.4	560	85.4	560.4	560.3	560.1					
405	61.7	405.1	404.9	404.8	484	73.8	483.8	483.7	483.6	563	85.8	562.6	562.4	562.3					
(34 ft) 407	62.1	407.3	407.1	407.0	486	74.1	486.0	485.9	485.8	(47 ft) 565	86.1	564.7	564.6	564.5					
409	62.4	409.4	409.3	409.2	488	74.4	488.2	488.1	488.0	567	86.4	566.9	566.8	566.7					
412	62.7	411.6	411.5	411.4	490	74.8	490.4	490.3	490.1	569	86.8	569.1	569.0	568.9					
414	63.1	413.8	413.7	413.6	(41 ft) 493	75.1	492.6	492.4	492.3	571	87.1	571.3	571.2	571.1					
416	63.4	416.0	415.9	415.8	495	75.4	494.8	494.6	494.5	574	87.4	573.5	573.4	573.3					
418	63.7	418.2	418.1	418.0	497	75.8	496.9	496.8	496.7	576	87.8	575.7	575.6	575.4					
(35 ft) 420	64.1	420.4	420.3	420.1	499	76.1	499.1	499.0	498.9	(48 ft) 578	88.1	577.9	577.8	577.6					
423	64.4	422.6	422.4	422.3	501	76.4	501.3	501.2	501.1	580	88.4	580.1	579.9	579.8					
425	64.7	424.8	424.6	424.5	504	76.8	503.5	503.4	503.3	582	88.8	582.2	582.1	582.0					
427	65.1	426.9	426.8	426.7	(42 ft) 506	77.1	505.7	505.6	505.4	584	89.1	584.4	584.3	584.2					
429	65.4	429.1	429.0	428.9	508	77.4	507.9	507.8	507.6	587	89.4	586.6	586.5	586.4					
431	65.7	431.3	431.2	431.1	510	77.8	510.1	509.9	509.8	(49 ft) 589	89.8	588.8	588.7	588.6					
(36 ft) 434	66.1	433.5	433.4	433.3	512	78.1	512.3	512.1	512.0	591	90.1	591.0	590.9	590.8					
436	66.4	435.7	435.6	435.5	514	78.4	514.4	514.3	514.2	593	90.4	593.2	593.1	592.9					
438	66.8	437.9	437.8	437.6	(43 ft) 517	78.8	516.6	516.5	516.4	595	90.8	595.4	595.3	595.1					
440	67.1	440.1	439.9	439.8	519	79.1	518.8	518.7	518.6	598	91.1	597.6	597.4	597.3					
442	67.4	442.3	442.1	442.0	521	79.4	521.0	520.9	520.8	600	91.4	599.7	599.6	599.5					
(37 ft) 444	67.8	444.4	444.3	444.2	523	79.8	523.2	523.1	522.9	(50 ft) 602	91.8	601.9	601.8	601.7					
447	68.1	446.6	446.5	446.4	525	80.1	525.4	525.3	525.1	604	92.1	604.1	604.0	603.9					
449	68.4	448.8	448.7	448.6	528	80.4	527.6	527.4	527.3	606	92.4	606.3	606.2	606.1					
451	68.8	451.0	450.9	450.8	(44 ft) 530	80.8	529.8	529.6	529.5	609	92.8	608.5	608.4	608.3					
453	69.1	453.2	453.1	453.0	532	81.1	531.9	531.8	531.7	611	93.1	610.7	610.6	610.4					
455	69.4	455.4	455.3	455.1	534	81.4	534.1	534.0	533.9	(51 ft) 613	93.4	612.9	612.8	612.6					
(38 ft) 458	69.8	457.6	457.4	457.3	536	81.8	536.3	536.2	536.1	615	93.8	615.1	614.9	614.8					
460	70.1	459.8	459.6	459.5	539	82.1	538.5	538.4	538.3	617	94.1	617.2	617.1	617.0					
462	70.4	461.9	461.8	461.7	(45 ft) 541	82.4	540.7	540.6	540.4	621	94.4	619.4	619.3	619.2					

Note: all values are rounded to the nearest 0.1 inch

Endcap (No Connector) -NPF

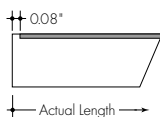

End Connector -IME

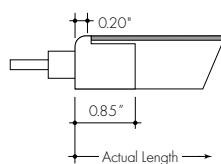

Back Connector -IMB

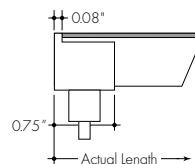

Side Connector -IMSA -IMSB

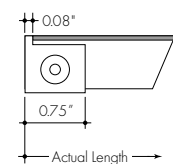

38SO | Power Consumption Per Fixture Length

Based on operation with PDCU series of power supplies. Use Actual Length for Order Code Entry.
 Tolerance for Actual Lengths less than 6 ft is +/- 0.2". Actual Lengths between 6 ft and 16 ft is +/- 0.3", and Actual Lengths greater than 16 ft is +/- 0.6"
 A - End Connector at both ends of Kurba (0.20" + 0.20" added to overall length)
 B - End Connector at one end of Kurba and No Connector or Back Connector or Side Connector at other end of Kurba (0.20" + 0.08" added to overall length)
 C - Any combination of No Connector, Back Connector, or Side Connector on each end of Kurba (0.08" + 0.08" added to overall length)

Nominal Length (in)	Actual Length (in)				Nominal Length (in)	Actual Length (in)				Nominal Length (in)	Actual Length (in)			
	W	A	B	C		W	A	B	C		W	A	B	C
7	1.6	7.0	6.8	6.7	86	19.6	85.7	85.6	85.5	165	37.6	164.5	164.3	164.2
9	2.1	9.1	9.0	8.9	88	20.1	87.9	87.8	87.7	167	38.1	166.6	166.5	166.4
(1 ft) 11	2.6	11.3	11.2	11.1	90	20.6	90.1	90.0	89.8	(14 ft) 169	38.6	168.8	168.7	168.6
14	3.1	13.5	13.4	13.3	92	21.1	92.3	92.2	92.0	171	39.1	171.0	170.9	170.8
16	3.6	15.7	15.6	15.5	95	21.6	94.5	94.3	94.2	173	39.6	173.2	173.1	173.0
18	4.1	17.9	17.8	17.7	(8 ft) 97	22.1	96.6	96.5	96.4	176	40.1	175.4	175.3	175.2
20	4.6	20.1	20.0	19.8	99	22.6	98.8	98.7	98.6	178	40.6	177.6	177.5	177.3
22	5.1	22.3	22.2	22.0	101	23.1	101.0	100.9	100.8	(15 ft) 180	41.1	179.8	179.6	179.5
(2 ft) 24	5.6	24.5	24.3	24.2	103	23.6	103.2	103.1	103.0	182	41.6	182.0	181.8	181.7
27	6.1	26.6	26.5	26.4	106	24.1	105.4	105.3	105.2	184	42.1	184.1	184.0	183.9
29	6.6	28.8	28.7	28.6	(9 ft) 108	24.6	107.6	107.5	107.3	187	42.6	186.3	186.2	186.1
31	7.1	31.0	30.9	30.8	110	25.1	109.8	109.7	109.5	189	43.1	188.5	188.4	188.3
33	7.6	33.2	33.1	33.0	112	25.6	112.0	111.8	111.7	(16 ft) 191	43.6	190.7	190.6	190.5
(3 ft) 35	8.1	35.4	35.3	35.2	114	26.1	114.1	114.0	113.9	193	44.1	192.9	192.8	192.7
38	8.6	37.6	37.5	37.3	116	26.6	116.3	116.2	116.1	195	44.6	195.1	195.0	194.8
40	9.1	39.8	39.7	39.5	119	27.1	118.5	118.4	118.3	198	45.1	197.3	197.1	197.0
42	9.6	42.0	41.8	41.7	(10 ft) 121	27.6	120.7	120.6	120.5	200	45.6	199.5	199.3	199.2
44	10.1	44.1	44.0	43.9	123	28.1	122.9	122.8	122.7	202	46.1	201.6	201.5	201.4
46	10.6	46.3	46.2	46.1	125	28.6	125.1	125.0	124.8	(17 ft) 204	46.6	203.8	203.7	203.6
(4 ft) 49	11.1	48.5	48.4	48.3	127	29.1	127.3	127.1	127.0	206	47.1	206.0	205.9	205.8
51	11.6	50.7	50.6	50.5	130	29.6	129.5	129.3	129.2	208	47.6	208.2	208.1	208.0
53	12.1	52.9	52.8	52.7	(11 ft) 132	30.1	131.6	131.5	131.4	211	48.1	210.4	210.3	210.2
55	12.6	55.1	55.0	54.8	134	30.6	133.8	133.7	133.6	213	48.6	212.6	212.5	212.3
57	13.1	57.3	57.2	57.0	136	31.1	136.0	135.9	135.8	(18 ft) 215	49.1	214.8	214.6	214.5
(5 ft) 60	13.6	59.5	59.3	59.2	138	31.6	138.2	138.1	138.0	217	49.6	217.0	216.8	216.7
62	14.1	61.6	61.5	61.4	141	32.1	140.4	140.3	140.2	219	50.1	219.1	219.0	218.9
64	14.6	63.8	63.7	63.6	143	32.6	142.6	142.5	142.3	222	50.6	221.3	221.2	221.1
66	15.1	66.0	65.9	65.8	(12 ft) 145	33.1	144.8	144.6	144.5	224	51.1	223.5	223.4	223.3
68	15.6	68.2	68.1	68.0	147	33.6	147.0	146.8	146.7	226	51.6	225.7	225.6	225.5
70	16.1	70.4	70.3	70.2	149	34.1	149.1	149.0	148.9	(19 ft) 228	52.1	227.9	227.8	227.6
(6 ft) 73	16.6	72.6	72.5	72.3	152	34.6	151.3	151.2	151.1	230	52.6	230.1	230.0	229.8
75	17.1	74.8	74.7	74.5	154	35.1	153.5	153.4	153.3					
77	17.6	77.0	76.8	76.7	(13 ft) 156	35.6	155.7	155.6	155.5					
80	18.1	79.1	79.0	78.9	158	36.1	157.9	157.8	157.7					
81	18.6	81.3	81.2	81.1	160	36.6	160.1	160.0	159.8					
(7 ft) 84	19.1	83.5	83.4	83.3	162	37.1	162.3	162.1	162.0					

Note: all values are rounded to the nearest 0.1 inch

Endcap (No Connector) -NPF

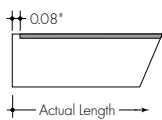

End Connector -IME

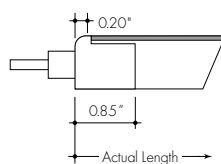

Back Connector -IMB

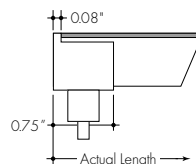

Side Connector -IMSA -IMSB

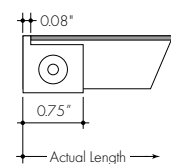

38SO | Power Consumption Per Fixture Length cont.

Based on operation with PDCU series of power supplies. Use Actual Length for Order Code Entry.
 Tolerance for Actual Lengths less than 6 ft is +/- 0.2", Actual Lengths between 6 ft and 16 ft is +/- 0.3", and Actual Lengths greater than 16 ft is +/- 0.6"
 A - End Connector at both ends of Kurba (0.20" + 0.20" added to overall length)
 B - End Connector at one end of Kurba and No Connector or Back Connector or Side Connector at other end of Kurba (0.20" + 0.08" added to overall length)
 C - Any combination of No Connector, Back Connector, or Side Connector on each end of Kurba (0.08" + 0.08" added to overall length)

Nominal Length (in)	Actual Length (in)				Nominal Length (in)	Actual Length (in)				Nominal Length (in)	Actual Length (in)			
	W	A	B	C		W	A	B	C		W	A	B	C
233	53.1	232.3	232.1	232.0	309	70.6	308.8	308.7	308.6	385	88.1	385.4	385.3	385.1
235	53.6	234.5	234.3	234.2	(26 ft) 311	71.1	311.0	310.9	310.8	388	88.6	387.6	387.5	387.3
237	54.1	236.6	236.5	236.4	313	71.6	313.2	313.1	313.0	390	89.1	389.8	389.6	389.5
(20 ft) 239	54.6	238.8	238.7	238.6	315	72.1	315.4	315.3	315.1	392	89.6	391.9	391.8	391.7
241	55.1	241.0	240.9	240.8	318	72.6	317.6	317.5	317.3	394	90.1	394.1	394.0	393.9
243	55.6	243.2	243.1	243.0	320	73.1	319.8	319.6	319.5	(33 ft) 396	90.6	396.3	396.2	396.1
246	56.1	245.4	245.3	245.1	322	73.6	321.9	321.8	321.7	399	91.1	398.5	398.4	398.3
248	56.6	247.6	247.5	247.3	(27 ft) 324	74.1	324.1	324.0	323.9	401	91.6	400.7	400.6	400.5
250	57.1	249.8	249.6	249.5	326	74.6	326.3	326.2	326.1	403	92.1	402.9	402.8	402.6
(21 ft) 252	57.6	252.0	251.8	251.7	329	75.1	328.5	328.4	328.3	405	92.6	405.1	404.9	404.8
254	58.1	254.1	254.0	253.9	331	75.6	330.7	330.6	330.5	(34 ft) 407	93.1	407.3	407.1	407.0
257	58.6	256.3	256.2	256.1	333	76.1	332.9	332.8	332.6	409	93.6	409.4	409.3	409.2
259	59.1	258.5	258.4	258.3	(28 ft) 335	76.6	335.1	335.0	334.8	412	94.1	411.6	411.5	411.4
261	59.6	260.7	260.6	260.5	337	77.1	337.3	337.1	337.0	414	94.6	413.8	413.7	413.6
(22 ft) 263	60.1	262.9	262.8	262.6	339	77.6	339.4	339.3	339.2	416	95.1	416.0	415.9	415.8
265	60.6	265.1	265.0	264.8	342	78.1	341.6	341.5	341.4	418	95.6	418.2	418.1	418.0
268	61.1	267.3	267.1	267.0	344	78.6	343.8	343.7	343.6	(35 ft) 420	96.1	420.4	420.3	420.1
270	61.6	269.5	269.3	269.2	346	79.1	346.0	345.9	345.8	423	96.6	422.6	422.4	422.3
272	62.1	271.6	271.5	271.4	(29 ft) 348	79.6	348.2	348.1	348.0	425	97.1	424.8	424.6	424.5
274	62.6	273.8	273.7	273.6	350	80.1	350.4	350.3	350.1	427	97.6	426.9	426.8	426.7
(23 ft) 276	63.1	276.0	275.9	275.8	353	80.6	352.6	352.5	352.3	429	98.1	429.1	429.0	428.9
279	63.6	278.2	278.1	278.0	355	81.1	354.8	354.6	354.5	431	98.6	431.3	431.2	431.1
281	64.1	280.4	280.3	280.1	357	81.6	356.9	356.8	356.7	(36 ft) 434	99.1	433.5	433.4	433.3
283	64.6	282.6	282.5	282.3	(30 ft) 359	82.1	359.1	359.0	358.9	Note: all values are rounded to the nearest 0.1 inch				
285	65.1	284.8	284.6	284.5	361	82.6	361.3	361.2	361.1					
(24 ft) 287	65.6	286.9	286.8	286.7	364	83.1	363.5	363.4	363.3					
289	66.1	289.1	289.0	288.9	366	83.6	365.7	365.6	365.5					
292	66.6	291.3	291.2	291.1	368	84.1	367.9	367.8	367.6					
294	67.1	293.5	293.4	293.3	370	84.6	370.1	370.0	369.8					
296	67.6	295.7	295.6	295.5	(31 ft) 372	85.1	372.3	372.1	372.0					
298	68.1	297.9	297.8	297.6	374	85.6	374.4	374.3	374.2					
(25 ft) 300	68.6	300.1	300.0	299.8	377	86.1	376.6	376.5	376.4					
302	69.1	302.3	302.1	302.0	379	86.6	378.8	378.7	378.6					
304	69.6	304.4	304.3	304.2	381	87.1	381.0	380.9	380.8					
307	70.1	306.6	306.5	306.4	(32 ft) 383	87.6	383.2	383.1	383.0					

Endcap (No Connector) -NPF

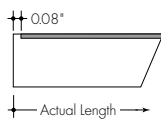

End Connector -IME

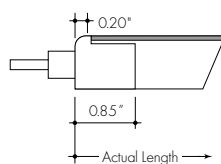

Back Connector -IMB

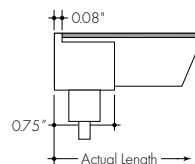

Side Connector -IMSA -IMSB

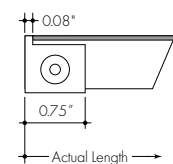

38HO Horizontal Bend | Power Consumption Per Fixture Length

Based on operation with PDCU series of power supplies. Use Actual Length for Order Code Entry.
 Tolerance for Actual Lengths less than 6 ft is +/- 0.2", Actual Lengths between 6 ft and 16 ft is +/- 0.3", and Actual Lengths greater than 16 ft is +/- 0.6"
 A - End Connector at both ends of Kurba (0.20" + 0.20" added to overall length)
 B - End Connector at one end of Kurba and No Connector or Back Connector or Side Connector at other end of Kurba (0.20" + 0.08" added to overall length)
 C - Any combination of No Connector, Back Connector, or Side Connector on each end of Kurba (0.08" + 0.08" added to overall length)

Nominal Length (in)	Actual Length (in)				Nominal Length (in)	Actual Length (in)				Nominal Length (in)	Actual Length (in)			
	W	A	B	C		W	A	B	C		W	A	B	C
7	2.7	7.0	6.8	6.7	86	32.7	85.7	85.6	85.5	165	62.7	164.5	164.3	164.2
9	3.5	9.1	9.0	8.9	88	33.5	87.9	87.8	87.7	167	63.5	166.6	166.5	166.4
(1 ft) 11	4.3	11.3	11.2	11.1	90	34.3	90.1	90.0	89.8	(14 ft) 169	64.3	168.8	168.7	168.6
14	5.2	13.5	13.4	13.3	92	35.2	92.3	92.2	92.0	171	65.2	171.0	170.9	170.8
16	6.0	15.7	15.6	15.5	95	36.0	94.5	94.3	94.2	173	66.0	173.2	173.1	173.0
18	6.8	17.9	17.8	17.7	(8 ft) 97	36.8	96.6	96.5	96.4	176	66.8	175.4	175.3	175.2
20	7.7	20.1	20.0	19.8	99	37.7	98.8	98.7	98.6	178	67.7	177.6	177.5	177.3
22	8.5	22.3	22.2	22.0	101	38.5	101.0	100.9	100.8	(15 ft) 180	68.5	179.8	179.6	179.5
(2 ft) 24	9.3	24.5	24.3	24.2	103	39.3	103.2	103.1	103.0	182	69.3	182.0	181.8	181.7
27	10.2	26.6	26.5	26.4	106	40.2	105.4	105.3	105.2	184	70.2	184.1	184.0	183.9
29	11.0	28.8	28.7	28.6	(9 ft) 108	41.0	107.6	107.5	107.3	187	71.0	186.3	186.2	186.1
31	11.8	31.0	30.9	30.8	110	41.8	109.8	109.7	109.5	189	71.8	188.5	188.4	188.3
33	12.7	33.2	33.1	33.0	112	42.7	112.0	111.8	111.7	(16 ft) 191	72.7	190.7	190.6	190.5
(3 ft) 35	13.5	35.4	35.3	35.2	114	43.5	114.1	114.0	113.9	193	73.5	192.9	192.8	192.7
38	14.3	37.6	37.5	37.3	116	44.3	116.3	116.2	116.1	195	74.3	195.1	195.0	194.8
40	15.2	39.8	39.7	39.5	119	45.2	118.5	118.4	118.3	198	75.2	197.3	197.1	197.0
42	16.0	42.0	41.8	41.7	(10 ft) 121	46.0	120.7	120.6	120.5	200	76.0	199.5	199.3	199.2
44	16.8	44.1	44.0	43.9	123	46.8	122.9	122.8	122.7	202	76.8	201.6	201.5	201.4
46	17.7	46.3	46.2	46.1	125	47.7	125.1	125.0	124.8	(17 ft) 204	77.7	203.8	203.7	203.6
(4 ft) 49	18.5	48.5	48.4	48.3	127	48.5	127.3	127.1	127.0	206	78.5	206.0	205.9	205.8
51	19.3	50.7	50.6	50.5	130	49.3	129.5	129.3	129.2	208	79.3	208.2	208.1	208.0
53	20.2	52.9	52.8	52.7	(11 ft) 132	50.2	131.6	131.5	131.4	211	80.2	210.4	210.3	210.2
55	21.0	55.1	55.0	54.8	134	51.0	133.8	133.7	133.6	213	81.0	212.6	212.5	212.3
57	21.8	57.3	57.2	57.0	136	51.8	136.0	135.9	135.8	(18 ft) 215	81.8	214.8	214.6	214.5
(5 ft) 60	22.7	59.5	59.3	59.2	138	52.7	138.2	138.1	138.0	217	82.7	217.0	216.8	216.7
62	23.5	61.6	61.5	61.4	141	53.5	140.4	140.3	140.2	219	83.5	219.1	219.0	218.9
64	24.3	63.8	63.7	63.6	143	54.3	142.6	142.5	142.3	222	84.3	221.3	221.2	221.1
66	25.2	66.0	65.9	65.8	(12 ft) 145	55.2	144.8	144.6	144.5	224	85.2	223.5	223.4	223.3
68	26.0	68.2	68.1	68.0	147	56.0	147.0	146.8	146.7	226	86.0	225.7	225.6	225.5
70	26.8	70.4	70.3	70.2	149	56.8	149.1	149.0	148.9	(19 ft) 228	86.8	227.9	227.8	227.6
(6 ft) 73	27.7	72.6	72.5	72.3	152	57.7	151.3	151.2	151.1					
75	28.5	74.8	74.7	74.5	154	58.5	153.5	153.4	153.3					
77	29.3	77.0	76.8	76.7	(13 ft) 156	59.3	155.7	155.6	155.5					
80	30.2	79.1	79.0	78.9	158	60.2	157.9	157.8	157.7					
81	31.0	81.3	81.2	81.1	160	61.0	160.1	160.0	159.8					
(7 ft) 84	31.8	83.5	83.4	83.3	162	61.8	162.3	162.1	162.0					

Note: all values are rounded to the nearest 0.1 inch

Endcap (No Connector) -NPF

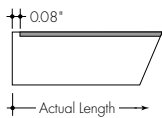

End Connector -IME

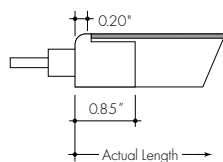

Back Connector -IMB

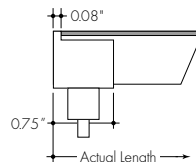

Side Connector -IMSA -IMSB

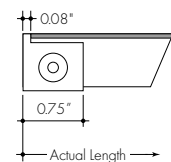

38MO | Power Consumption Per Fixture Length

Based on operation with PDCU series of power supplies. Use Actual Length for Order Code Entry.
 Tolerance for Actual Lengths less than 6 ft is +/- 0.2", Actual Lengths between 6 ft and 16 ft is +/- 0.3", and Actual Lengths greater than 16 ft is +/- 0.6"
 A - End Connector at both ends of Kurba (0.20" + 0.20" added to overall length)
 B - End Connector at one end of Kurba and No Connector or Back Connector or Side Connector at other end of Kurba (0.20" + 0.08" added to overall length)
 C - Any combination of No Connector, Back Connector, or Side Connector on each end of Kurba (0.08" + 0.08" added to overall length)

Nominal Length (in)	Actual Length (in)				Nominal Length (in)	Actual Length (in)				Nominal Length (in)	Actual Length (in)				Nominal Length (in)	Actual Length (in)			
	W	A	B	C		W	A	B	C		W	A	B	C		W	A	B	C
7	2.1	7.0	6.8	6.7	86	26.1	85.7	85.6	85.5	165	50.1	164.5	164.3	164.2	243	74.1	243.2	243.1	243.0
9	2.8	9.1	9.0	8.9	88	26.8	87.9	87.8	87.7	167	50.8	166.6	166.5	166.4	246	74.8	245.4	245.3	245.1
(1 ft) 11	3.5	11.3	11.2	11.1	90	27.5	90.1	90.0	89.8	(14 ft) 169	51.5	168.8	168.7	168.6	248	75.5	247.6	247.5	247.3
14	4.1	13.5	13.4	13.3	92	28.1	92.3	92.2	92.0	171	52.1	171.0	170.9	170.8	250	76.1	249.8	249.6	249.5
16	4.8	15.7	15.6	15.5	95	28.8	94.5	94.3	94.2	173	52.8	173.2	173.1	173.0	(21 ft) 252	76.8	252.0	251.8	251.7
18	5.5	17.9	17.8	17.7	(8 ft) 97	29.5	96.6	96.5	96.4	176	53.5	175.4	175.3	175.2	254	77.5	254.1	254.0	253.9
20	6.1	20.1	20.0	19.8	99	30.1	98.8	98.7	98.6	178	54.1	177.6	177.5	177.3	257	78.1	256.3	256.2	256.1
22	6.8	22.3	22.2	22.0	101	30.8	101.0	100.9	100.8	(15 ft) 180	54.8	179.8	179.6	179.5	259	78.8	258.5	258.4	258.3
(2 ft) 24	7.5	24.5	24.3	24.2	103	31.5	103.2	103.1	103.0	182	55.5	182.0	181.8	181.7	261	79.5	260.7	260.6	260.5
27	8.1	26.6	26.5	26.4	106	32.1	105.4	105.3	105.2	184	56.1	184.1	184.0	183.9	(22 ft) 263	80.1	262.9	262.8	262.6
29	8.8	28.8	28.7	28.6	(9 ft) 108	32.8	107.6	107.5	107.3	187	56.8	186.3	186.2	186.1	265	80.8	265.1	265.0	264.8
31	9.5	31.0	30.9	30.8	110	33.5	109.8	109.7	109.5	189	57.5	188.5	188.4	188.3	268	81.5	267.3	267.1	267.0
33	10.1	33.2	33.1	33.0	112	34.1	112.0	111.8	111.7	(16 ft) 191	58.1	190.7	190.6	190.5	270	82.1	269.5	269.3	269.2
(3 ft) 35	10.8	35.4	35.3	35.2	114	34.8	114.1	114.0	113.9	193	58.8	192.9	192.8	192.7	272	82.8	271.6	271.5	271.4
38	11.5	37.6	37.5	37.3	116	35.5	116.3	116.2	116.1	195	59.5	195.1	195.0	194.8	274	83.5	273.8	273.7	273.6
40	12.1	39.8	39.7	39.5	119	36.1	118.5	118.4	118.3	198	60.1	197.3	197.1	197.0	(23 ft) 276	84.2	276.0	275.9	275.8
42	12.8	42.0	41.8	41.7	(10 ft) 121	36.8	120.7	120.6	120.5	200	60.8	199.5	199.3	199.2	279	84.8	278.2	278.1	278.0
44	13.5	44.1	44.0	43.9	123	37.5	122.9	122.8	122.7	202	61.5	201.6	201.5	201.4	281	85.5	280.4	280.3	280.1
46	14.1	46.3	46.2	46.1	125	38.1	125.1	125.0	124.8	(17 ft) 204	62.1	203.8	203.7	203.6	283	86.2	282.6	282.5	282.3
(4 ft) 49	14.8	48.5	48.4	48.3	127	38.8	127.3	127.1	127.0	206	62.8	206.0	205.9	205.8	285	86.8	284.8	284.6	284.5
51	15.5	50.7	50.6	50.5	130	39.5	129.5	129.3	129.2	208	63.5	208.2	208.1	208.0	(24 ft) 287	87.5	286.9	286.8	286.7
53	16.1	52.9	52.8	52.7	(11 ft) 132	40.1	131.6	131.5	131.4	211	64.1	210.4	210.3	210.2	289	88.2	289.1	289.0	288.9
55	16.8	55.1	55.0	54.8	134	40.8	133.8	133.7	133.6	213	64.8	212.6	212.5	212.3	292	88.8	291.3	291.2	291.1
57	17.5	57.3	57.2	57.0	136	41.5	136.0	135.9	135.8	(18 ft) 215	65.5	214.8	214.6	214.5	294	89.5	293.5	293.4	293.3
(5 ft) 60	18.1	59.5	59.3	59.2	138	42.1	138.2	138.1	138.0	217	66.1	217.0	216.8	216.7	296	90.2	295.7	295.6	295.5
62	18.8	61.6	61.5	61.4	141	42.8	140.4	140.3	140.2	219	66.8	219.1	219.0	218.9	298	90.8	297.9	297.8	297.6
64	19.5	63.8	63.7	63.6	143	43.5	142.6	142.5	142.3	222	67.5	221.3	221.2	221.1	(25 ft) 300	91.5	300.1	300.0	299.8
66	20.1	66.0	65.9	65.8	(12 ft) 145	44.1	144.8	144.6	144.5	224	68.1	223.5	223.4	223.3	302	92.2	302.3	302.1	302.0
68	20.8	68.2	68.1	68.0	147	44.8	147.0	146.8	146.7	226	68.8	225.7	225.6	225.5	304	92.8	304.4	304.3	304.2
70	21.5	70.4	70.3	70.2	149	45.5	149.1	149.0	148.9	(19 ft) 228	69.5	227.9	227.8	227.6	307	93.5	306.6	306.5	306.4
(6 ft) 73	22.1	72.6	72.5	72.3	152	46.1	151.3	151.2	151.1	230	70.1	230.1	230.0	229.8	309	94.2	308.8	308.7	308.6
75	22.8	74.8	74.7	74.5	154	46.8	153.5	153.4	153.3	233	70.8	232.3	232.1	232.0	(26 ft) 311	94.8	311.0	310.9	310.8
77	23.5	77.0	76.8	76.7	(13 ft) 156	47.5	155.7	155.6	155.5	235	71.5	234.5	234.3	234.2					
80	24.1	79.1	79.0	78.9	158	48.1	157.9	157.8	157.7	237	72.1	236.6	236.5	236.4					
81	24.8	81.3	81.2	81.1	160	48.8	160.1	160.0	159.8	(20 ft) 239	72.8	238.8	238.7	238.6					
(7 ft) 84	25.5	83.5	83.4	83.3	162	49.5	162.3	162.1	162.0	241	73.5	241.0	240.9	240.8					

Note: all values are rounded to the nearest 0.1 inch

Endcap (No Connector) -NPF

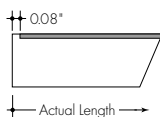

End Connector -IME

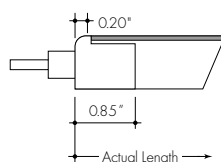

Back Connector -IMB

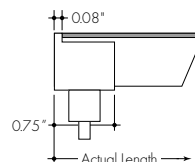

Side Connector -IMSA -IMSB

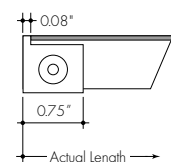

Power Supplies

See Power Supply instructions and spec sheet for wiring information. For a complete list of compatible dimmers, see Compatible Dimming Chart on the Resources page.

Universal Power Supply 1% 120VAC - 277VAC

MODEL	POWER	OUTPUT
PDCU-D - IP20 Dry Series	30 - 30 W 60 - 60 W 96 - 96 W 3X96 - 3X96 W	24 - 24 VDC
PDCU-W - IP66 Wet Series	96 - 96 W 3X96 - 3X96 W	

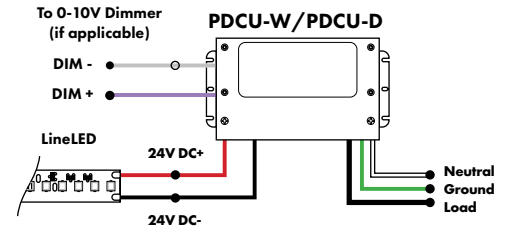

0-10V dims down to 1%, MLV/ELV/TRIAC dims down to 1%.
For a complete list of compatible dimmers, see [Compatible Dimming Chart](#) on the Resources page.

MODELS	PDCU-W 96W	PDCU-W 3X96W	PDCU-D 30W	PDCU-D 60W	PDCU-D 96W	PDCU-D 3X96W
Length	8.66"	11.85"	6.10"	7.93"	8.25"	9.57"
Width	3.73"	4.32"	3.35"	3.35"	4.10"	5.94"
Depth	1.61"	1.81"	1.33"	1.32"	1.56"	1.13"

0-10V Dimming Power Supplies 0.1% 120VAC - 277VAC

MODEL	POWER	OUTPUT	DIMMING
PS010V - 0-10V Power Supply dims down to 0.1%	96 - 96 Watt 3X96 - 3 X 96 Watt	24 - 24 VDC	LIN - Linear LOG - Logarithmic

MODELS	96W	3X96
Length	14.40"	15.75"
Width	5.20"	6.62"
Depth	2.60"	4.95"

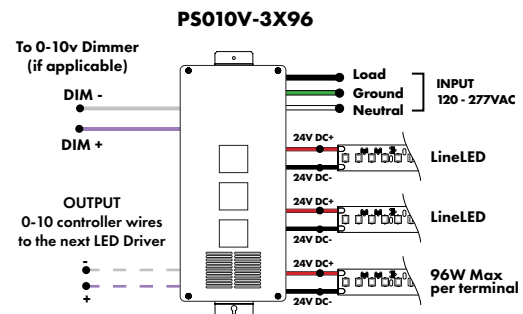
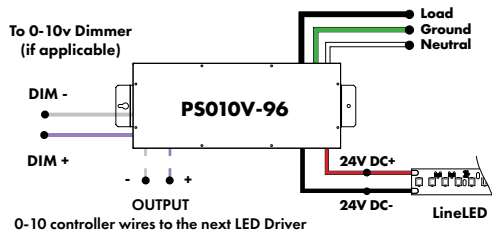

Power Supplies

See Power Supply instructions and spec sheet for wiring information. For a complete list of compatible dimmers, see Compatible Dimming Chart on the Resources page.

DMX Dimming Power Supplies 120VAC - 277VAC

MODEL	POWER	OUTPUT
PSDMX - DMX Power Supply dims down to 0%	96 - 96 Watt 3X96 - 3 X 96 Watt	24 - 24 VDC

Features eldoLED's LINEARdrive configurable dimmable drivers

MODELS	96W	3X96
Length	14.40"	15.75"
Width	5.20"	6.62"
Depth	2.60"	4.95"

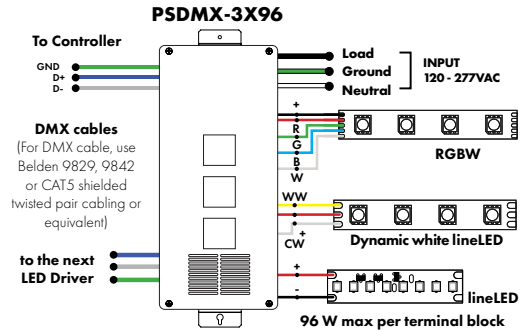
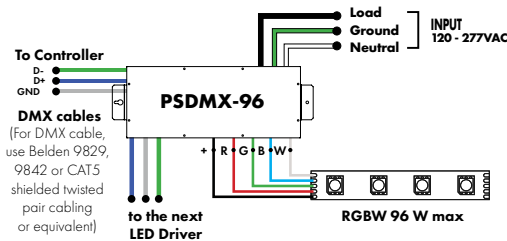

DALI 0% Dimming Power Supplies 120VAC - 277VAC

MODEL	POWER	OUTPUT
PSDALI - DALI Power Supply dims down to 0%	96 - 96 Watt 3X96 - 3 X 96 Watt	24 - 24 VDC

Features eldoLED's LINEARdrive configurable dimmable drivers

Model	96W	3X96
Length	14.40"	15.75"
Width	5.20"	6.62"
Depth	2.60"	4.95"

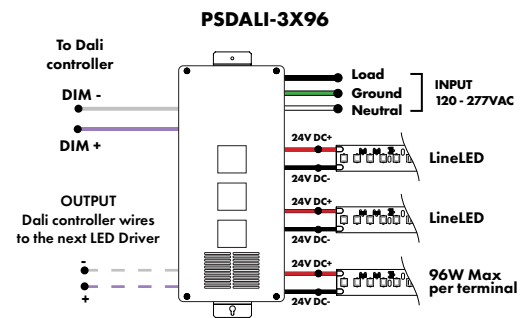
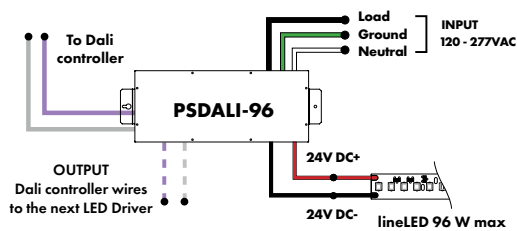

Enlighted Enabled Dimming Power Supplies 120VAC - 277VAC

MODEL	POWER	OUTPUT	DIMMING	LOCATION
PSV - PSV Series	96 - 96 Watt	24 - 24 VDC	ENL - Enlighted Dimming dims down to 0%	D - Damp

Model	96W
Length	14.40"
Width	5.20"
Depth	2.60"

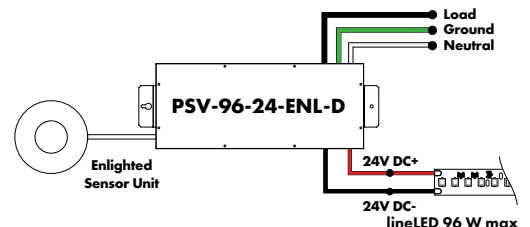

Power Supplies

See Power Supply instructions and spec sheet for wiring information. For a complete list of compatible dimmers, see Compatible Dimming Chart on the Resources page.

Non-Dimming Power Supply 120VAC - 277VAC

MODEL	POWER	OUTPUT	DIMMING	LOCATION
PSV - PSV Series	96 - 96 Watt	24 - 24 VDC	ND - Non Dimming	D - Damp

MODELS	96W
Length	14.40"
Width	5.20"
Depth	2.60"

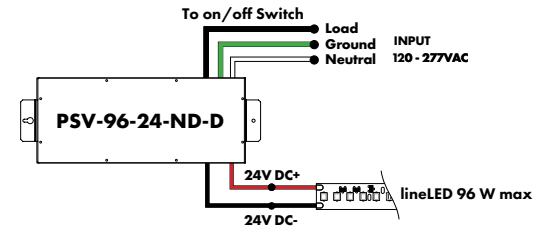

Luminii is a Lutron OEM Advantage Partner

Lutron Power Supplies 1%

MODEL
L3DA4U1UKL-CV240

HiLume™ 1% EcoSystem Voltage LED driver
40W max

MODELS	L3DA4U1UKL-CV240
Length	4.98"
Width	4.00"
Depth	2.62"

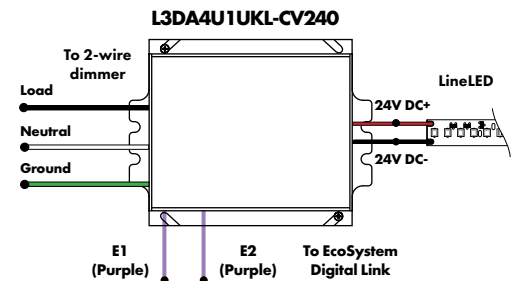

Luminii is a Lutron OEM Advantage Partner

Lutron Power Supplies 0.1%

MODEL
L3D0-96W24V-U

HiLume™ 0.1% EcoSystem Voltage LED Driver with Soft-On, Fade-to-Black™
96W max

MODELS	L3D0
Length	10.50"
Width	5.50"
Depth	2.00"

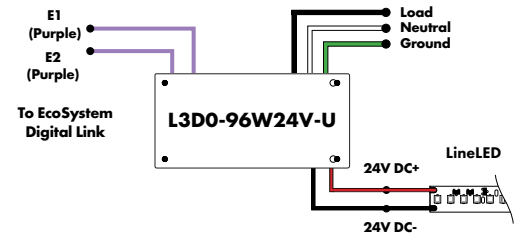

In-Ground Power Supplies

MODEL	POWER	OUTPUT	INPUT
IG - In ground CVE Series CVE - ELV Dimming DALI - eldoLED Dali dimming Both dims down to 0%	96X2 - 2 X 96 Watt	24 - 24 VDC	Blank - 120 V 277 - 240/277 V

MODELS	Dual Circuit
Length	8.40"
Width	8.30"
Depth	8.10"

