

Katana - Low Profile Linear LED Lighting. The Katana is a simple extrusion with a low profile, creating options for lighting effects in unique locations without sacrificing functionality.

Ordering Code

Fixture	555	815					
	1	2	3	4	5	6	7

Product Specifications

SAMPLE : Fixture 555 - 815 - 500 - LO - 27 - E36 - 6'

1 - Type		2 - Model		3 - Lens		4 - LED Style*1		
555 · Profile		815 · Katana		500 · Frosted 502 · Clear 509 · High Frosted		Static White L01W · LLHE48LO-1W 1 Watt LO · LLHE48LO Low Output SO · LLHE48SO Standard Output MO · LLHE48MO Medium Output Dynamic Color*2 DWSO · LLDW68SO Dynamic White Standard Output DWHO · LLDW68HO Dynamic White High Output RGBSO · LLRGB42SO Color changing Standard Output RGBWSO · LL-RGBW36-SO Color changing Standard Output		
5 - CCT		6 - Feed Length		7 - Fixture Length*1				
Static White 22 · 2200K 25 · 2500K 27 · 2700K 30 · 3000K 35 · 3500K 40 · 4000K		Dynamic Color*2 1935 · 1900K - 3500K*3 98 · RGB Color changing 99 · RGB+W Color changing		B36 · 36" Back Fed E36 · 36" End Fed BXX · Custom Back Fed EXX · Custom End Fed		XX · Custom (XX.XX") <i>Continuous runs will be made in equal sections no more than 8' long</i> NOTE: For Channels and Lenses over 90°, incremental shipping charges will apply		*1 Refer to page 2 for LED cut length intervals and available CCT *2 DMX driver required *3 Please ask about different CCT ranges Project : _____ Quantity : _____ Type : _____ Notes : _____

LED Technical Information

	STYLE	WATT/FT	DELIVERED LM/FT CLEAR	DELIVERED LM/FT FROSTED	DELIVERED LM/FT HIGHT FROSTED	CRI	MAX. LENGTH	Color TEMPERATURE
Static White	LLHE48LO-1W	1.0	126	89	91	92	60'	2200K, 2500K, 2700K, 3000K, 3500K, 4000K
	LLHE48LO	1.9	253	179	182	92	48'	
	LLHE48SO	2.8	361	255	260	92	42'	
	LLHE48MO	3.5	482	341	347	92	33'	
Dynamic Color	LLDW68SO-1935	4.1	428	303	309	95	32'	1900K - 3500K
	LLDW68HO-1935	5.2	466	329	336	96	32'	
	LLRGB42SO	4.4	210	149	152	---	28'	Red/Green/Blue
	LLRGBW36SO	4.1	217	153	156	97	26'	Red/Green/Blue White LED 97 CRI / 3000K

* Lumen output calculations based on 3500K.
For LED strip information, See the page for:

LLHE48 [HERE](#).
LLDW68 [HERE](#).
LLRGB42 [HERE](#).
LLRGBW36 [HERE](#).

Lens/Light Distribution

part number **500** (frosted 65% transparent)
502 (clear 95% transparent)
509 (frosted 65% transparent)

- PMMA construction
- Easily clipped in profile
- Comes precut to match profile length
- Flush

Clear Lens

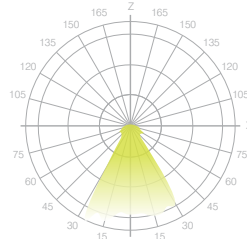

Frosted Lens

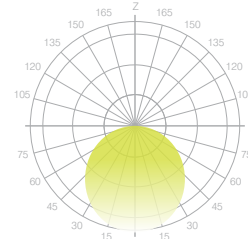

High Frosted Lens

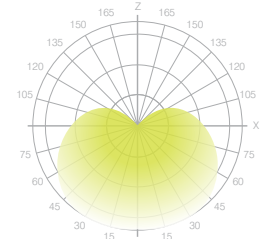

Construction

- Housing: Aluminum extrusion
- Made in Canada

Installation

- Factory assembled for easy and fast installation
- Electrical wire included

Dimensions

Clear / Frosted

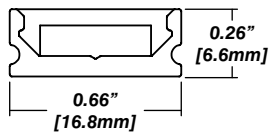

High Frosted

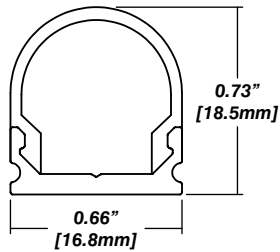

Joining Sections

- Typical 2" jumper on runs over 8'

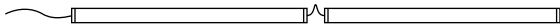

45° Mount Clip

part number **555-815-21**

- Steel construction
- Profile is mounted flush to surface
- Not visible once installed

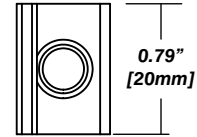
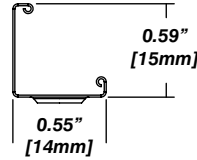

Flush Mount Clip

part number **555-815-20**

- Steel construction
- Profile is mounted flush to surface
- Not visible once installed

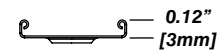
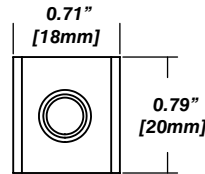
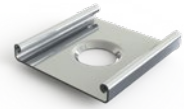

Universal Power Supply 1% 120VAC - 277VAC

Universal Power Supply 1% 120VAC - 277VAC

MODEL	POWER	OUTPUT
PDCU-D - IP20 Dry Series	30 - 30 W 60 - 60 W 96 - 96 W	24 - 24 VDC

PDCU-W - IP66 Wet Series 96 - 96 W

0-10V dims down to 1%, MLV/ELV/TRIAC dims down to 1%.
Contact Senso to specify 347V transformer.
For a complete details on the Universal Power Supply, see Spec Sheet, Compatible Dimming and Install Guide on the [Resources page](#).

MODELS	PDCU-W 96W	PDCU-D 30W	PDCU-D 60W	PDCU-D 96W
Length	8.66"	6.10"	7.93"	8.25"
Width	3.73"	3.35"	3.35"	4.10"
Depth	1.61"	1.33"	1.32"	1.56"

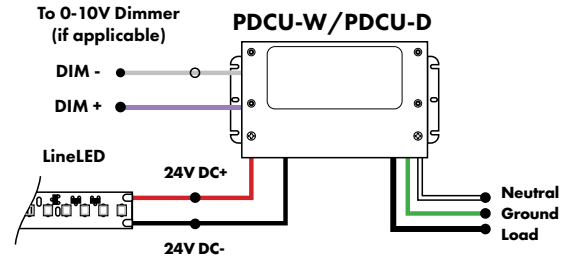

30W/60W 347V Transformer
attaches directly to PDCU box

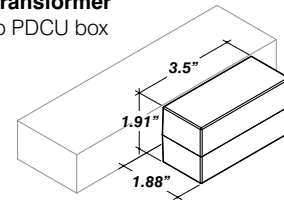

96W 347V Transformer
wired to PDCU box

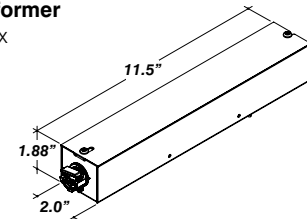

DMX Dimming Power Supply 120VAC - 277VAC

DMX Dimming Power Supplies 120VAC - 277VAC

MODEL	POWER	OUTPUT
PSDMX - DMX Power Supply dims down to 0%	96 - 96 Watt 3X96 - 3 X 96 Watt	24 - 24 VDC

Features eldoLED's LINEARdrive configurable dimmable drivers. For a complete details on the DMX Dimming Power Supply, see Spec Sheet on the [Resources page](#).

MODELS	96W	3X96
Length	14.40"	15.75"
Width	5.20"	6.62"
Depth	2.60"	4.95"

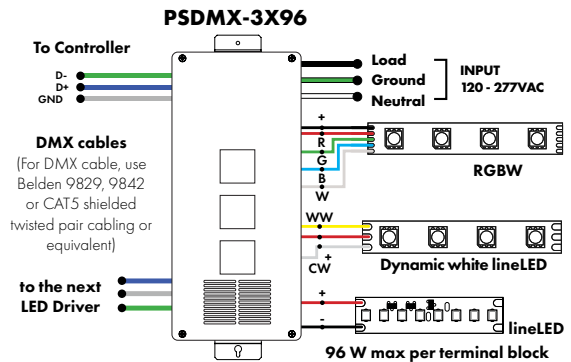
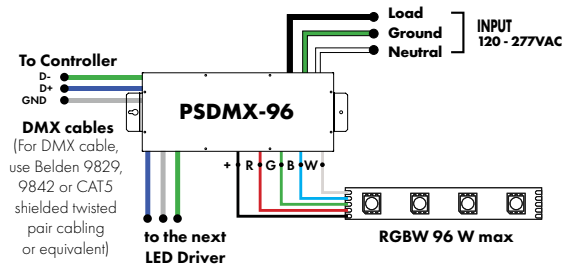

DALI 0% Dimming Power Supplies 120VAC - 277VAC

DALI 0% Dimming Power Supplies 120VAC - 277VAC

MODEL	POWER	OUTPUT
PSDALI - DALI Power Supply dims down to 0%	96 - 96 Watt 3X96 - 3 X 96 Watt	24 - 24 VDC

Features eldoLED's LINEARdrive configurable dimmable drivers

Model	96W	3X96
Length	14.40"	15.75"
Width	5.20"	6.62"
Depth	2.60"	4.95"

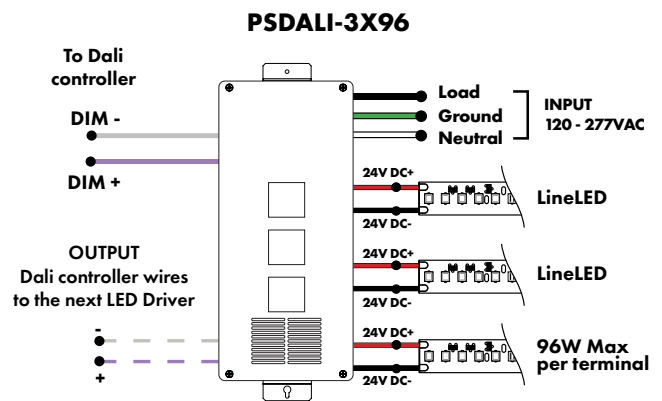
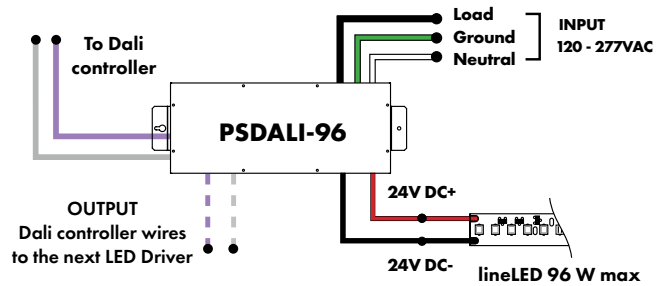

LUTRON®

Luminii is a Lutron OEM Advantage Partner
Lutron Power Supplies 1%

MODEL

LTEA4U1UKL - CV240

Lutron - Hi-lume™ 1% 2-wire LED Driver
40W max

(120V forward phase only)

MODEL

L3DA4U1UKL - CV240

Hi-lume™ 1% EcoSystem Voltage LED driver
40W max

MODELS	LTEA4U1UKL-CV240	L3DA4U1UKL-CV240
Length	4.89"	4.98"
Width	4.00"	4.00"
Depth	2.62"	2.62"

For a complete details on the Lutron Power Supply, see Spec Sheet and Install Guide on the [Resources page](#).

LUTRON®

Luminii is a Lutron OEM Advantage Partner
Lutron Power Supplies 0.1%

MODEL

L3D0-96W24V-U

Hi-lume™ 0.1% EcoSystem Voltage LED Driver with Soft-On, Fade-to-Black™
96W max

MODELS	L3D0
Length	10.50"
Width	5.50"
Depth	2.00"

