

Hero adjustable luminaire with LightShift technology allows for 40 degree tilt and 360 degree pan beam adjustment without moving or rotating the luminaire body. Harmonious integration into the architecture and flexible installation into the tightest spaces. Fixed light emitting face orientation, precision optics, adaptive glare baffle, and advanced anti-reflective materials provide for exceedingly low glare. Available with a wide range of beam characteristics, shapes, colors, and mounting configurations. Hero Recessed easily directs light where its needed without breaking a sweat, or the plane of the ceiling.

Mounting	Non-IC new construction	Dimming	Phase 1%, 0-10V 1%/0.1%, or DALI 0.1%
Shape	Rounded or rectangular	Beam Angle	11°, 14°, 23°, 36°, 44°
Hanger Length	14" to 24" standard, Up to 48" optional	Location	Dry and Damp
Ceiling Thickness	Trimless: 1/4" - 2", low-profile trim: 1/2" - 5/8"	Lifetime	60,000 hours
Operating Power	120-277 V, 50-60 Hz, power factor > 0.9	Warranty	5 years

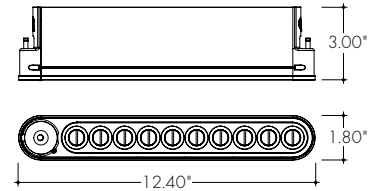

Technical Information

MODEL:	Hero	
Light Output (3000K)	SO	1290 lm
Efficacy	58 lm/W	
Color Temperature	2700K, 3000K, 3500K, 4000K	
CRI	92	
Wattage	SO	23W
Beam Tilt	Rated to ±40 deg	
Beam Pan	Infinite (360 Deg with no stops)	

CCT	Lumens	CRI		TM-30		CBCP				
		R _a	R _g	R _f	R _g	LS11	LS14	LS23	LS36	LS44
2700K	1220	92	65	89	103	27712	18379	7206	3212	2375
3000K	1290	96	79	94	101	29252	19400	7606	3390	2507
3500K	1335	95	81	94	102	30330	20115	7886	3515	2599
4000K	1390	94	74	92	99	32724	21703	8509	3792	2805

*HO multiplier = 1.2x

Name	BEAM				
	LS11	LS14	LS23	LS36	LS44
Width (Diameter)	11°	14°	23°	36°	44°
Field Angle	20°	25°	38°	59°	69°

Ordering Code

Fixture

MODEL	TYPE	SHAPE	CCT	OPTIC	FINISH
HER10-Hero Adjustable 10 LED ¹	RC-Recessed Mount	RD-Rounded Endcaps SQ-Squared Endcaps ²	27K-2700K 30K-3000K 35K-3500K 40K-4000K	LS11-11 Degree LightShift LS14-14 Degree LightShift LS23-23 Degree LightShift LS36-36 Degree LightShift LS44-44 Degree LightShift	BK-Black

Housing

HOUSING TYPE	MODEL	SHAPE	OUTPUT	TRIM & FINISH	INSTALL OPTIONS	DRIVER
HNC-NonIC New Const	HER10-Hero 10 LED	RD-Rounded Endcaps SQ-Squared Endcaps (MF ONLY)	SO-Standard Output	TW-Trim White TB-Trim Black TL-Mud Flange	NA-None BFB-Butterfly Brackets CBH-48" Commercial Bar Hangers Not for Type NR	PHSD-Forward/Reverse Phase, 1% Dim, 120V/277V O10S-0-10V, 1% Dim, 120/277 O10L-eldolED, 0-10V, linear, 0.1% Dim O10G-eldolED, 0-10V, Log, 0.1% Dim DALI-eldolED, Dali Protocol 2, DT-6, 0.1% Dim

1. Fixture must be ordered with a housing.
2. SQ Not available for Trimmed Install.

Product Dimensions

Trimless

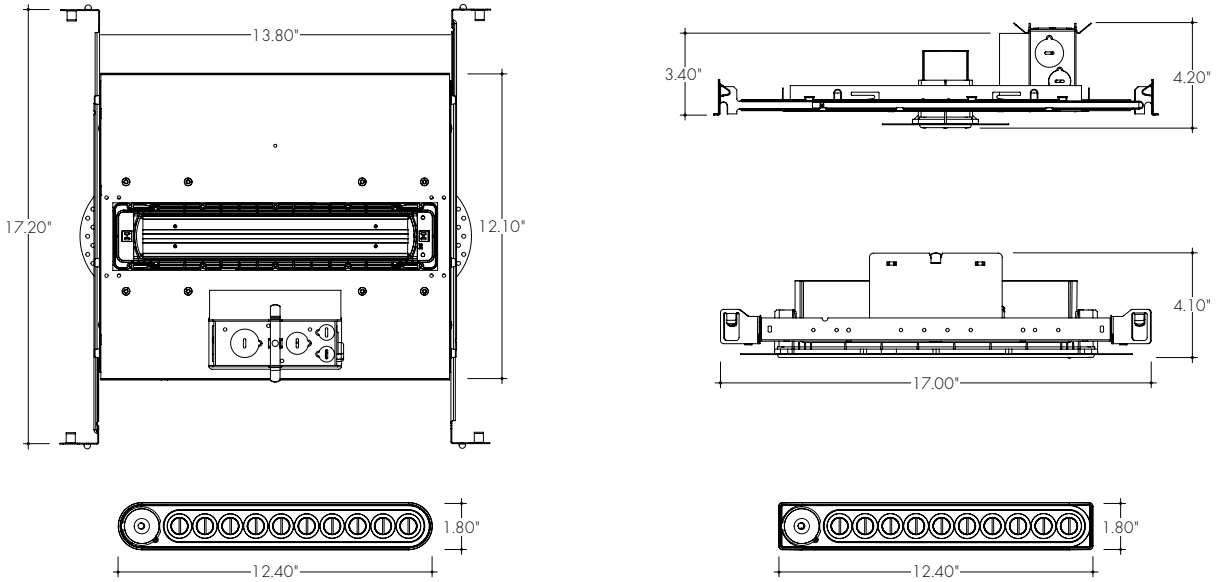

Trim

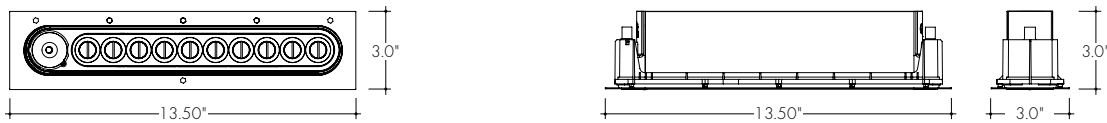

Shape

RD
Rounded Endcaps



SQ
Squared Endcaps



Trim Finish

TB
Trim Black



TW
Trim White

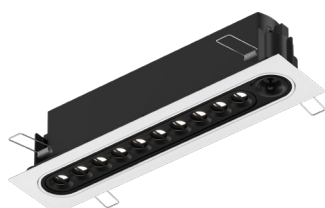

TL
Trimless mud-in



Photometry

A-Downlight



B-30 Degree Beam Adjustment

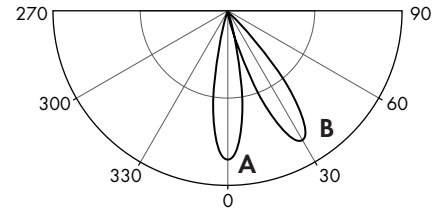

*Beam steering achieved with intuitive joystick movement.

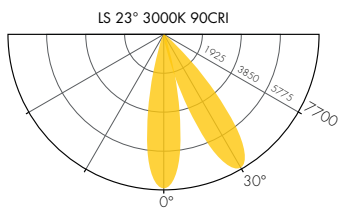
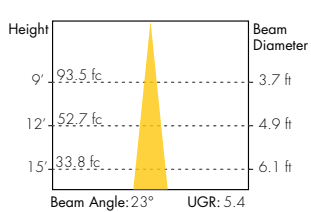
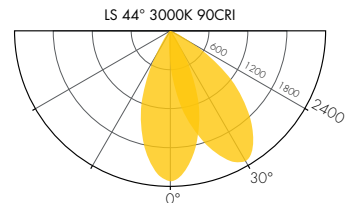
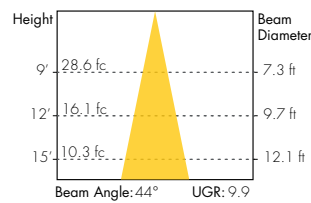
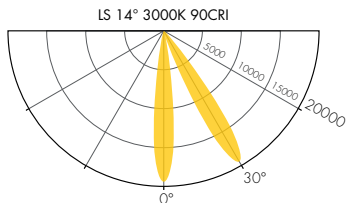
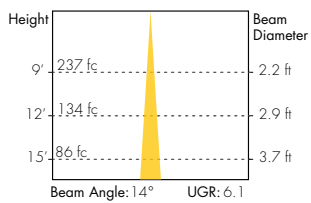
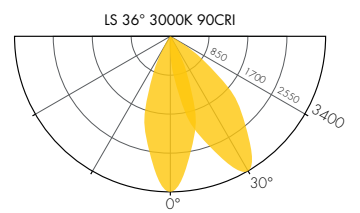
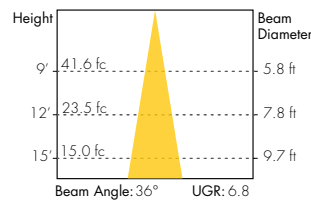
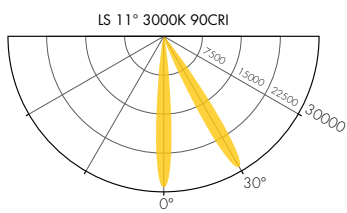
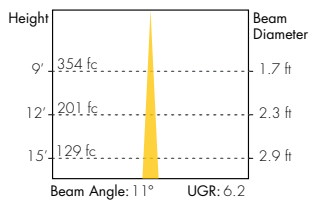

Family

