

RECESSED TRIMMED & TRIMLESS



DRX5 is a compact recessed luminaire that masters the art of pin spotting and accent lighting while combining excellent beam quality with all the benefits of RCL technology. The DRX5 is available with three fixed CCT light engines, delivering up to 1,474 lumens from a wide selection of fixed beam options as well as zoom powered by Lensvector. DRX5 is also available with Tunable White and RGBW - visit their specsheets to learn more.

KEY FEATURES

- 360° pan with 35° tilt Motorised Movement
- Wired or Wireless control
- Position and light level scene recall
- Fully recessed and does not break the ceiling line
- Premium componentry
- Available with IC rated housing for North America

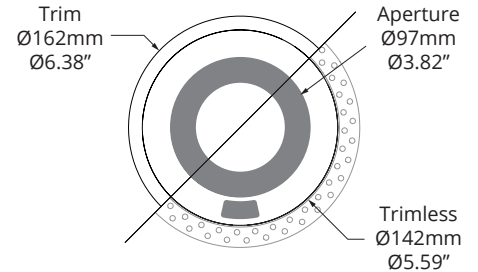

PERFORMANCE DATA

OUTPUT OPTIONS	500LM		600LM		1400LM			
BEAM OPTIONS	4°		6°	5-55° Zoom ¹	10°	22°	34°	10-55° Zoom ¹
DELIVERED OUTPUT	540 lm		628 lm	478 lm ¹	1,474 lm	1,399 lm	1,304 lm	1,309 lm ¹
PEAK INTENSITY	56,646 cd		41,409 cd	39,527 cd ¹	41,654 cd	8,931 cd	3,739 cd	33,214 cd ¹
LED ARRANGEMENT	Multi source		Single source		Single source			
LED WATTAGE	10 W		11 W		17 W			
EFFICACY	54 lm/W		57 lm/W		87 lm/W			
DYNAMIC WATTAGE	16.5 W ²		17.8 W ²		25.3 W ²			
CCT OPTIONS	2700K 3000K 4000K		2700K 3000K 4000K		2700K 3000K 4000K			

Notes

¹ Value at narrowest zoom setting

² Dynamic Wattage is the total power draw momentarily possible when both motors are running simultaneously.

MECHANICAL & MOUNTING

LOCATION	IP20	LIFETIME	L90 50,000 hrs min
ADJUSTABILITY	360° Pan, 35° Tilt	WARRANTY	5 Years
WEIGHT	1.55kg / 3.42lb IC housing +5.3kg / 11.68lb	TM65	67.90kgCO ₂ e
MATERIAL	Machined AL 6063-T6	TM66	2.4
POWER SUPPLY	Remote	ACCESSORIES	Separate holder - Louver Lenses
MOUNTING	Recessed		

ORDER CODE

MODEL	MOUNTING	CCT	OUTPUT	BEAM ANGLE	TYPE	CONTROL	FINISH
DRX5 DRX5	TR Trimmed	27K 2700K	05 500LM	PN Pinspot 4°	230 230V 50/60Hz UNICP 120-277V Chicago Plenum IC Housing	HAND Controller Only ¹	WH White
	TL Trimless	30K 3000K				010V 0-10V ²	BK Black
		40K 4000K	06 600LM	UN Ultra Narrow 6° ZO Zoom 5-55°		DALI DALI ³ DMX DMX RCLC RCL Control	
			14 1400LM	NA Narrow 10° ME Medium 22° WD Wide 34° ZO Zoom 10-55°			

Notes

¹ Handheld controller only, no additional control option enabled

² 0-10V controls light level only, handheld remote used for movement and scene control

³ DALI controls light level, groups and scenes, handheld remote used for movement

DRX5

RECESSED TRIMMED & TRIMLESS

DRX5 TRIMMED



White



Black

DRX5 TRIMLESS



White



Black

DRX5

RECESSED TRIMMED & TRIMLESS

INSTALLATION CLEARANCE AND ARTICULATION

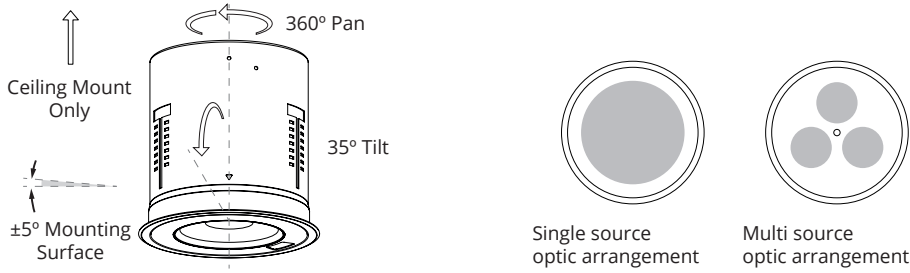

DRX5 TRIMMED

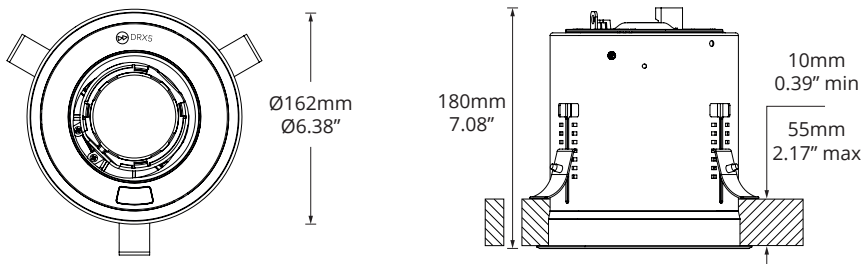

DRX5 TRIMLESS

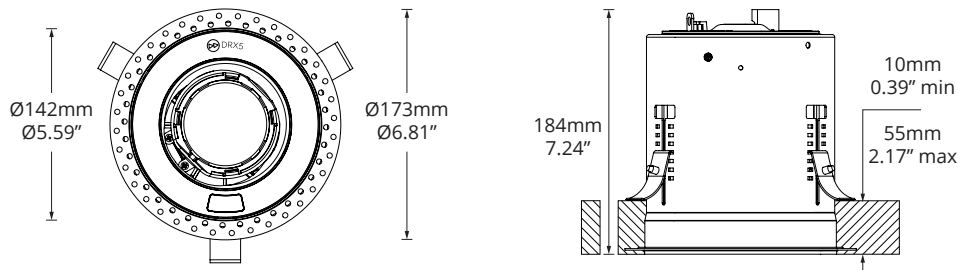

120V / 277V IC HOUSING FOR NORTH AMERICA

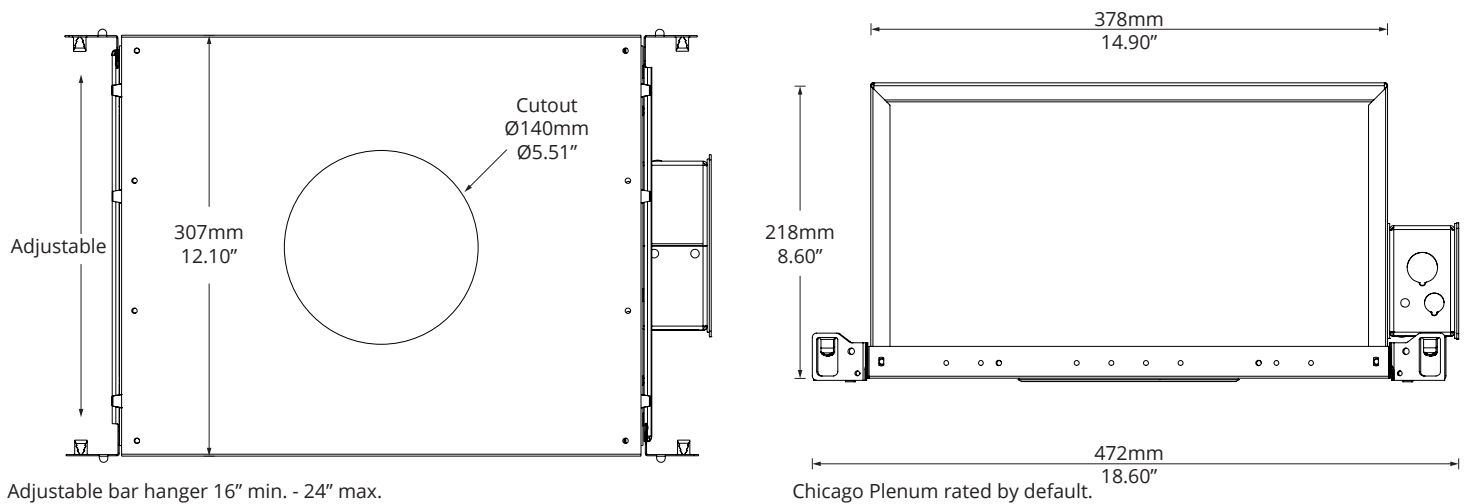

DIMMING & CONTROL TABLE

	Core Control Option In all products	Additional Control Option 1 can be used in addition to the handheld remote Remote required for commissioning			
	Handheld Remote	RCL Control	DALI	DMX	0-10V
BRIGHTNESS	✓	✓	✓	✓	✓
MOVEMENT	✓	✓	1	✓	
COLOUR TEMPERATURE	✓	✓	✓	✓	
RGBW	✓	✓	1	✓2	
ZOOM	✓	✓	1	✓	
SCENES	✓	✓	1	✓	

1. Zoom, RGBW and position programmed by handheld remote, recalled by DALI scenes command. 10 scenes available, not available with all DALI systems.
 2. Hue and Saturation control.

DIMMING & CONTROL DETAILS

Handheld Remote

The RCL handheld remote controller affords control of all aspects of the luminaire. Our products are available both as solely controlled by the remote or with another protocol. Regardless of if another protocol is specified on the product, it will always have the ability to be controlled by our handheld remote controller. The luminaire will always power up with its last configuration.

RCL Control

The RCL Control iPad app offers an intuitive, user-friendly interface capable of managing multiple rooms and floors. RCL control requires a mediator device that acts as the wired to wireless interface on the project, this device acts as the hub, receiving then distributing wireless commands to up to 200 luminaires. The mediator can receive DALI or DMX wired inputs to allow control of groups of luminaires and recalling scenes requested from external building management systems. RCL Control utilises a dynamic wireless mesh network for robust, scalable and low-latency performance, ensuring reliable and secure operation without internet dependence. Luminaires can be organised into zones, groups and scenes, all controlled through our award-winning reflected ceiling plan interface.

DALI

DALI offers brightness, CCT, group and scene control of our luminaires, the handheld remote is needed for movement. The first 10 scenes can be programmed by handheld controller and recalled by DALI, in this case all configured features can be set and recalled (i.e. zoom, position, etc). Not all DALI controllers use the DALI scene command, so testing is recommended.

DMX

All configured features of our luminaires are available for control by DMX, by default the fixture will have a footprint of 4, allowing for pan, tilt and dim control. The handheld remote allows the user to select one of six possible profiles allowing for dim only, dim and movement or movement and control of all fitted light engine features with different resolutions available. Please note that RGBW is controlled with a hue and saturation channel. When installing DMX to track mounted fixtures it is important to ensure that appropriate electrical isolation is provided between the DMX circuits on the track and any DMX connections. The DMX and electrical grounds will need to be connected, typically by a mains-powered splitter on the same circuit.

0-10V

0-10V has a single control group as all luminaires connected to the databus will dim in unison. 0-10V will only control the brightness, the handheld remote is needed for movement, CCT and zoom if available.

Phase

Phase dimming is not available on RCL products.

Control method not listed here? We have a wealth of experience integrating with 3rd party control systems so get in touch.

500LM LIGHT ENGINE - OUTPUT SCALING

CCT	Multiplier	CRI	R9	Rf	Rg	Max Delivered lm
2400K	-	-	-	-	-	N/A
2700K	0.92	90	53	89	99	497lm
3000K	1.00	90	53	89	99	540lm
3500K	-	-	-	-	-	N/A
4000K	1.30	80	50	79	98	702lm

All diagrams and data measured at 3000K

500LM LIGHT ENGINE - PHOTOMETRY

4° BEAM

BEAM ANGLE 4°
DELIVERED LM 540lm
PEAK INTENSITY 56656cd

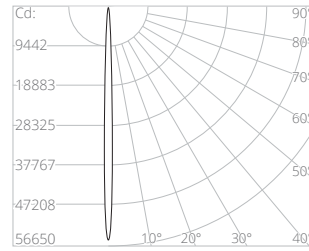

Height	Beam Diameter	Peak Intensity (lx)	Footcandle (fc)	Beam Diameter (ft)
1m	0.07m	56646lx	6294fc	0.2ft
2m	0.14m	14162lx	1574fc	0.4ft
3m	0.21m	6294lx	699fc	0.6ft
4m	0.28m	3540lx	393fc	0.8ft
5m	0.35m	2266lx	252fc	1.0ft
			175fc	1.3ft

600LM LIGHT ENGINE - OUTPUT SCALING

CCT	Multiplier	CRI	R9	Rf	Rg	Max Delivered lm
2400K	-	-	-	-	-	N/A
2700K	0.93	90	54	90	99	584lm
3000K	1.00	90	54	90	99	628lm
3500K	-	-	-	-	-	N/A
4000K	1.00	90	53	90	98	628lm

All diagrams and data measured at 3000K

600LM LIGHT ENGINE - PHOTOMETRY

6° BEAM

BEAM ANGLE 6°
 DELIVERED LM 628lm
 PEAK INTENSITY 41409cd

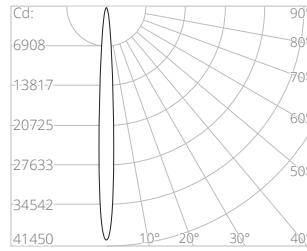

Distance	Beam Diameter	Peak Intensity (lx)	Beam Diameter (ft)	Peak Intensity (fc)
1m	0.10m	41409lx	0.3ft	4601fc
2m	0.21m	10352lx	0.6ft	1150fc
3m	0.31m	4601lx	0.9ft	511fc
4m	0.42m	2588lx	1.3ft	288fc
5m	0.52m	1656lx	1.6ft	184fc

ZOOM 5° NARROWEST BEAM

BEAM ANGLE 5°
 DELIVERED LM 473lm
 PEAK INTENSITY 39527cd

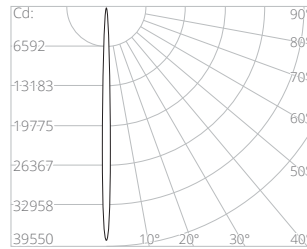

Distance	Beam Diameter	Peak Intensity (lx)	Beam Diameter (ft)	Peak Intensity (fc)
1m	0.09m	39527lx	0.3ft	4392fc
2m	0.17m	9882lx	0.5ft	1098fc
3m	0.26m	4392lx	0.8ft	488fc
4m	0.35m	2470lx	1.0ft	274fc
5m	0.44m	1581lx	1.3ft	176fc

ZOOM 55° NARROWEST BEAM

BEAM ANGLE 55°
 DELIVERED LM 478lm
 PEAK INTENSITY 481cd

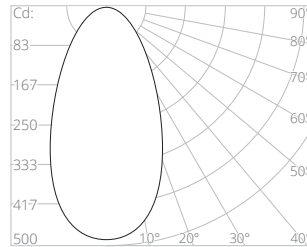
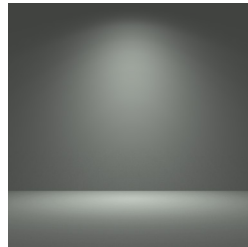

Distance	Beam Diameter	Peak Intensity (lx)	Beam Diameter (ft)	Peak Intensity (fc)
1m	1.04m	481lx	3.1ft	53fc
2m	2.08m	120lx	6.2ft	13fc
3m	3.12m	53lx	9.4ft	6fc
4m	4.16m	30lx	12.5ft	3fc
5m	5.21m	19lx	15.6ft	2fc

1400LM LIGHT ENGINE - OUTPUT SCALING

CCT	Multiplier	CRI	R9	Rf	Rg	Max Delivered lm
2400K	-	-	-	-	-	N/A
2700K	1.00	92	50	90	99	1474lm
3000K	1.00	92	50	90	99	1474lm
3500K	-	-	-	-	-	N/A
4000K	1.15	92	50	90	98	1695lm

All diagrams and data measured at 3000K

1400LM LIGHT ENGINE - PHOTOMETRY

10° BEAM

BEAM ANGLE 10°
 DELIVERED LM 1474lm
 PEAK INTENSITY 41654cd

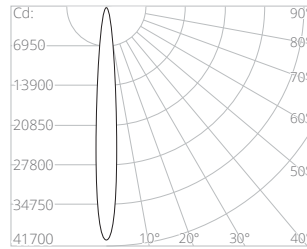

Distance	Beam Diameter	Peak Intensity (lx)	Footcandle (fc)	Height (ft)
1m	0.17m	41654lx	4628fc	0.5ft
2m	0.35m	10414lx	1157fc	1.0ft
3m	0.52m	4628lx	514fc	1.6ft
4m	0.70m	2603lx	289fc	2.1ft
5m	0.87m	1666lx	185fc	2.6ft

22° BEAM

BEAM ANGLE 22°
 DELIVERED LM 1399lm
 PEAK INTENSITY 8931cd

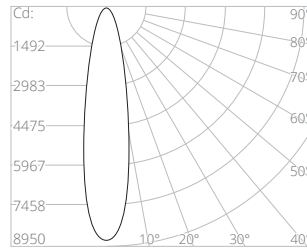

Distance	Beam Diameter	Peak Intensity (lx)	Footcandle (fc)	Height (ft)
1m	0.39m	8931lx	992fc	1.2ft
2m	0.78m	2233lx	248fc	2.3ft
3m	1.17m	992lx	110fc	3.5ft
4m	1.56m	558lx	62fc	4.7ft
5m	1.94m	357lx	40fc	5.8ft

34° BEAM

BEAM ANGLE 34°
 DELIVERED LM 1304lm
 PEAK INTENSITY 3739cd

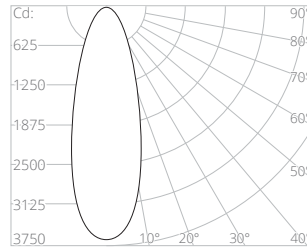
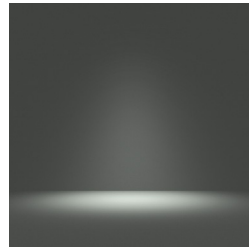

Distance	Beam Diameter	Peak Intensity (lx)	Footcandle (fc)	Height (ft)
1m	0.61m	3739lx	415fc	1.8ft
2m	1.22m	935lx	104fc	3.7ft
3m	1.83m	415lx	46fc	5.5ft
4m	2.45m	234lx	26fc	7.3ft
5m	3.06m	150lx	17fc	9.2ft

ZOOM 10° NARROWEST BEAM

BEAM ANGLE 10°
 DELIVERED LM 1309lm
 PEAK INTENSITY 33214cd

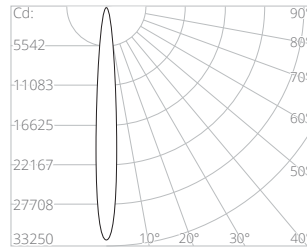

Distance	Beam Diameter	Peak Intensity (lx)	Footcandle (fc)	Height (ft)
1m	0.17m	33214lx	3690fc	0.5ft
2m	0.35m	8304lx	923fc	1.0ft
3m	0.52m	3690lx	410fc	1.6ft
4m	0.70m	2076lx	231fc	2.1ft
5m	0.87m	1329lx	148fc	2.6ft

ZOOM 55° WIDEST BEAM

BEAM ANGLE 55°
 DELIVERED LM 986lm
 PEAK INTENSITY 991cd

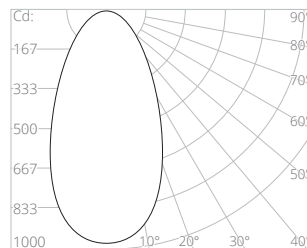
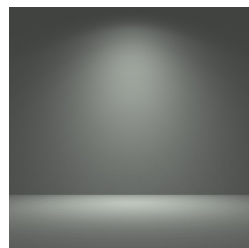

Distance	Beam Diameter	Peak Intensity (lx)	Footcandle (fc)	Height (ft)
1m	1.04m	991lx	110fc	3.1ft
2m	2.08m	248lx	28fc	6.2ft
3m	3.12m	110lx	12fc	9.4ft
4m	4.16m	62lx	7fc	12.5ft
5m	5.21m	40lx	4fc	15.6ft

ACCESSORIES

Accessories for 600lm / 1400lm fixed beam angle

A separate accessory holder is required that is field swappable. This can accommodate a louver plus 1 lens.

Accessories for 600lm / 1400lm zoom

No additional holder is required, accessories are factory fitted if ordered.

ACCESSORIES ORDER CODE

	500lm 4°	600lm / 1400lm Fixed beam angle	600lm / 1400lm Zoom	Use
ORDER CODES				
ACCESSORY HOLDER	-	18259	No holder required	Accommodates 1 louver plus 1 lens
HONEYCOMB LOUVER	-	18241	18882	Reduces field beam and glare
NARROW MICROLENS	-	18302	18302	Light beam softening
MEDIUM MICROLENS	-	18303	18303	Medium beam softening
WIDE MICROLENS	-	18304	18304	Heavy beam softening

FEATURE MAP

