

INDOOR IP68 & IK10 RATED

TRIDENT Recessed

RECESSED LINEAR PROFILE



Trident Indoor - Recessed IP68 & IK10 Rated Linear Profile. The Trident Indoor Recessed is designed for applications requiring sturdy, seamless in-floor or IP68 & IK10 rated lighting. Our LED encapsulation process ensures a long lasting, vandal resistant seal with hard resin. Configuration and layout possibilities are endless making it highly versatile and easy to install.

Ordering Code

Fixture **455** **406**

1 2 3 4 5 6 7 8

Product Specifications

SAMPLE : Fixture 455 - 406 - FH - LO - 27 - 02 - E36 - 6'

1 - Type	2 - Model	3 - Resin	4 - LED Style ^{*1}	
455 · IP68 & IK10 Rated Profile	406 · Trident Recessed Indoor	FS · Frosted Soft CS · Clear Soft FH · Frosted Hard CH · Clear Hard	Static White LO · LLHE48LO Low Output SO · LLHE48SO Standard Output MO · LLHE48MO Medium Output HO · LLHE48HO High Output	Dynamic Color ^{*2} DWSO · LLDW68SO Dynamic White Standard Output DWHO · LLDW68HO Dynamic White High Output RGBSO · LLRGB42SO Color changing Standard Output RGBHO · LLRGB42HO Color changing High Output RGBWSO · LL-RGBW36-SO Color changing Standard Output RGBWHO · LL-RGBW36-HO Color changing High Output
5 - CCT	6 - Finish		7 - Feed Length	8 - Fixture Length ^{*1}
Static White 25 · 2500K 27 · 2700K 30 · 3000K 35 · 3500K 40 · 4000K	Dynamic Color ^{*2} 1935 · 1900K - 3500K ^{*4} 98 · RGB Color changing 99 · RGB+W Color changing		02 · Black ^{*3} 08 · Silver B36 · 36" Back Fed E36 · 36" End Fed BXX · Custom Back Fed EXX · Custom End Fed	XX · Custom (XX.XX") <i>Continuous runs will be made in equal sections no more than 8' long</i> NOTE: For Channels and Lenses over 90°, incremental shipping charges will apply

^{*1} Refer to page 2 for LED cut length intervals and available CCT
^{*2} DMX driver required
^{*3} Only Trident extrusion and mounting blocks finished in anodized black
^{*4} Please ask about different CCT ranges

Project : _____
Quantity : _____
Type : _____
Notes : _____

TRIDENT Recessed

RECESSED LINEAR PROFILE

LED Technical Information

	STYLE	WATT/FT	DELIVERED LM/FT CLEAR	DELIVERED LM/FT FROSTED	CRI	MAX. LENGTH	Color TEMPERATURE
Static White	LLHE48LO-1W	1.0	80	51	92	60'	2200K, 2500K, 2700K, 3000K, 3500K, 4000K
	LLHE48LO	1.9	160	102	92	48'	
	LLHE48SO	2.8	228	146	92	42'	
	LLHE48MO	3.5	304	195	92	33'	
	LLHE48HO	7.3	488	313	90	21'	
Dynamic Color	LLDW68SO-1935	4.1	251	186	95	32'	1900K - 3500K
	LLDW68HO-1935	5.2	273	202	96	32'	
	LLRGB42SO	4.4	149	81	---	28'	Red/Green/Blue
	LLRGB42HO	7.7	231	126	---	28'	
	LLRGBW36SO	4.1	127	94	97	26'	Red/Green/Blue White LED 97 CRI / 3000K
	LLRGBW36HO	7.6	281	153	97	26'	

* Lumen output calculations based on 3500K.
For LED strip information, See the page for:

LLHE48 [HERE](#).
LLDW68 [HERE](#).
LLRGB42 [HERE](#).
LLRGBW36 [HERE](#)

TRIDENT Recessed

RECESSED LINEAR PROFILE

Resin & Profile Features

Top Layer

The top resin layer of the Trident acts as the lens and first line of defense for the LED.

Soft cured resin:

Outdoor resistant against rain, snow and direct sunlight as well as intense conditions like hail and acid rain. The resin is also thermal resistant against thermal cycles and drastic changes in temperature.

Chemicals like detergents or disinfectants will not deteriorate, disintegrate or discolor the soft resin.

Hard cured resin:

The hard cured resin maintains all of the same outdoor resistant features as the soft, but acquires extra physical resistance as well. Abrasion resistance will keep the resin intact even after wear, impact or high levels of pressure are applied. It will prevent vandalism and resist fire and ignition. The hard resin allows any profile to be floor mounted.

Fill Layer

The fill layer of the IP68 & IK10 rated Trident main purpose is to fully encapsulate and protect the LED strip. This fully sealed layer is able to maintain light quality without any color shift. The fill layer will not yellow over time and will keep perfect CRI and color-consistency over the lifespan of the LED.

Aluminum Extrusion

Trident, along with all our profile fixtures, are made of anodized aluminum. This allows our profile to be as thin as possible while maintaining rigidity and limiting flex over long runs.

Recessed Features

The recessed channels grooves allows linking multiple sections together. The trident profile slots straight into the top of the recessed channel and sits flush with any surface when installed. The main gap of the recessed channel provides ample space for long runs of cable and guarantees expansion and future proofing. The dedicated bottom space promotes drainage down and away from wiring.

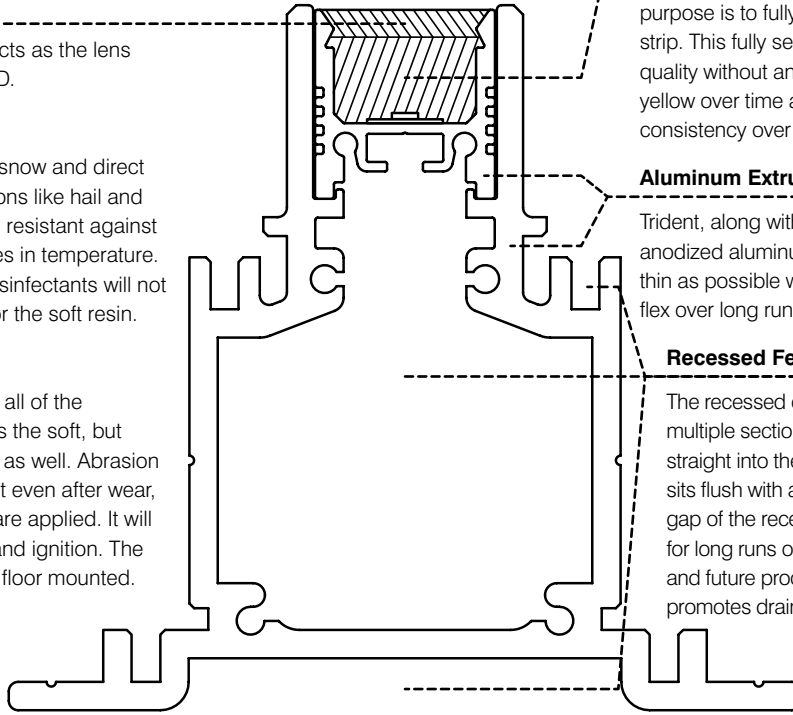

Top Layer Finish

Frosted Resin

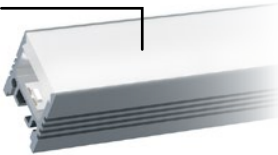

The frosted resin top layer is available in both hard and soft options. It offers a soft diffused light with no dots.

Clear Resin

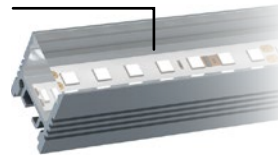

The clear resin top layer is the best option for maximum light efficiency. Low light loss allows you to get the most out of each LED.

TRIDENT Recessed

RECESSED LINEAR PROFILE

Construction

- High quality poured resin lens
- Hard, clear and frosted resin options
- Aluminum extruded profile and recessed channel

Installation

- Electrical wire included
- Recessed channel connects to L-bracket and end caps with seamless corners and straight runs
- Includes plastic spacer for laying floor material

Dimensions

Recessed Channel with Trident

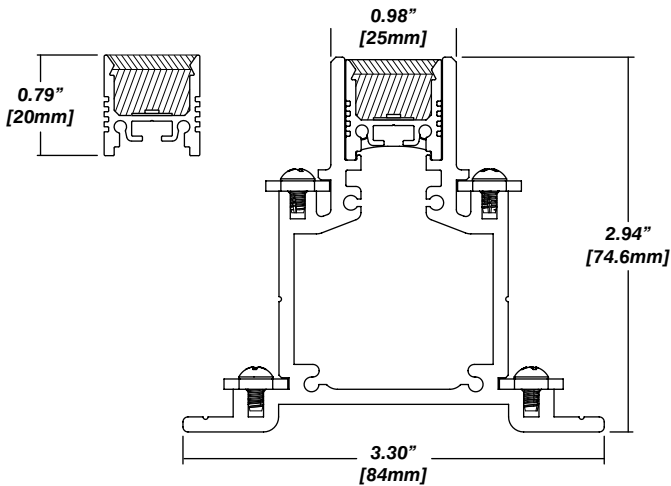

Recessed Channel

- Solid aluminum extruded construction
- Trident drops straight in to channel
- Allows Trident to be recessed into many different materials

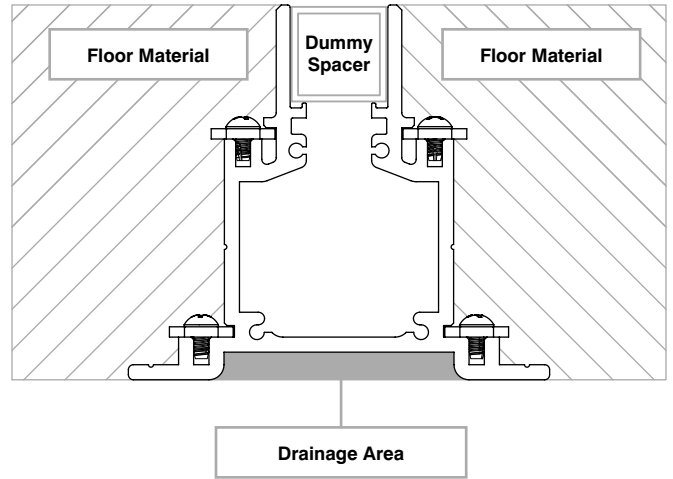
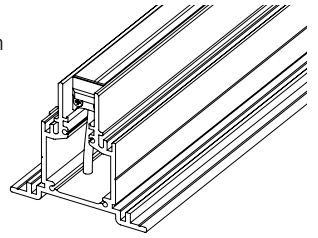

Feed Points & Joining Sections

Back Fed

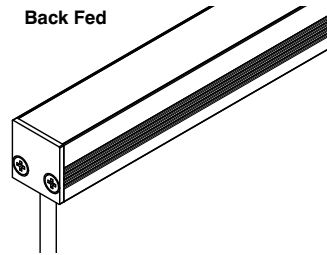

- Multiple profile with separate back feed

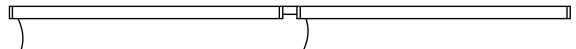

TRIDENT Recessed

RECESSED LINEAR PROFILE

End Cap

- Holds Trident in place at each end of the channel
- End cap may have hole drilled out to be end fed

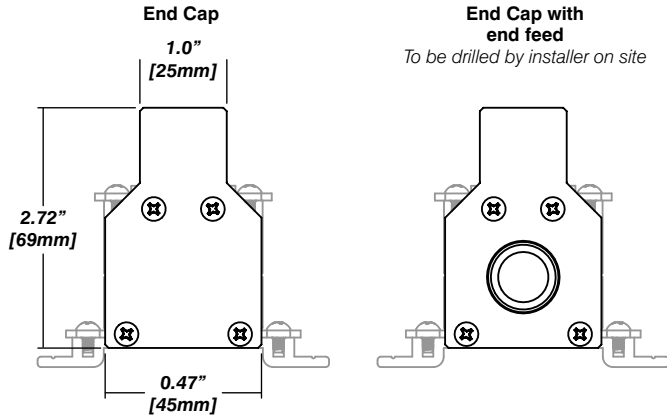

Channel Brackets

- Securely connects 2 channel sections together
- Held in place by 2 screws per channel section
- 4 brackets required per join (2 per side)

Straight Adapter

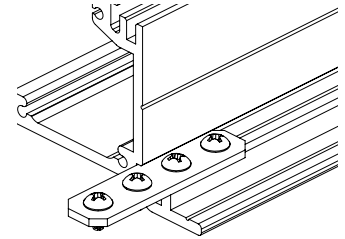
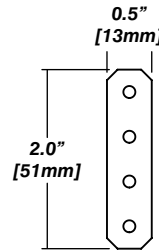

Corner Adapter

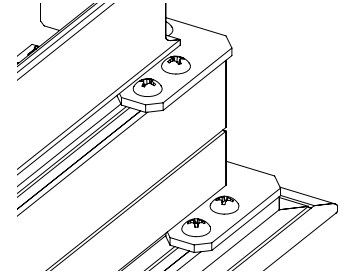
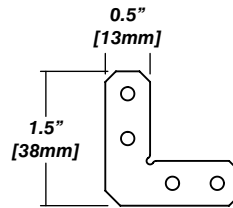

INDOOR IP68 & IK10 RATED

TRIDENT Recessed

RECESSED LINEAR PROFILE

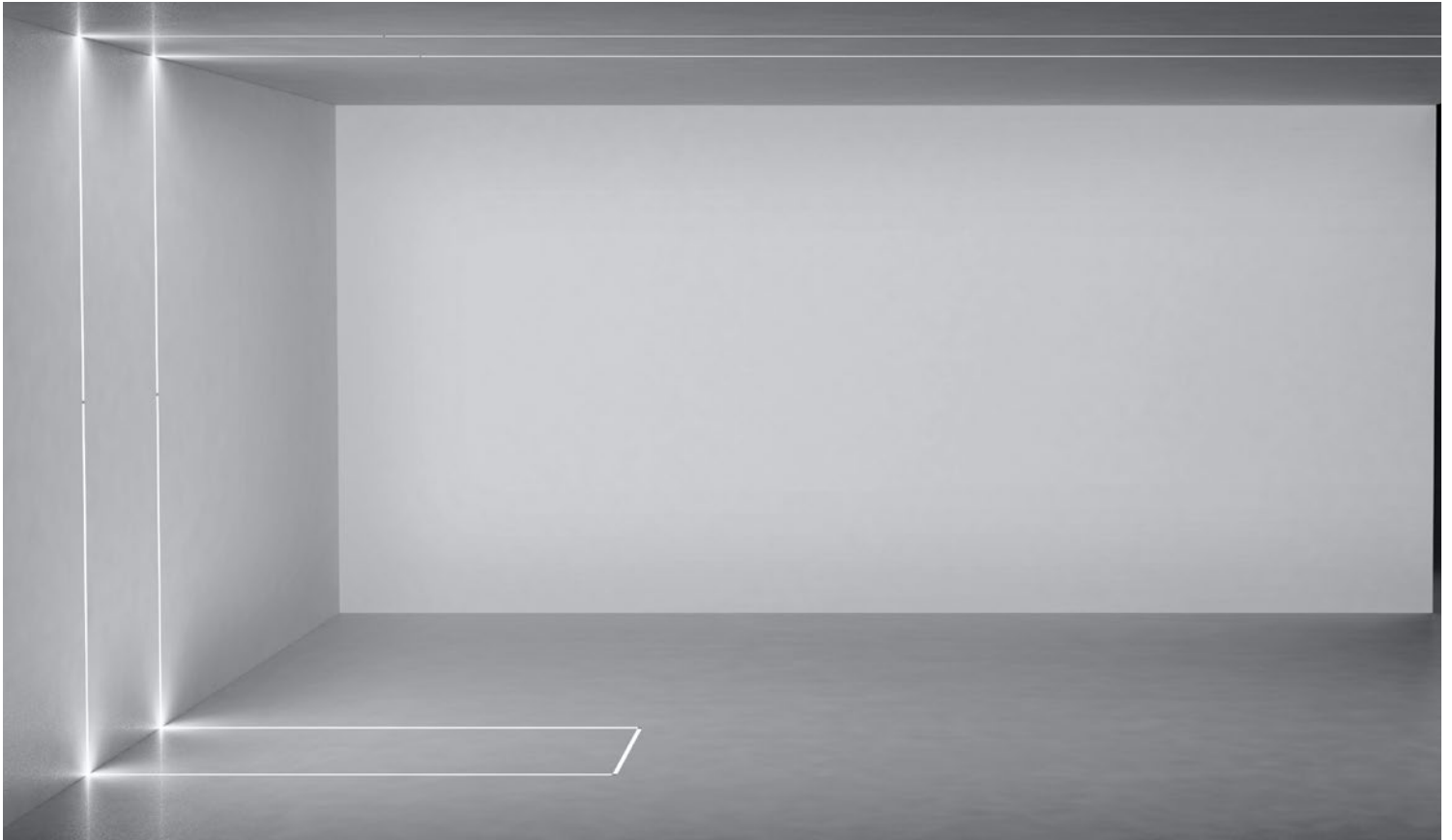

Recessed System (Indoor Shown)

Recessed lighting promotes the best integration of lighting and architecture. Creativity is the only limitation because Trident recessed can flow seamlessly through a space linking surfaces in a solid beam.

TRIDENT Recessed

RECESSED LINEAR PROFILE

Universal Power Supply 1% 120VAC - 277VAC

Universal Power Supply 1% 120VAC - 277VAC

MODEL	POWER	OUTPUT
PDCU-D - IP20 Dry Series	30 - 30 W 60 - 60 W 96 - 96 W	24 - 24 VDC

PDCU-W - IP66 Wet Series 96 - 96 W

0-10V dims down to 1%, MLV/ELV/TRIAC dims down to 1%.
Contact Senso to specify 347V transformer.
For a complete details on the Universal Power Supply, see Spec Sheet, Compatible Dimming and Install Guide on the [Resources page](#).

MODELS	PDCU-W 96W	PDCU-D 30W	PDCU-D 60W	PDCU-D 96W
Length	8.66"	6.10"	7.93"	8.25"
Width	3.73"	3.35"	3.35"	4.10"
Depth	1.61"	1.33"	1.32"	1.56"

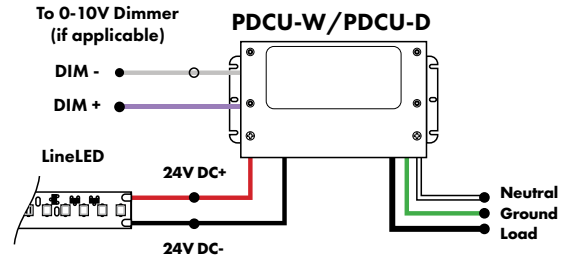

30W/60W 347V Transformer
attaches directly to PDCU box

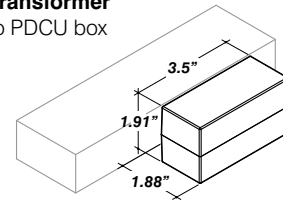

96W 347V Transformer
wired to PDCU box

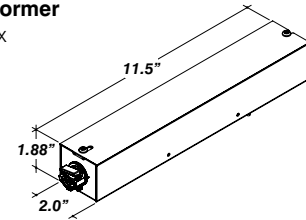

DMX Dimming Power Supply 120VAC - 277VAC

DMX Dimming Power Supplies 120VAC - 277VAC

MODEL	POWER	OUTPUT
PSDMX - DMX Power Supply dims down to 0%	96 - 96 Watt 3X96 - 3 X 96 Watt	24 - 24 VDC

Features eldoLED's LINEARdrive configurable dimmable drivers. For a complete details on the DMX Dimming Power Supply, see Spec Sheet on the [Resources page](#).

MODELS	96W	3X96
Length	14.40"	15.75"
Width	5.20"	6.62"
Depth	2.60"	4.95"

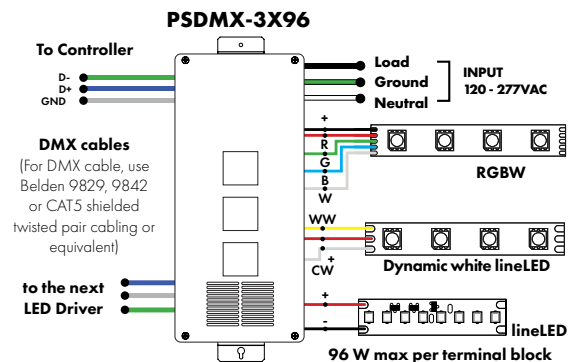
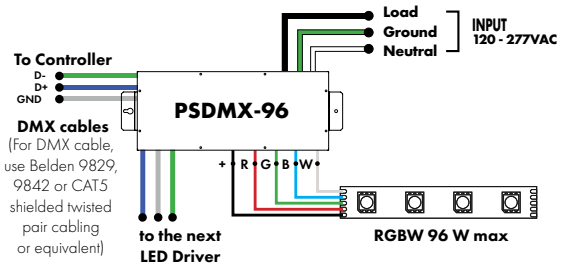

TRIDENT Recessed

RECESSED LINEAR PROFILE

DALI 0% Dimming Power Supplies 120VAC - 277VAC

DALI 0% Dimming Power Supplies 120VAC - 277VAC

MODEL	POWER	OUTPUT
PSDALI - DALI Power Supply dims down to 0%	96 - 96 Watt 3X96 - 3 X 96 Watt	24 - 24 VDC

Features eldoLED's LINEARdrive configurable dimmable drivers

Model	96W	3X96
Length	14.40"	15.75"
Width	5.20"	6.62"
Depth	2.60"	4.95"

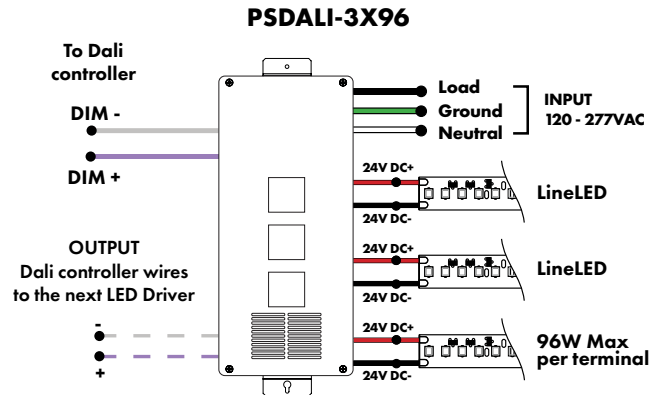
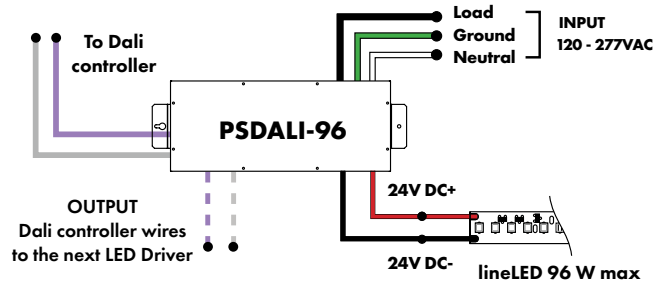

TRIDENT Recessed

RECESSED LINEAR PROFILE



Luminii is a Lutron OEM Advantage Partner
Lutron Power Supplies 1%

MODEL

LTEA4U1UKL - CV240

Lutron - Hi-lume™ 1% 2-wire LED Driver
40W max

(120V forward phase only)

MODEL

L3DA4U1UKL - CV240

Hi-lume™ 1% EcoSystem Voltage LED driver
40W max

MODELS	LTEA41UKL-CV240	L3DA4U1UKL-CV240
Length	4.89"	4.98"
Width	4.00"	4.00"
Depth	2.62"	2.62"

For a complete details on the Lutron Power Supply, see Spec Sheet and Install Guide on the [Resources page](#).



Luminii is a Lutron OEM Advantage Partner
Lutron Power Supplies 0.1%

MODEL

L3D0-96W24V-U

Hi-lume™ 0.1% EcoSystem Voltage LED Driver with Soft-On, Fade-to-Black™
96W max

MODELS	L3D0
Length	10.50"
Width	5.50"
Depth	2.00"

