

Plexineon Rings

Surface Mount

Static White and Monochrome Colors

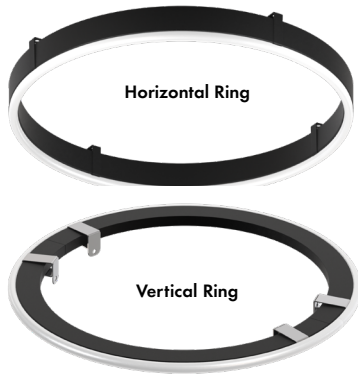

- Easy to install, for interior and exterior accent lighting
- Neon look providing a crisp, clear line of light visible for miles
- Mounting Clips are included in the appropriate quantities
- Operating Temperature: -40° F to 140° F (-40° C to 60° C)
- 24VDC Class 2
- IK10 and 3G rated
- IP67 rated. IP68 rating available upon specific request
- 5 year warranty indoor, 3 year warranty outdoor

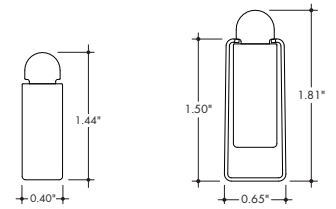

Without Mounting Clip

With Mounting Clip



Technical Information

RING OUTER DIAMETER* (inch)	Plexineon Static White (30K)	Plexineon Monochrome Colors					
		Red	Blue	Green	Magenta	Teal	Yellow
WAVELENGTH	N/A	622 nm	468 nm	525 nm	567 nm	486 nm	563 nm
EFFICACY	39 lm/W	12.1 lm/W	8.1 lm/W	33.8 lm/W	9.2 lm/W	20.9 lm/W	23.2 lm/W
Ø36 (Ø3ft)	Lumen Output	1159 lm	132 lm	104 lm	471 lm	226 lm	584 lm
	Power Consumption	30.2 W	11.3 W	13.2 W	14.1 W	24.5 W	25.4 W
Ø72 (Ø6ft)	Lumen Output	2318 lm	264 lm	207 lm	942 lm	452 lm	1169 lm
	Power Consumption	60.3 W	22.6 W	26.4 W	28.3 W	49.0 W	50.9 W
Ø144 (Ø12ft)	Lumen Output	4637 lm	528 lm	415 lm	1885 lm	905 lm	2337 lm
	Power Consumption	120.6 W	45.2 W	52.8 W	56.5 W	98.0 W	101.8 W
Ø288 (Ø24)	Lumen Output	9274 lm	1056 lm	829 lm	3770 lm	1810 lm	4675 lm
	Power Consumption	241.3 W	90.5 W	105.6 W	113.1 W	196.0 W	218.7 W

*Rings will be made of equal sections no longer than 96" arc length. Rings exceeding 96" will have allowances for additional power feeds.

CCT	Multiplier (reference - 3000K)	TM-30		
		CRI	R _f	R _g
2700K	0.94	90	88	97
3000k	1.00	90	87	97
3500k	1.02	90	87	97
4000k	1.02	90	84	92

Ordering Code

MODEL	RING DIAMETER ¹	RING TYPE	CCT	OUTPUT	LENS	MOUNTING ³	FINISH	POWERFEED POSITION/TYPE
PX-Plexineon	____ Ring diameter in inches, 6"-288" (24ft)	HR-Horizontal Ring VR-Vertical Ring ²	27K-2700K 30K-3000K 35K-3500K 40K-4000K B-Blue G-Green T-Teal Y-Yellow R-Red M-Magenta	SO-Standard	F-Frosted	SM-Surface Mount SML-Surface Mount, L-Tab Clips SMS-Surface Mount, S-Tab Clips SMD-Surface Mount Decorative Clips ⁴	GG-Gloss Grey BK-Matte Black GY-Matte Grey WH-Matte White	B-4-Male Quick Connect One End, Female Quick Connect Other End

1. Rings will be made of equal sections no longer than 96" arc length. Tolerance on size of diameter is +/- 1".
2. Vertical Rings are Convex Bends with the light directed outwards, min diameter 16".
3. 2 mounting clips included for every 12" of diameter, with a minimum of 3 clips.
4. Decorative Clips match the fixture finish, are for indoor use only.

Plexineon Rings

Surface Mount

Static White and Monochrome Colors



Finish Options

BK
Matte Black Finish



WH
Matte White Finish



GY
Matte Grey Finish

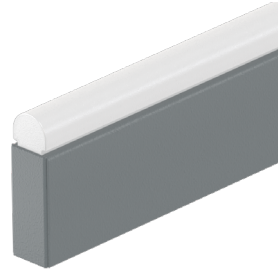

GG
Gloss Grey Finish

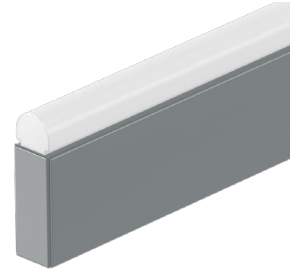

Mounting Clips

- Mounting Clips are included with Plexineon runs in the appropriate quantity, every 30" of linear/arc length for Standard Clips and every 18" of linear/arc length for Decorative Clips.
- Standard Clips have a stainless steel finish, Decorative Clip finishes match the fixture finishes.
- Standard Clip mounting hole is $\varnothing 0.2"$, Decorative Clip mounting hole is $\varnothing 0.16"$.

SM
75-CLP16-001-00
Surface Mount, Standard Clip

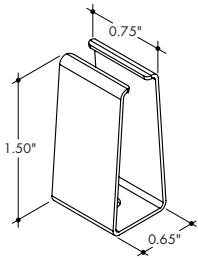

Used for mounting direct to surfaces

SML
75-CLP15-001-00
Surface Mount, L-Tab Clip

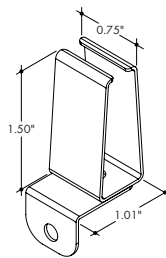

Used for mounting to adjacent surfaces

SMS
75-CLP17-001-00
Surface Mount, S-Tab Clip

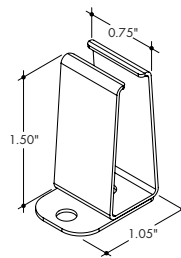

Used for to reduce install time and mounting direct to surfaces with fixture pre-assembled to clips

75-CLP19-001-00
Surface Mount, Standard Joiner Clip

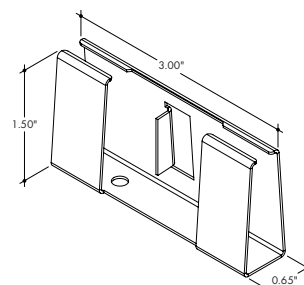

Used to join two fixtures together

SMD
75-CLP36-001-0X
Surface Mount, Decorative Clip

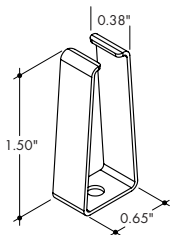

Thinner clip with finish options to match fixtures

75-CLP37-001-0X
Surface Mount, Decorative Joiner Clip

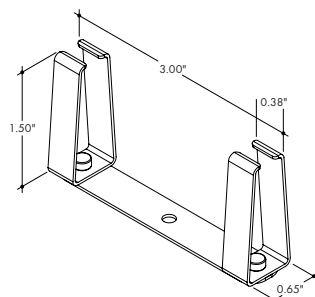

Thinner clip with finish options to match and join two fixtures together for a continuous run

OX	Clip Finish
00	Stainless Steel
01	Matte Black
02	Matte Grey
03	Matte White

70-TOL02-001-01
Mounting Clip Installation Tool

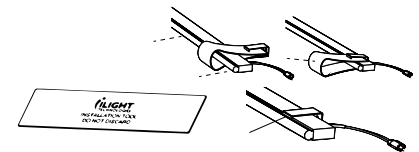

Use for installation of Plexineon into Mounting Clips

Plexineon Rings

Surface Mount

Static White and Monochrome Colors



Ring Types

HR
Horizontal Ring

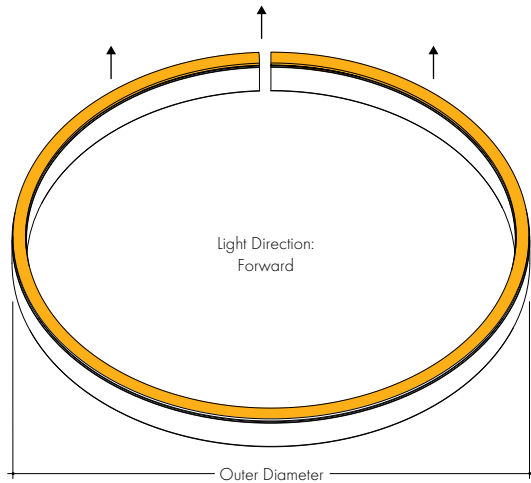

VR
Vertical Ring

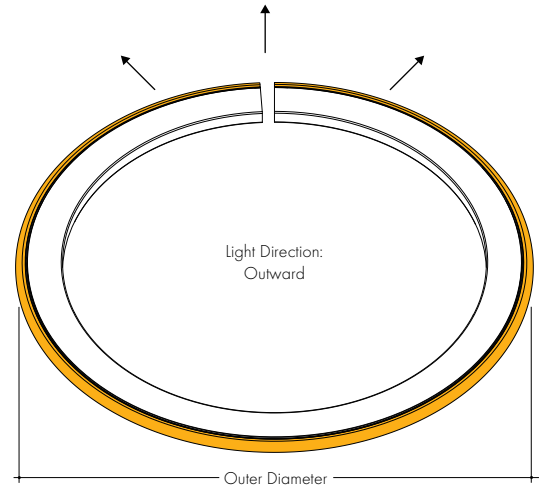

Additional Material

- Ordered separately.

60-H-0001-08
Female Quick Connect
with flying leads

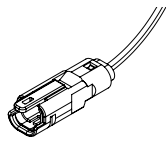

Female Quick Connect with flying leads can be connected to the Power Supply at the start of a run. Can also be used with the Male Quick Connect to make wire jumpers. Use color suffix -08 for Black, -09 for Grey, or -10 for White

60-H-0002-08
Male Quick Connect
with flying leads

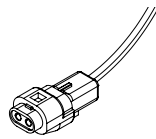

Male Quick Connect with flying leads can be used to make wire jumpers. Use color suffix -08 for Black, -09 for Grey, or -10 for White

60-12-22AWG5BWN
Weatherproof Wire Nut
Silicone Filled

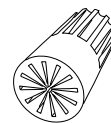

Order 2 per Power Supply

55-STW02-050-00
50 ft of 14 gauge wire Black jacket,
2 conductors

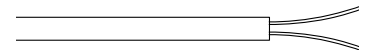

Sunlight, moisture resistant, and flame retardant PVC jacket per UL 1277

Plexineon Rings

Surface Mount

Static White and Monochrome Colors



Sample Layout

PX-48-HR-30K-SO-F-SM-GG-B-4

Plexineon Horizontal Ring, Standard Mounting Clips

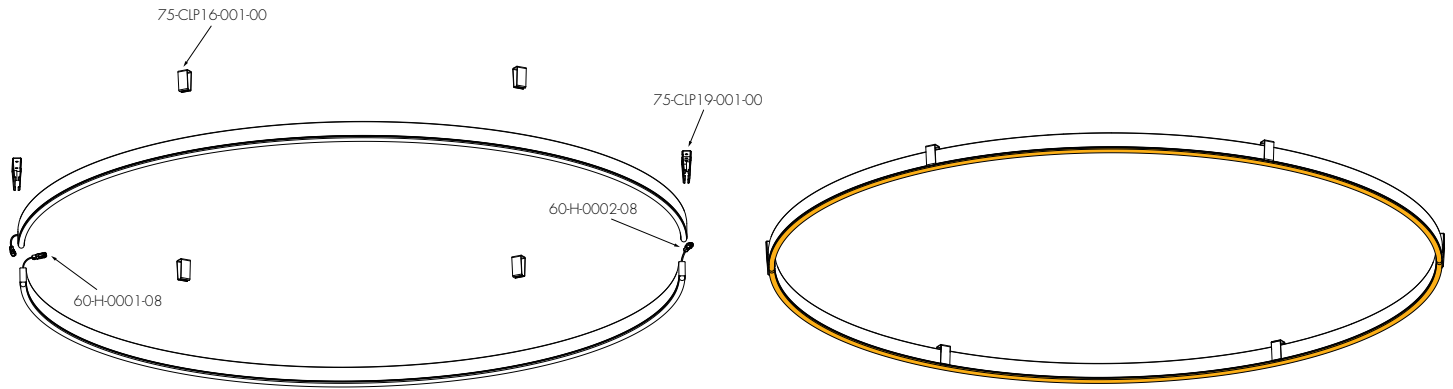

PX-32-VR-30K-SO-F-SM-GG-B-4

Plexineon Vertical Ring, Standard Mounting Clips

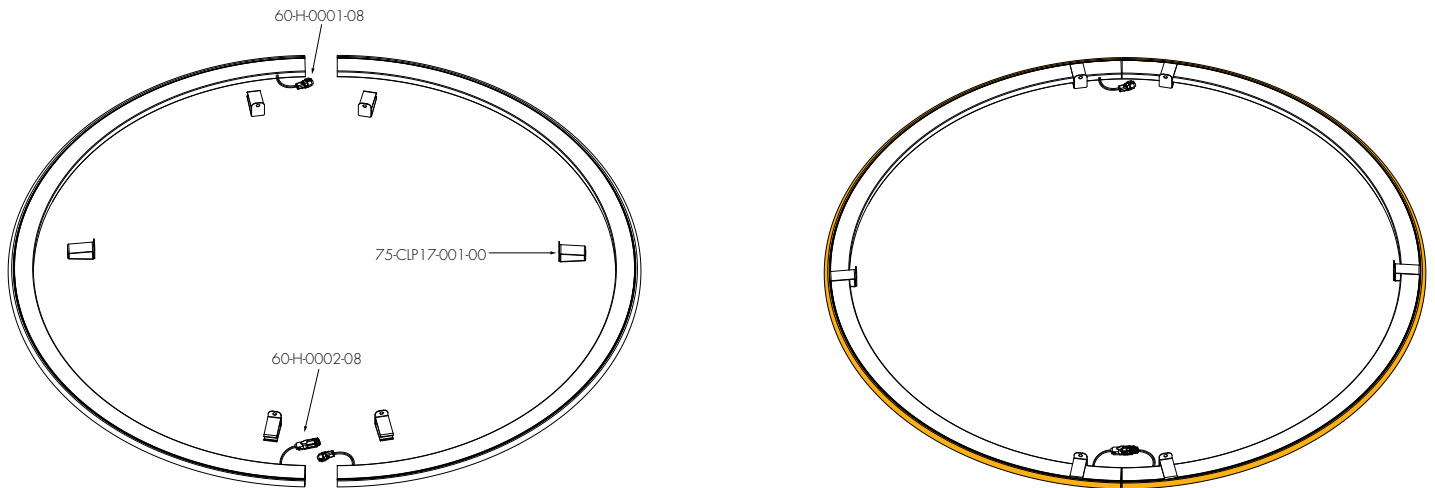

Plexineon Rings

Surface Mount

Static White and Monochrome Colors



Common Applications

Custom Indoor Designs | Coves | Signs | Building Facades | Lobbies | Hallways | Statement Pieces | Restaurants
Corporate Offices | Schools | Residential Towers | Parking Garages | Hotels | Bridges | Benches | Airports



Plexineon Rings

Surface Mount

Static White and Monochrome Colors



Power Supplies

See Power Supply instructions and spec sheet for wiring information. For a complete list of compatible dimmers, see [Compatible Dimming Chart](#) on the Resources page.

Universal Power Supply 1% 120VAC - 277VAC

MODEL	POWER	OUTPUT
PDCU-D - IP20 Dry Series	30 - 30 W 60 - 60 W 96 - 96 W 3X96 - 3X96 W	24 - 24 VDC
PDCU-W - IP66 Wet Series	96 - 96 W 3X96 - 3X96 W	

0-10V dims down to 1%, MLV/ELV/TRIAC dims down to 1%.
For a complete list of compatible dimmers, see [Compatible Dimming Chart](#) on the Resources page.

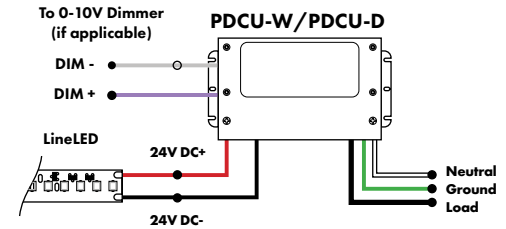

MODELS	PDCU-W 96W	PDCU-W 3X96W	PDCU-D 30W	PDCU-D 60W	PDCU-D 96W	PDCU-D 3X96W
Length	8.66"	11.85"	6.10"	7.93"	8.25"	9.57"
Width	3.73"	4.32"	3.35"	3.35"	4.10"	5.94"
Depth	1.61"	1.81"	1.33"	1.32"	1.56"	1.13"

0-10V Dimming Power Supplies 0.1% 120VAC - 277VAC

MODEL	POWER	OUTPUT	DIMMING
PS010V - 0-10V Power Supply dims down to 0.1%	96 - 96 Watt 3X96 - 3 X 96 Watt	24 - 24 VDC	LIN - Linear LOG - Logarithmic

MODELS	96W	3X96
Length	14.40"	15.75"
Width	5.20"	6.62"
Depth	2.60"	4.95"

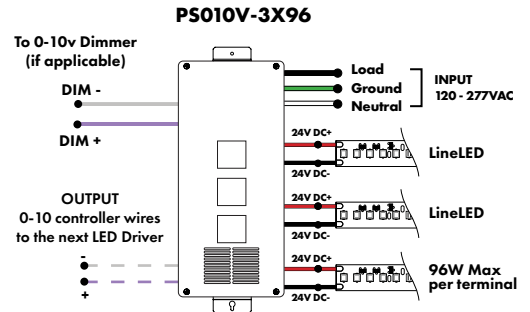
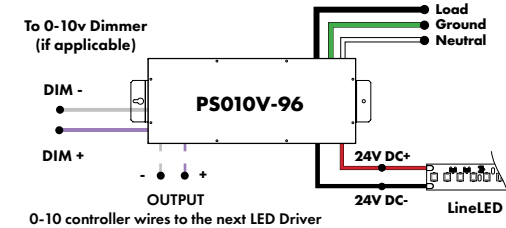

Triac, MLV, & ELV Compatible Dimmers

MODEL	POWER	OUTPUT
PDC - (IP20) Power Supply	96 - 96 Watts	24 - 24 VDC

MODELS	96W
Length	8.25"
Width	4.10"
Depth	1.56"

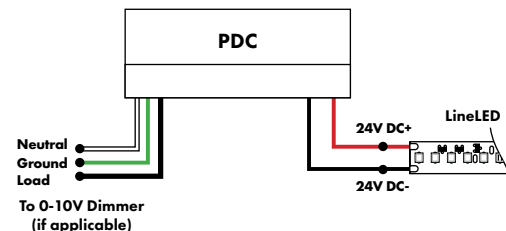

Plexineon Rings

Surface Mount

Static White and Monochrome Colors



Power Supplies

See Power Supply instructions and spec sheet for wiring information. For a complete list of compatible dimmers, see Compatible Dimming Chart on the Resources page.

DMX Dimming Power Supplies 120VAC - 277VAC

MODEL	POWER	OUTPUT
PSDMX	96 - 96 Watt 3X96 - 3 X 96 Watt	24 - 24 VDC

PSDMX - DMX Power Supply dims down to 0%

Features eldoLED's LINEARdrive configurable dimmable drivers

MODELS	96W	3X96
Length	14.40"	15.75"
Width	5.20"	6.62"
Depth	2.60"	4.95"

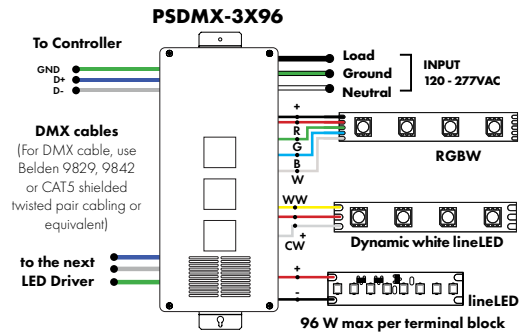
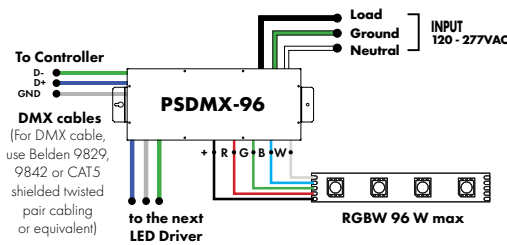

DALI 0% Dimming Power Supplies 120VAC - 277VAC

MODEL	POWER	OUTPUT
PSDALI	96 - 96 Watt 3X96 - 3 X 96 Watt	24 - 24 VDC

PSDALI - DALI Power Supply dims down to 0%

Features eldoLED's LINEARdrive configurable dimmable drivers

Model	96W	3X96
Length	14.40"	15.75"
Width	5.20"	6.62"
Depth	2.60"	4.95"

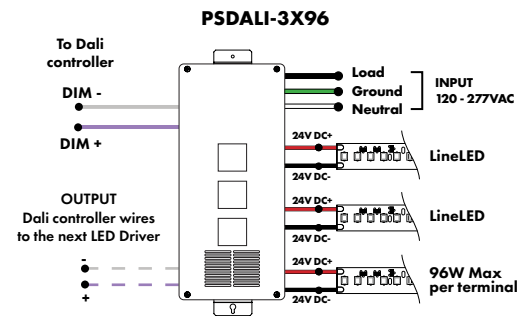
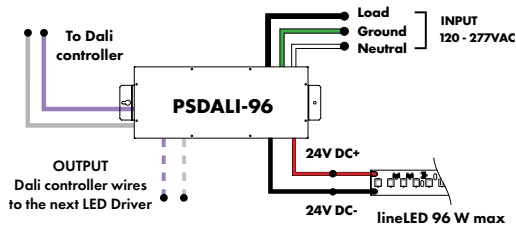

Enlighted Enabled Dimming Power Supplies 120VAC - 277VAC

MODEL	POWER	OUTPUT	DIMMING	LOCATION
PSV - PSV Series	96 - 96 Watt	24 - 24 VDC	ENL - Enlighted Dimming dims down to 0%	D - Damp

PSV - PSV Series 96 - 96 Watt 24 - 24 VDC ENL - Enlighted Dimming dims down to 0% D - Damp

Model	96W
Length	14.40"
Width	5.20"
Depth	2.60"

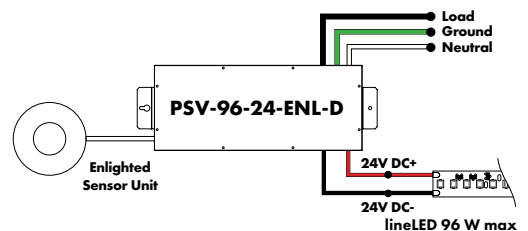

Plexineon Rings Surface Mount

Static White and Monochrome Colors



Power Supplies

See Power Supply instructions and spec sheet for wiring information. For a complete list of compatible dimmers, see Compatible Dimming Chart on the Resources page.

Non-Dimming Power Supply 120VAC - 277VAC

MODEL	POWER	OUTPUT	DIMMING	LOCATION
PSV - PSV Series	96 - 96 Watt	24 - 24 VDC	U2ND - Non Dimming	D - Damp

MODELS	96W
Length	14.40"
Width	5.20"
Depth	2.60"

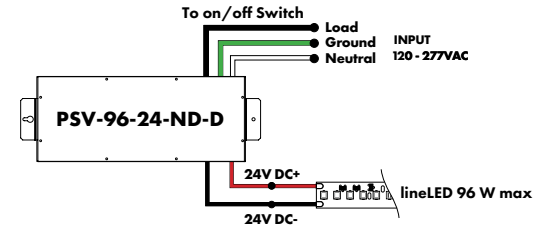

Luminii is a Lutron OEM Advantage Partner

Lutron Power Supplies 1%

MODEL
L3DA4U1UKL-CV240

HiLume™ 1% EcoSystem Voltage LED driver
40W max

MODELS	L3DA4U1UKL-CV240
Length	4.98"
Width	4.00"
Depth	2.62"

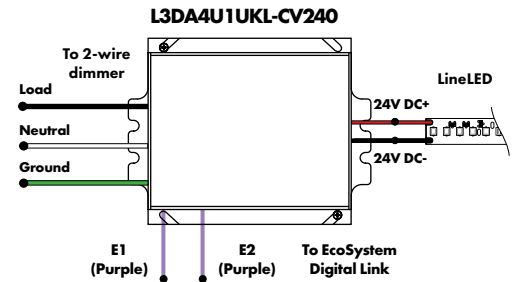

Luminii is a Lutron OEM Advantage Partner

Lutron Power Supplies 0.1%

MODEL
L3D0-96W24V-U

HiLume™ 0.1% EcoSystem Voltage LED Driver with Soft-On, Fade-to-Black™
96W max

MODELS	L3D0
Length	10.50"
Width	5.50"
Depth	2.00"

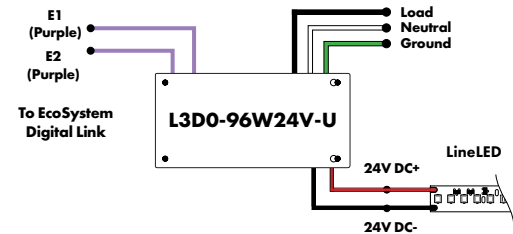

In-Ground Power Supplies

MODEL	POWER	OUTPUT	INPUT
IG - In ground CVE Series CVE - ELV Dimming DALI - eldoLED Dali dimming Both dims down to 0%	96X2 - 2 X 96 Watt	24 - 24 VDC	Blank - 120 V 277 - 240/277 V

MODELS	Dual Circuit
Length	8.40"
Width	8.30"
Depth	8.10"

