

Features

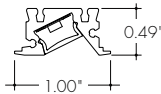

- 24VDC Class 2 and IP68 rated for wet locations, fixtures made to order up to 144". Fixtures can be linked up to 48' depending on output
- Suitable for undercabinet, millwork, direct view, grazer, vanity, architectural reveals, accent lighting and surface mount applications
- Dot free even illumination with frosted lens and high color outputs.
- High Color Quality options offer premium quality and vibrant colors with R9 values up to 97
- High Efficacy options offer best in class output and efficacy with over 390 lm/ft and up to 70 lm/W
- Proprietary strong bond solder method handles up to 50 lbs of pull force on wire leads and connectors
- 3 Year warranty



Finish Options (see page 2 for additional information)

- Base Silver Anodized
- Standard Black Bronze White
- Premium Matte Black Warm Nickel Aged Brass Polished Gold Chrome



Technical Information

TYPE	High Color Quality			High Efficacy			
	72SO	72HO	72VHO	HE48LO	HE48SO	HE48MO	HE48HO
OUTPUT OPTIONS							
Lumens Output (3000K) <small>(with a Clear Lens)</small>	137 lm/ft	222 lm/ft	270 lm/ft	133 lm/ft	184 lm/ft	246 lm/ft	395 lm/ft
Average Power Consumption <small>(for a 4' section)</small>	2.8 W/ft	4.8 W/ft	6 W/ft	1.9 W/ft	2.8 W/ft	3.5 W/ft	6.5 W/ft
Efficacy	49 lm/W	46 lm/W	45 lm/W	70 lm/W	66 lm/W	70 lm/W	61 lm/W
Max Run Length <small>(in series)</small>	40 ft	31 ft	22 ft	48 ft	42 ft	33 ft	21 ft
Max Ambient Temperature*	50°C [122°F]	45°C [113°F]	35°C [95°F]	50°C [122°F]			30°C [86°F]

*Max Ambient Temperature to maintain L70 of 50k+ hours. Exceeding Max Ambient Temperature may result in decreased life/output. Consult Technical Support for specific inquiries.

High Color Quality (72)

CCT	Multiplier <small>(reference - 3000K)</small>	CRI	TM-30		
			R _f	R _g	R ₉
2700K	0.97	97	96	99	93
3000K	1.00	96	95	99	92
3500K	1.01	96	95	100	94
4000K	1.34	97	96	102	92

High Efficacy (HE48)

CCT	Multiplier <small>(reference - 3000K)</small>	CRI	TM-30		
			R _f	R _g	R ₉
2700K	0.94	92	90	99	46
3000K	1.00	92	89	99	62
3500K	1.02	92	89	99	58
4000K	1.02	92	86	94	52

Ordering Code

MODEL	LENGTH ¹	OUTPUT	CCT	LENS ²	MOUNTING	FINISH ³	POSITION TYPE	POWER FEED
MKRAW - Myka Recessed Asymmetric Wet	12"-144" 1" increments	72SO - Standard 72HO - High 72VHO - Very High	27K - 2700K 30K - 3000K 35K - 3500K 40K - 4000K	C - Clear Lens F - Frosted Lens	HS - Hard Surface Mounting Bracket NB - No Bracket	Base SA - Silver Anodized Standard BK - Black BZ - Bronze WH - White Premium MBK - Matte Black WN - Warm Nickel AB - Aged Brass PG - Polished Gold ⁴ CH - Chrome ⁴	LB - Left Back RB - Right Back LE - Left End RE - Left Back	1 - 72" wire leads 1X2 72" wire leads at both ends 2 - 72" wire leads at selected position type and Quick Connect at other 3 - Single Quick Connect 4 - Dual Quick Connect P1 - Plenum 72" wire leads PIX2 - Plenum 72" wire leads at both ends
	12"-144" 2" increments	HE48LO - Low HE48SO - Standard HE48MO - Medium HE48HO - High	27K - 2700K 30K - 3000K 35K - 3500K 40K - 4000K					

1 - Custom lengths and increments are available, please consult Inside Sales with specific request.

2 - All High Efficacy options can be used to comply with Title 24 JAB. High Color Quality options can be used to comply with Title 24 JAB depending on Output, CCT, and lens selections. See multiplier charts to calculate specific efficacies.

3 - Non SA finishes may have extended lead times and price adders.

4 - Polished Gold, and Chrome finishes have a maximum fixture length of 96".

Product Dimensions

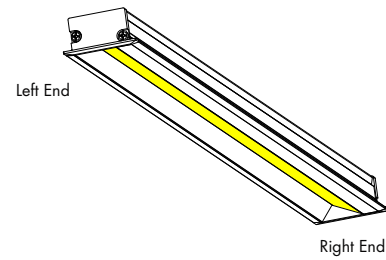
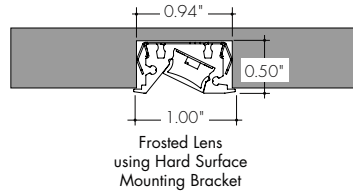
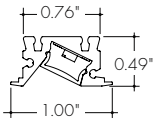

Finish Options

- Finish options are available in a wide variety, allowing for complete customization of style and aesthetic.
- Non Silver Anodized finishes may have extended lead times and price adder.
- Polished Gold and Chrome finishes have a maximum fixture length of 96".
- Custom RALs are available, please consult Inside Sales with specific request.

Silver Anodized Base



Silver Anodized is a soft silver with a clear finish.

Black Standard



Black is a true deep black with a glossy finish.

Bronze Standard



Bronze is a rich, dark brown with a satin finish.

White Standard



White is a polar bright white and field paintable.

Matte Black Premium



Matte Black is a dark, pitch-black with a soft flat finish.

Warm Nickel Premium

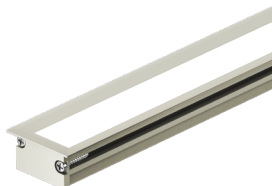

Warm Nickel is a soft, silvery smoke with warm tones and a satin finish.

Aged Brass Premium

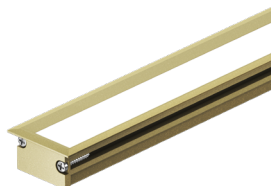

Aged Brass is a deep brown shade with slightly golden undertones.

Polished Gold Premium

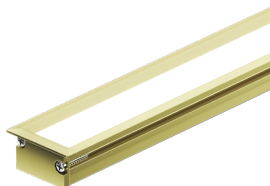

Polished Gold is bright and radiant for a brilliant finish.

Chrome Premium



Chrome is a highly reflective silver polish.

Powerfeeds and Connectors

Linking and Extension Cable Options

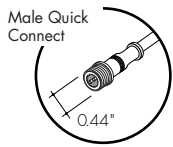

WET-FMA-2-2
Female to Male Adapter, 2 pin

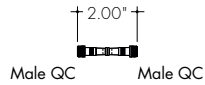

WET-CON-LEAD-M-2-48
Male Wet Connector Cable, 2 pin, 48"

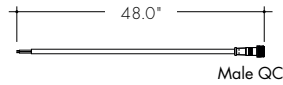

WET-CON-JC-F-M-2-48
Female/Male Wet Jumper Cable, 2 pin, 48"

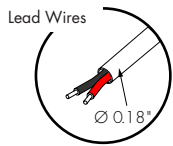
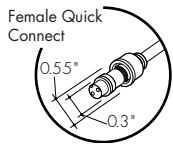
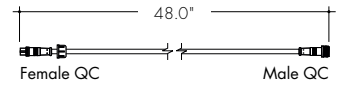

Powerfeeds Position/Type (Right end shown)

Back feeds shown as dashed lines
All wires are 18 AWG unless otherwise specified

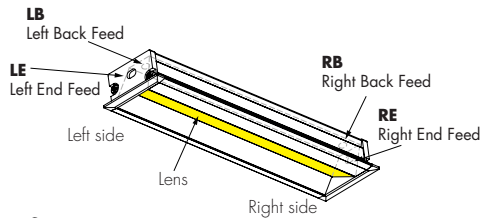

1
72" wire leads

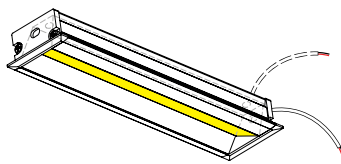

1X2
72" wire leads at both end

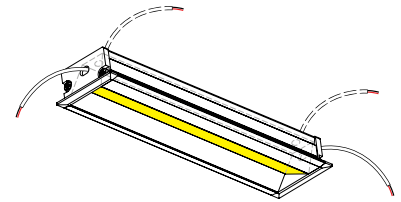

2
72" wire leads at selected end and Female Quick Connect at other

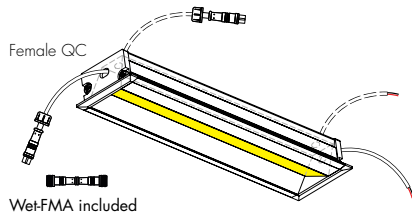

3
Single Female Quick Connect

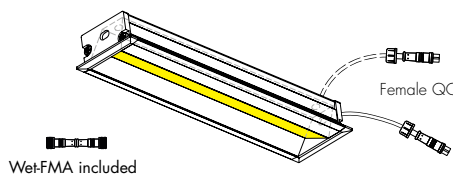

4
Dual Female Quick Connect

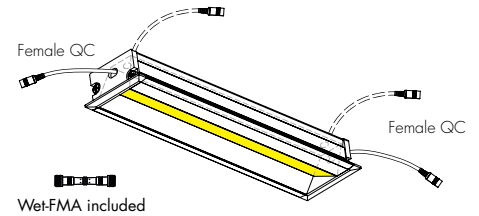

Sample Layout

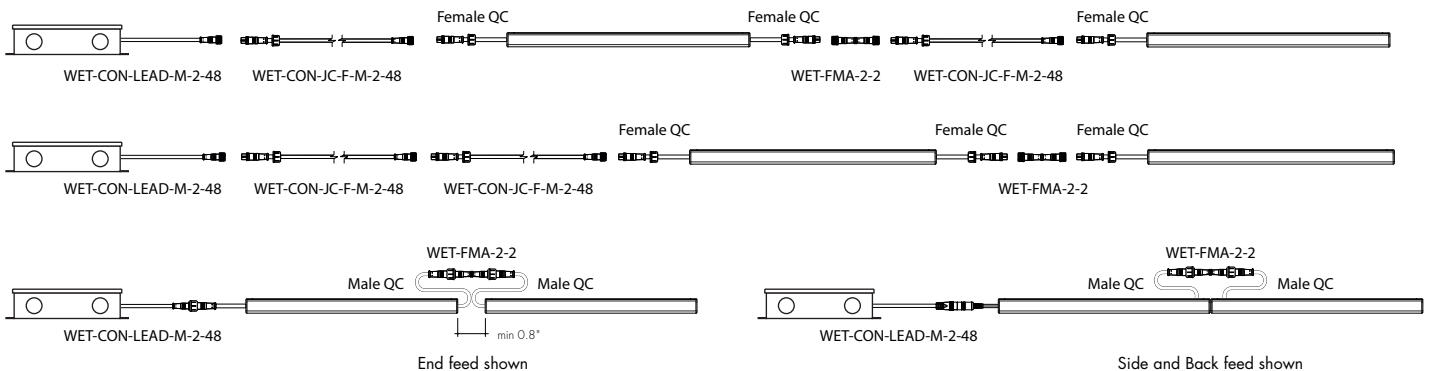

Light Transmission and Dotting

Output Options	Lens/Accessory	
	Clear Lens	Frosted Lens
72SO	CD	ND
72HO	CD	ND
72VHO	CD	ND
HE48LO	CD	SD
HE48SO	CD	SD
HE48MO	CD	SD
HE48HO	CD	SD
Transmission Percentage	100%	59%

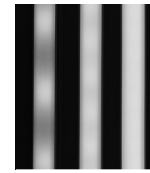

CD SD ND
CD - Clear Dotting
SD - Slight Dotting
ND - No Dotting

Accessory Options

LVSP-WET

Splice box: wet rated, low voltage, gray

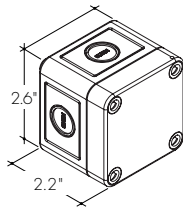

LVSP-WET-CM

Connector for splice box, low voltage for cable management, gray.

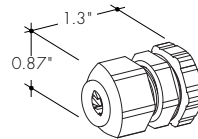

Photometry

MKRAW-48-30K-72VHO-C

Myka Recessed Asymmetric Wet, 4ft, 3000K, 72VHO, Clear Lens

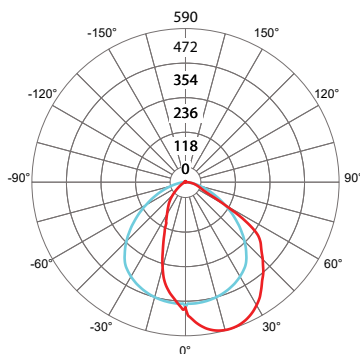

Zonal Lumen Summary 3000K

Zone	Lumen	% Fixture
0-30	345	31.9%
0-40	551	51.1%
0-60	929	86.0%
0-90	1069	99.0%
0-180	1080	100%

Total

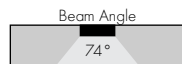

UNIT: CD
 — C0/180
 — C90/270

MKRAW-48-30K-72VHO-F

Myka Recessed Asymmetric Wet, 4ft, 3000K, 72VHO, Frosted Lens

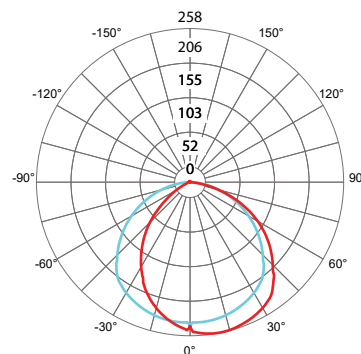

Zonal Lumen Summary 3000K

Zone	Lumen	% Fixture
0-30	181	28.2%
0-40	297	46.4%
0-60	517	80.7%
0-90	634	98.9%
0-180	641	100%

Total

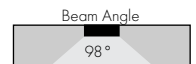

UNIT: CD
 — C0/180
 — C90/270

Power Consumption

Tested at Full Power with PDC Series power supplies.

Standard Nominal Lengths offered provide minimal shadowing. For alternate lengths, please consult Inside Sales with specific request.

High Color Quality (72)

Nominal Length (in)	Actual Length	Watts			Nominal Length (in)	Actual Length	Watts			Nominal Length (in)	Actual Length	Watts			Nominal Length (in)	Actual Length	Watts		
		SO	HO	VHO			SO	HO	VHO			SO	HO	VHO			SO	HO	VHO
12	11 5/16	2.7	4.4	6.2	47	46 1/16	10.2	17.1	22.6	82	81 15/16	18.3	29.5	38.4	117	116 11/16	25.9	40.8	52.4
13	12 8/16	2.7	4.4	6.2	48	47 4/16	10.5	17.4	23.1	83	-	-	-	-	118	117 14/16	26.1	41.1	52.8
14	13 10/16	2.9	4.8	6.7	49	48 6/16	10.7	17.8	23.5	84	83 2/16	18.5	29.8	38.8	119	-	-	-	-
15	14 13/16	3.1	5.2	7.3	50	49 9/16	11.1	18.6	24.4	85	84 5/16	18.7	30.1	39.2	120	119	26.3	41.4	53.2
16	15 15/16	3.4	5.6	7.8	51	50 11/16	11.4	18.9	24.9	86	85 7/16	19.2	30.8	40.0	121	120 3/16	26.5	41.7	53.6
17	-	-	-	-	52	51 14/16	11.6	19.3	25.3	87	86 10/16	19.4	31.1	40.4	122	121 5/16	26.7	42.0	54.0
18	17 2/16	3.6	6.0	8.3	53	-	-	-	-	88	87 12/16	19.6	31.5	40.8	123	122 8/16	27.1	42.6	54.7
19	18 4/16	3.9	6.5	8.9	54	53	11.9	19.7	25.7	89	88 15/16	19.9	31.8	41.1	124	123 10/16	27.3	42.9	55.0
20	19 7/16	4.4	7.3	9.9	55	54 3/16	12.1	20.1	26.1	90	-	-	-	-	125	124 13/16	27.5	43.1	55.4
21	20 10/16	4.6	7.7	10.5	56	55 5/16	12.3	20.5	26.6	91	90 1/16	20.1	32.2	41.5	126	125 15/16	27.7	43.4	55.7
22	21 12/16	4.8	8.1	11.0	57	56 8/16	12.8	21.3	27.4	92	91 4/16	20.4	32.5	41.9	127	-	-	-	-
23	22 15/16	5.1	8.6	11.5	58	57 10/16	13.1	21.6	27.8	93	92 6/16	20.6	32.9	42.3	128	127 2/16	27.9	43.7	56.1
24	-	-	-	-	59	58 13/16	13.3	22.0	28.3	94	93 9/16	21.1	33.6	43.1	129	128 5/16	28.1	43.9	56.4
25	24 1/16	5.3	9.0	12.1	60	59 15/16	13.6	22.4	28.7	95	94 11/16	21.3	33.9	43.4	130	129 7/16	28.5	44.5	57.1
26	25 4/16	5.6	9.4	12.6	61	-	-	-	-	96	95 14/16	21.5	34.2	43.8	131	130 10/16	28.7	44.7	57.4
27	26 6/16	5.8	9.8	13.1	62	61 2/16	13.8	22.8	29.1	97	-	-	-	-	132	131 12/16	28.9	45.0	57.8
28	27 9/16	6.2	10.5	14.1	63	62 4/16	14.0	23.1	29.6	98	97	21.8	34.6	44.2	133	132 15/16	29.1	45.3	58.1
29	28 11/16	6.5	10.9	14.5	64	63 7/16	14.5	23.8	30.5	99	98 3/16	22.0	34.9	44.6	134	-	-	-	-
30	29 14/16	6.7	11.2	15.0	65	64 10/16	14.7	24.1	31.0	100	99 5/16	22.2	35.2	45.0	135	134 1/16	29.3	45.5	58.4
31	-	-	-	-	66	65 12/16	14.9	24.4	31.4	101	100 8/16	22.5	35.9	45.9	136	135 4/16	29.5	45.7	58.7
32	31	6.9	11.6	15.5	67	66 15/16	15.1	24.7	31.9	102	101 10/16	22.7	36.2	46.3	137	136 6/16	29.6	45.9	59.1
33	32 3/16	7.1	12.0	16.0	68	-	-	-	-	103	102 13/16	22.9	36.5	46.7	138	137 9/16	30.0	46.3	59.7
34	33 5/16	7.3	12.3	16.5	69	68 1/16	15.3	25.0	32.4	104	103 15/16	23.1	36.8	47.1	139	138 11/16	30.2	46.5	60.0
35	34 8/16	7.8	13.1	17.4	70	69 4/16	15.5	25.4	32.8	105	-	-	-	-	140	139 14/16	30.3	46.8	60.3
36	35 10/16	8.0	13.4	17.9	71	70 6/16	15.8	25.7	33.3	106	105 2/16	23.3	37.1	47.5	141	-	-	-	-
37	36 13/16	8.2	13.8	18.4	72	71 9/16	16.2	26.3	34.2	107	106 5/16	23.5	37.4	48.0	142	141	30.5	47.0	60.6
38	37 15/16	8.4	14.2	18.9	73	72 11/16	16.4	26.6	34.7	108	107 7/16	23.9	38.1	48.8	143	142 3/16	30.7	47.2	61.0
39	-	-	-	-	74	73 14/16	16.6	26.9	35.1	109	108 10/16	24.1	38.4	49.2	144	143 5/16	30.8	47.4	61.3
40	39 2/16	8.7	14.5	19.3	75	-	-	-	-	110	109 12/16	24.3	38.7	49.6					
41	40 4/16	8.9	14.9	19.8	76	75	16.8	27.3	35.5	111	110 15/16	24.5	39.0	50.0					
42	41 7/16	9.3	15.6	20.7	77	76 3/16	17.1	27.6	35.9	112	-	-	-	-					
43	42 10/16	9.6	16.0	21.2	78	77 5/16	17.3	27.9	36.3	113	112 1/16	24.8	39.3	50.4					
44	43 12/16	9.8	16.4	21.7	79	78 8/16	17.7	28.5	37.2	114	113 4/16	25.0	39.6	50.8					
45	44 15/16	10.0	16.7	22.1	80	79 10/16	17.9	28.9	37.6	115	114 6/16	25.2	39.9	51.2					
46	-	-	-	-	81	80 13/16	18.1	29.2	38.0	116	115 9/16	25.6	40.5	52.0					

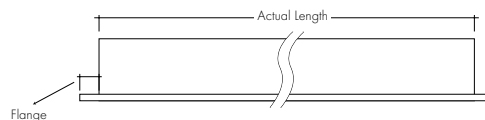

Power Consumption

Tested at Full Power with PDC Series power supplies.

Standard Nominal Lengths offered provide minimal shadowing. For alternate lengths, please consult Inside Sales with specific request.

High Efficacy (HE48)

Nominal Length (in)	Actual Length	Watts				Nominal Length (in)	Actual Length	Watts				Nominal Length (in)	Actual Length	Watts				Nominal Length (in)	Actual Length	Watts			
		LO	SO	MO	HO			LO	SO	MO	HO			LO	SO	MO	HO			LO	SO	MO	HO
12	10 15/16	1.7	2.5	3.5	5.7	47	46 15/16	6.9	10.7	13.3	24.7	82	-	-	-	-	117	116 15/16	17.3	27.3	33.7	57.9	
13	12 15/16	1.7	2.5	3.5	5.7	48	-	-	-	-	-	83	82 15/16	12.5	19.9	23.9	42.2	118	-	-	-	-	
14	-	-	-	-	-	49	48 15/16	7.1	11.2	13.9	25.4	84	-	-	-	-	119	118 15/16	17.5	27.7	34.3	58.7	
15	14 15/16	2.0	3.0	4.0	7.2	50	-	-	-	-	-	85	84 15/16	12.8	20.3	24.5	43.1	120	-	-	-	-	
16	-	-	-	-	-	51	50 15/16	7.4	11.7	14.5	26.3	86	-	-	-	-	121	120 15/16	17.8	28.1	34.9	59.6	
17	16 15/16	2.4	3.5	4.6	8.7	52	-	-	-	-	-	87	86 15/16	13.1	20.8	25.1	44.1	122	-	-	-	-	
18	-	-	-	-	-	53	52 15/16	7.7	12.3	15.1	27.4	88	-	-	-	-	123	122 15/16	18.1	28.6	35.5	60.5	
19	18 15/16	2.7	3.9	5.2	10.2	54	-	-	-	-	-	89	88 15/16	13.4	21.3	25.7	45.0	124	-	-	-	-	
20	-	-	-	-	-	55	54 15/16	8.0	12.9	15.7	28.5	90	-	-	-	-	125	124 15/16	18.3	29.0	36.0	62.1	
21	20 15/16	3.0	4.4	5.8	11.7	56	-	-	-	-	-	91	90 15/16	13.7	21.7	26.3	46.0	126	-	-	-	-	
22	-	-	-	-	-	57	56 15/16	8.4	13.5	16.4	29.5	92	-	-	-	-	127	126 15/16	18.4	29.5	36.6	63.8	
23	22 15/16	3.4	4.9	6.4	13.2	58	-	-	-	-	-	93	92 15/16	14.0	22.1	26.9	47.0	128	-	-	-	-	
24	-	-	-	-	-	59	58 15/16	8.7	14.0	17.0	30.6	94	-	-	-	-	129	128 15/16	18.6	29.9	37.2	65.4	
25	24 15/16	3.7	5.4	7.0	14.7	60	-	-	-	-	-	95	94 15/16	14.3	22.6	27.5	47.9	130	-	-	-	-	
26	-	-	-	-	-	61	60 15/16	9.0	14.6	17.6	31.6	96	-	-	-	-	131	130 15/16	18.8	30.4	37.7	67.0	
27	26 15/16	4.1	5.9	7.5	15.8	62	-	-	-	-	-	97	96 15/16	14.4	22.8	27.8	48.4	132	-	-	-	-	
28	-	-	-	-	-	63	62 15/16	9.4	15.2	18.2	32.6	98	-	-	-	-	133	132 15/16	18.9	30.8	38.3	68.6	
29	28 15/16	4.4	6.4	8.1	16.8	64	-	-	-	-	-	99	98 15/16	14.7	23.3	28.5	49.4	134	-	-	-	-	
30	-	-	-	-	-	65	64 15/16	9.7	15.6	18.7	33.7	100	-	-	-	-	135	134 15/16	19.1	31.2	38.9	70.2	
31	30 15/16	4.8	6.9	8.7	17.9	66	-	-	-	-	-	101	100 15/16	15.0	23.7	29.0	50.4	136	-	-	-	-	
32	-	-	-	-	-	67	66 15/16	10.0	16.1	19.2	34.7	102	-	-	-	-	137	136 15/16	19.3	31.8	39.4	70.7	
33	32 15/16	5.0	7.2	9.0	18.5	68	-	-	-	-	-	103	102 15/16	15.3	24.1	29.6	51.3	138	-	-	-	-	
34	-	-	-	-	-	69	68 15/16	10.4	16.5	19.8	35.7	104	-	-	-	-	139	138 15/16	19.5	32.3	40.0	71.2	
35	34 15/16	5.4	7.7	9.6	19.5	70	-	-	-	-	-	105	104 15/16	15.6	24.6	30.2	52.3	140	-	-	-	-	
36	-	-	-	-	-	71	70 15/16	10.7	17.0	20.3	36.7	106	-	-	-	-	141	140 15/16	19.8	32.8	40.6	71.8	
37	36 15/16	5.7	8.2	10.2	20.6	72	-	-	-	-	-	107	106 15/16	15.8	25.0	30.7	53.2	142	-	-	-	-	
38	-	-	-	-	-	73	72 15/16	11.0	17.4	20.8	37.7	108	-	-	-	-	143	142 15/16	20.0	33.3	41.1	72.3	
39	38 15/16	6.0	8.7	10.8	21.5	74	-	-	-	-	-	109	108 15/16	16.1	25.5	31.3	54.2	144	-	-	-	-	
40	-	-	-	-	-	75	74 15/16	11.3	17.9	21.4	38.7	110	-	-	-	-	-	-	-	-	-	-	
41	40 15/16	6.2	9.2	11.4	22.3	76	-	-	-	-	-	111	110 15/16	16.4	25.9	31.9	55.2	-	-	-	-	-	
42	-	-	-	-	-	77	76 15/16	11.6	18.4	22.0	39.6	112	-	-	-	-	-	-	-	-	-	-	
43	42 15/16	6.4	9.7	12.0	23.1	78	-	-	-	-	-	113	112 15/16	16.7	26.4	32.5	56.1	-	-	-	-	-	
44	-	-	-	-	-	79	78 15/16	11.9	18.9	22.7	40.5	114	-	-	-	-	-	-	-	-	-	-	
45	44 15/16	6.7	10.2	12.6	23.9	80	-	-	-	-	-	115	114 15/16	17.0	26.8	33.1	57.0	-	-	-	-	-	
46	-	-	-	-	-	81	80 15/16	12.2	19.4	23.3	41.4	116	-	-	-	-	-	-	-	-	-	-	

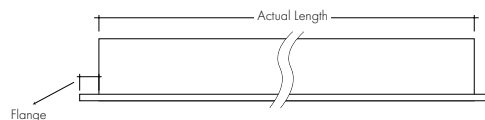

Voltage Drop Calculator

The below chart assumes nominal voltage of 24 Volts and a Voltage Drop Allowance of 3% through the wire

Wattage [W]	Maximum Wire Length From Power Supply to Start of Run [ft]						
	12 AWG	14 AWG	16 AWG	18 AWG	20 AWG	22 AWG	24 AWG
5	1088.2	684.4	430.3	270.6	170.2	107.1	67.3
10	544.1	342.2	215.1	135.3	85.1	53.5	33.7
15	362.7	228.1	143.4	90.2	56.7	35.7	22.4
20	272.0	171.1	107.6	67.7	42.6	26.8	16.8
25	217.6	136.9	86.1	54.1	34.0	21.4	13.5
30	181.4	114.1	71.7	45.1	28.4	17.8	11.2
35	155.5	97.8	61.5	38.7	24.3	15.3	9.6
40	136.0	85.5	53.8	33.8	21.3	13.4	8.4
45	120.9	76.0	47.8	30.1	18.9	11.9	7.5
50	108.8	68.4	43.0	27.1	17.0	10.7	6.7
55	98.9	62.2	39.1	24.6	15.5	9.7	6.1
60	90.7	57.0	35.9	22.6	14.2	8.9	5.6
65	83.7	52.6	33.1	20.8	13.1	8.2	5.2
70	77.7	48.9	30.7	19.3	12.2	7.6	4.8
75	72.5	45.6	28.7	18.0	11.3	7.1	4.5
80	68.0	42.8	26.9	16.9	10.6	6.7	4.2
85	64.0	40.3	25.3	15.9	10.0	6.3	4.0
90	60.5	38.0	23.9	15.0	9.5	5.9	3.7
96	56.7	35.6	22.4	14.1	8.9	5.6	3.5

Power Supplies

See Power Supply instructions and spec sheet for wiring information. For a complete list of compatible dimmers, see Compatible Dimming Chart on the Resources page.

Universal Power Supply 1% 120VAC - 277VAC

MODEL	POWER	OUTPUT
PDCU-D - IP20 Dry Series	30 - 30 W 60 - 60 W 96 - 96 W 3X96 - 3X96 W	24 - 24 VDC
PDCU-W - IP66 Wet Series	96 - 96 W 3X96 - 3X96 W	

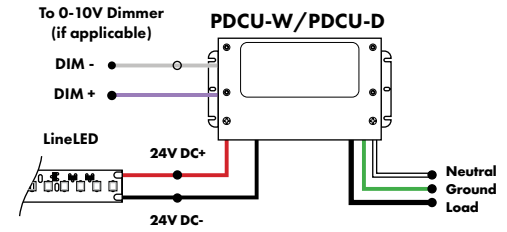

MODELS	PDCU-W 96W	PDCU-W 3X96W	PDCU-D 30W	PDCU-D 60W	PDCU-D 96W	PDCU-D 3X96W
Length	8.66"	11.85"	6.10"	7.93"	8.25"	9.57"
Width	3.73"	4.32"	3.35"	3.35"	4.10"	5.94"
Depth	1.61"	1.81"	1.33"	1.32"	1.56"	1.13"

0-10V dims down to 1%, MLV/ELV/TRIAC dims down to 1%. For a complete list of compatible dimmers, see [Compatible Dimming Chart](#) on the Resources page.

0-10V Dimming Power Supplies 0.1% 120VAC - 277VAC

MODEL	POWER	OUTPUT	DIMMING
PS010V - 0-10V Power Supply dims down to 0.1%	96 - 96 Watt 3X96 - 3 X 96 Watt	24 - 24 VDC	LIN - Linear LOG - Logarithmic

MODELS	96W	3X96
Length	14.40"	15.75"
Width	5.20"	6.62"
Depth	2.60"	4.95"

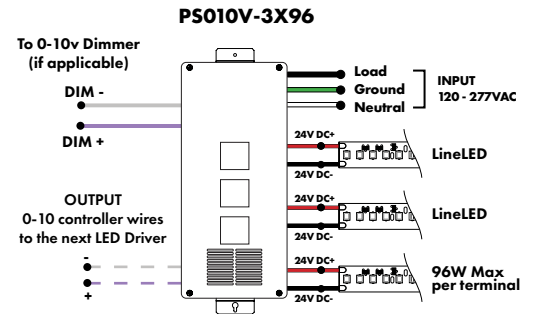
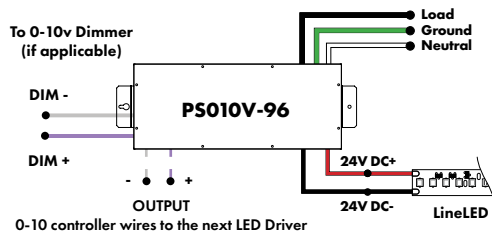

Triac, MLV, & ELV Compatible Dimmers

MODEL	POWER	OUTPUT
PDC - (IP20) Power Supply	96 - 96 Watts	24 - 24 VDC

MODELS	96W
Length	8.25"
Width	4.10"
Depth	1.56"

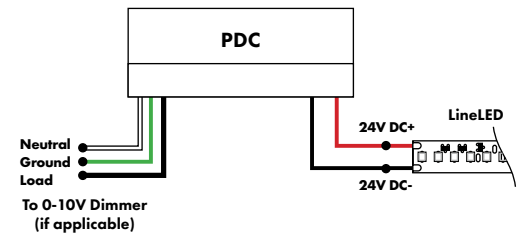

Athena 0-10V LED Driver

MODEL	INPUT CONTROL	ENVIRONMENT	WATTAGE	OUTPUT	FEATURE
PS-Power Supply, 120-277VAC	010V-LIN-0-10V Dimming, Linear 010V-LOG 0-10V Dimming, Logarithmic	D-Dry	96-96 W	24-24 VDC	AWN-R-Athena

MODELS	96W
Length	14.40"
Width	5.20"
Depth	2.60"

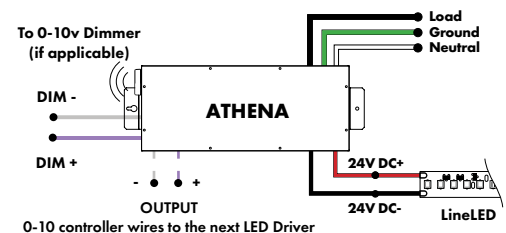

Power Supplies

See Power Supply instructions and spec sheet for wiring information. For a complete list of compatible dimmers, see Compatible Dimming Chart on the Resources page.

DMX Dimming Power Supplies 120VAC - 277VAC

MODEL	POWER	OUTPUT
PSDMX - DMX Power Supply dims down to 0%	96 - 96 Watt 3X96 - 3 X 96 Watt	24 - 24 VDC

Features eldoLED's LINEARdrive configurable dimmable drivers

MODELS	96W	3X96
Length	14.40"	15.75"
Width	5.20"	6.62"
Depth	2.60"	4.95"

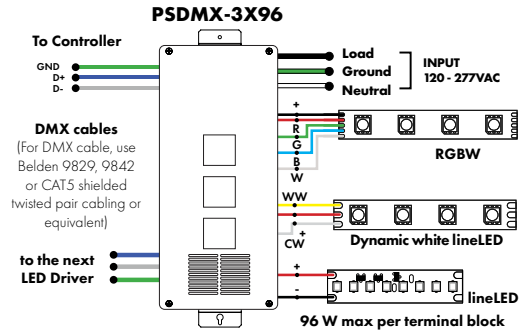
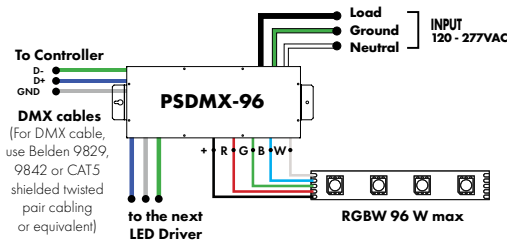

DALI 0% Dimming Power Supplies 120VAC - 277VAC

MODEL	POWER	OUTPUT
PSDALI - DALI Power Supply dims down to 0%	96 - 96 Watt 3X96 - 3 X 96 Watt	24 - 24 VDC

Features eldoLED's LINEARdrive configurable dimmable drivers

Model	96W	3X96
Length	14.40"	15.75"
Width	5.20"	6.62"
Depth	2.60"	4.95"

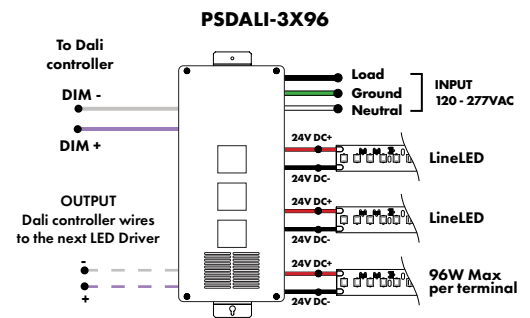
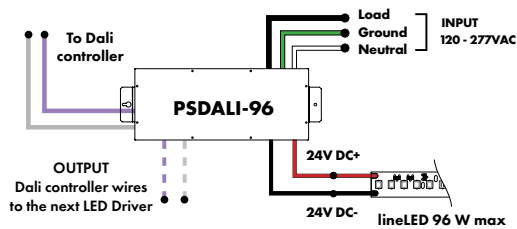

Enlighted Enabled Dimming Power Supplies 120VAC - 277VAC

MODEL	POWER	OUTPUT	DIMMING	LOCATION
PSV - PSV Series	96 - 96 Watt	24 - 24 VDC	ENL - Enlighted Dimming dims down to 0%	D - Damp

Model	96W
Length	14.40"
Width	5.20"
Depth	2.60"

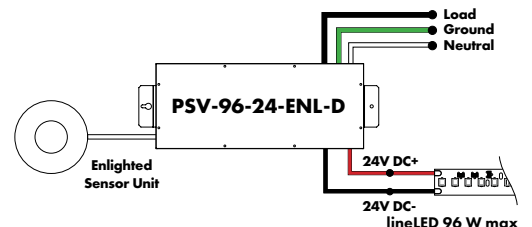

Power Supplies

See Power Supply instructions and spec sheet for wiring information. For a complete list of compatible dimmers, see Compatible Dimming Chart on the Resources page.

Non-Dimming Power Supply 120VAC - 277VAC

MODEL	POWER	OUTPUT	DIMMING	LOCATION
PSV - PSV Series	96 - 96 Watt	24 - 24 VDC	ND - Non Dimming	D - Damp

MODELS	96W
Length	14.40"
Width	5.20"
Depth	2.60"

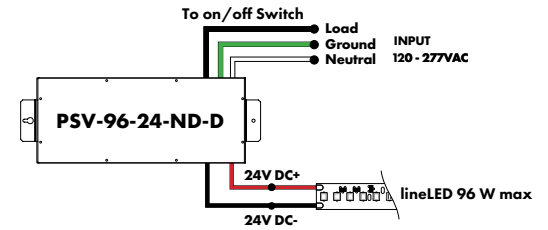

Luminii is a Lutron OEM Advantage Partner

Lutron Power Supplies 1%

MODEL
L3DA4U1UKL-CV240

HiLume™ 1% EcoSystem Voltage LED driver
40W max

MODELS	L3DA4U1UKL-CV240
Length	4.98"
Width	4.00"
Depth	2.62"

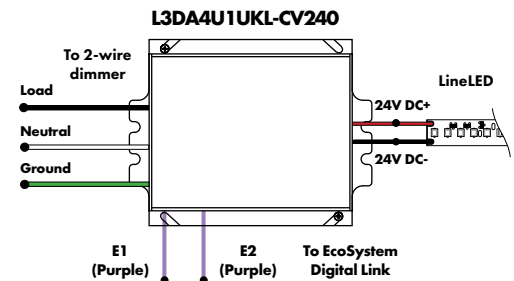

Luminii is a Lutron OEM Advantage Partner

Lutron Power Supplies 0.1%

MODEL
L3D0-96W24V-U

HiLume™ 0.1% EcoSystem Voltage LED Driver with Soft-On, Fade-to-Black™
96W max

MODELS	L3D0
Length	10.50"
Width	5.50"
Depth	2.00"

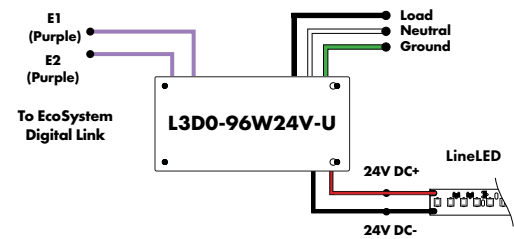

In-Ground Power Supplies

MODEL	POWER	OUTPUT	INPUT
IG - In ground CVE Series	CVE - ELV Dimming	96X2 - 2 X 96 Watt	Blank - 120 V 277 - 240/277 V

Dims down to 0%

MODELS	Dual Circuit
Length	8.40"
Width	8.30"
Depth	8.10"

