

LETO 11

SURFACE CONDUIT ASYMMETRIC LED CYLINDER
TUNABLE WHITE & WARM DIM



Features

- Nine drivers selections available to cover wide range of applications.
- Three output options available up to 1300 lumens.
- 5 year warranty.

Finish Options

- White
- Black
- Silver
- Mocha
- Charcoal
- Cerulean
- Firebrick



Technical Information

TYPE	WD1830			TW2765
	OUTPUT OPTIONS	700 lm	1000lm	1300lm
Fixture wattage	8.51 W	11.16 W	16.06 W	16.41 W
Delivered Lumen at full on	807 lm	1129 lm	1597 lm	1141 lm
Efficacy	95 lm/W	101 lm/W	99 lm/W	70 lm/W
Center Beam Candlepower (18° Faceted Reflector)	5325 cd	7692 cd	11834 cd	7571 cd

CCT	CRI	TM-30		
		R _f	R _g	R ₉
1800K	94	90	93	61
3000K	94	89	97	72
2700K	91	90	96	59
6500K	93	87	97	73

Integral Driver Example: Fixture LET11-SC-07-WD1830-ASM-DL-WH-WH-PHSD-NA

Remote Driver Example: Fixture LET11-SC-07-WD1830-ASM-DL-WH-WH-PHSD-NA
HRM-LET11-SC-07-WD1830-PHSD-NA

Ordering Code

Fixture

MODEL	TYPE	OUTPUT	CCT	OPTIC	ACCESSORY	BODY FINISH	BAFFLE FINISH
LET11 - Leto 11	SC - Surface Conduit	07 - 700 lumens 10 - 1000 lumens 13 - 1300 lumens	WD1830 - Warm Dim, 1800K-3000K TW2765 - Tunable White, 2700K-6500K ⁵	ASM - Asymmetric	DL - Diffusing Lens	Standard WH - White BK - Black SL - Silver Premium ¹ MA - Mocha CC - Charcoal CR - Cerulean FB - Firebrick	Standard WH - White BK - Black SL - Silver Premium ¹ MA - Mocha CC - Charcoal CR - Cerulean FB - Firebrick

DRIVER²

DRIVER OPTIONS⁴

PHSD - Forward/Reverse Phase, 1% Dimming, 120V Only
010S - 0-10V, 1% Dimming, 120/277V
0103 - 0-10V, 1% Dimming, 347V Only
010L - EdoLED, 0-10V, Linear, 0.1% Dimming, 120/277V
010G - EdoLED, 0-10V, Log, 0.1% Dimming, 120/277V
DALI - EdoLED, DALI Protocol 2, DT-6, 0.1% Dimming, 120/277V
DALI8 - EdoLED, DALI Protocol 2, DT-8, 0.1% Dimming, 120/277V
LUTE - Lutron HiLume Ecodigital, 1% Dimming, 120V/277V
DMX - EdoLED, DMX, 0.1% Dimming, 120V/277V

NA - None
EMG - Emergency Driver³

1 - Premium finishes may have extended lead times. Custom RALs are available, please consult Inside Sales with specific request.

2 - All drivers remote except PHSD/010S driver options.

3 - Emergency option comes prewired from factory with driver in remote housing. 8W of continuous power provided for a minimum of 90 minutes. Must be installed within 30 feet of luminaire using 18 AWG wire. Not available with 0103, DMX, DALI8 or LUTE Driver.

4 - AWNR/CSMB available upon request, contact Sense for details.

5 - TW2765 only available with 13 lumens and 010L/010G/DALI8/DMX. Always remote mounted. Cannot use with EMG.

CONTACT FACTORY FOR MORE OPTIONS.

LETO 11

SURFACE CONDUIT ASYMMETRIC LED CYLINDER
TUNABLE WHITE & WARM DIM

Dimensions

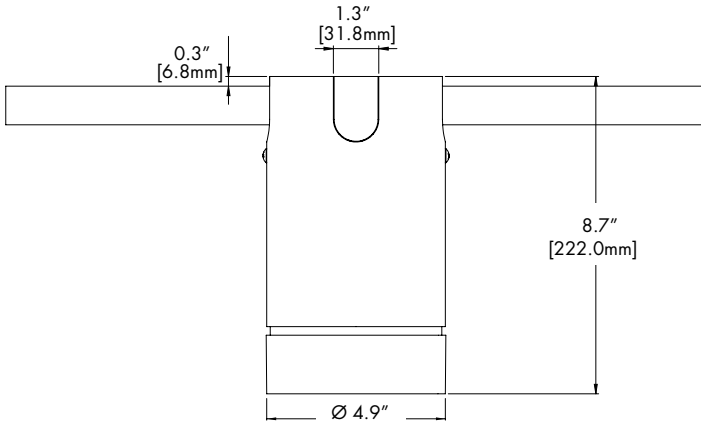

Lens

DL
Diffusing Lens



Light Loss Factor: 87%*

*Light Loss Factor calculated with 60° faceted reflector.

LETO 11

SURFACE CONDUIT ASYMMETRIC LED CYLINDER
TUNABLE WHITE & WARM DIM



Remote Driver Housing

Depending on the options selected in the order code on page 1, a Remote Driver Housing may be required. This will automatically be generated and put on your order as necessary.

REMOTE DRIVER	MODEL	CCT	OUTPUT	DRIVER	DRIVER OPTIONS
HRM-Housing, Remote	LET11-SC-Leto 11 Surface Conduit	Same as Fixture	Same as Fixture	Same as Fixture	Same as Fixture

Maximum mounting distance to luminaire using 18 AWG wire						
010S	PHSD	010L	010G	DALI DALI8	DMX	LUTE
16'	16'	72'	72'	72'	149'	15'

HRM Single with Externally Mounted Driver

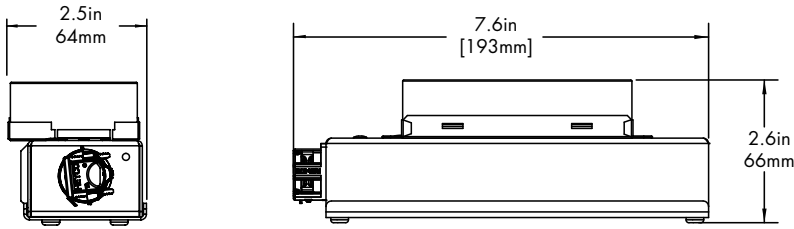

Driver
010L or 010G
010S
010L or 010G or 010S
DALI or LUTE

HRM Single

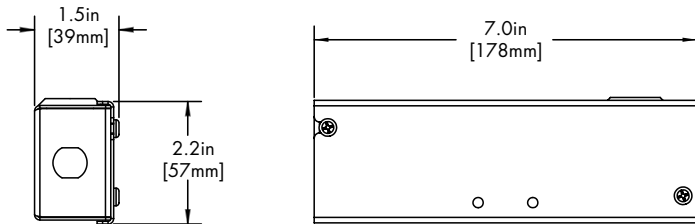

Driver
PHSD

HRM Double

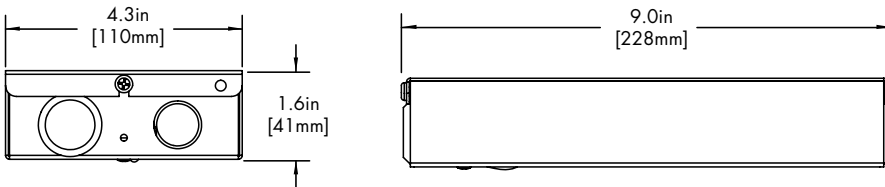

Driver
DALI8
DMX

EMG Emergency Driver

120 minute EMG operation time.

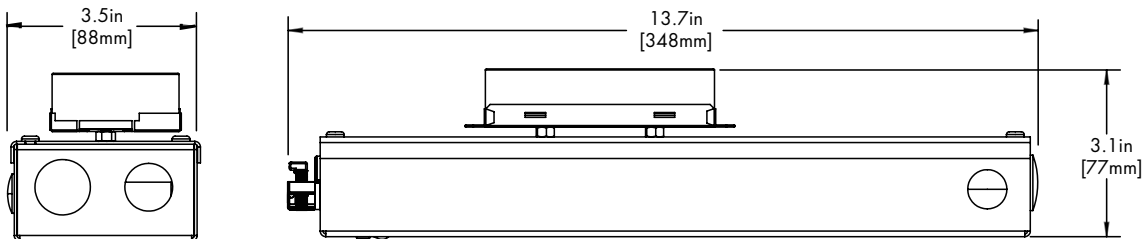

Driver
EMG

LETO 11

SURFACE CONDUIT ASYMMETRIC LED CYLINDER
TUNABLE WHITE & WARM DIM

Standard Colors

BK
Black



WH
White



SL
Silver



Premium Colors

MA
Mocha

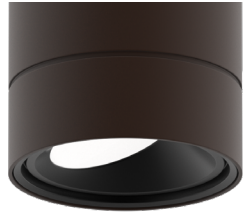

CC
Charcoal



CR
Cerulean

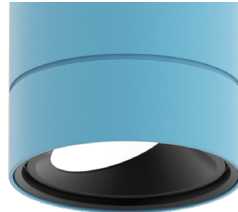

FB
Firebrick

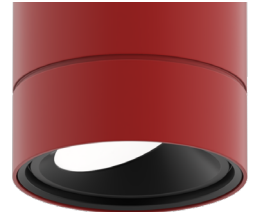

Two Tone Baffle

Inside finish refers to Baffle Finish selection from page 1. Any combination may be used for baffle and body finishes.

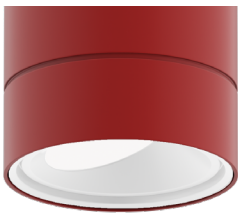

LETO 11

SURFACE CONDUIT ASYMMETRIC LED CYLINDER
TUNABLE WHITE & WARM DIM

TM-30

Warm Dim 1800K

COLOR VECTOR GRAPHIC

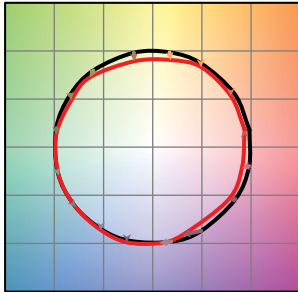

— Reference Source — Test Source

Warm Dim 3000K

COLOR VECTOR GRAPHIC

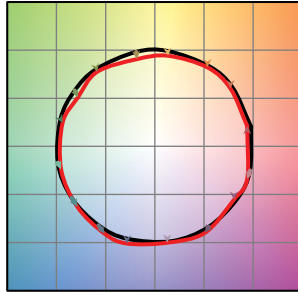

— Reference Source — Test Source

Tunable White 2700K

COLOR VECTOR GRAPHIC

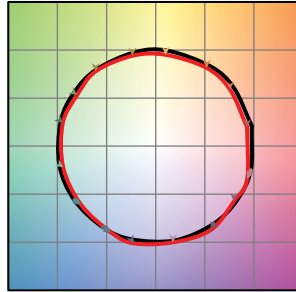

— Reference Source — Test Source

Tunable White 6500K

COLOR VECTOR GRAPHIC

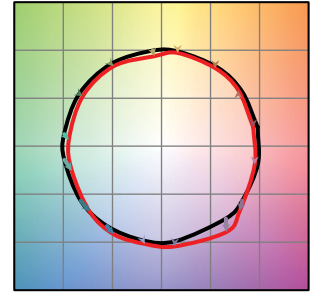

— Reference Source — Test Source

Photometry

18° Faceted Reflector

