

**Features**

LLRGB42 is a small profile, bright, color-changing LED strip. Increased pitch provides more continuous light, while a High Output option offers incredible brightness. Luminii attention to color quality provides balanced output across the color gamut, allowing production of millions of beautiful colors.



**Mounting**

LED strip is equipped with 3M™ adhesive transfer tape (9472LE).

**Applications**

Indoor only - millwork, cove, architectural reveals, undercabinet, display case, handrail, accent lighting.

**Approvals**

Class 2 damp listed

**Operating voltage**

24 VDC

**Life (L70)**

50,000 hours

**Warranty**

5 years



**Technical information**

TYPE	LLRGB42	
	SO	HO
<b>OUTPUT OPTIONS</b>		
Lumens Output (all channels full on)	210 lm/ft	309 lm/ft
Average Power Consumption (for a 4" section)	4.5 W/ft	8.3 W/ft
Cutting Increment (in)	1.97"	
Pitch Length	0.28"	
Efficacy	47 lm/W	37 lm/W
Max Run Length (in series)	28 ft	13 ft
Dimensions	0.39" W x 0.07" H	

Dominant Wavelength	
Color	RGB/RGBW
Red	620nm
Green	525nm
Blue	467nm

**Section Start/End Options**

**SL**

Soldered lead wires (72")

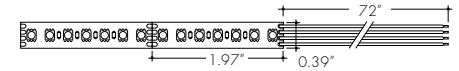

**NC**

No connector

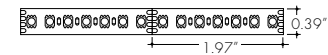

**LF**

Lead Female 3" cable

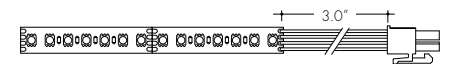

**LM**

Lead Male 3" cable



**Ordering Code**

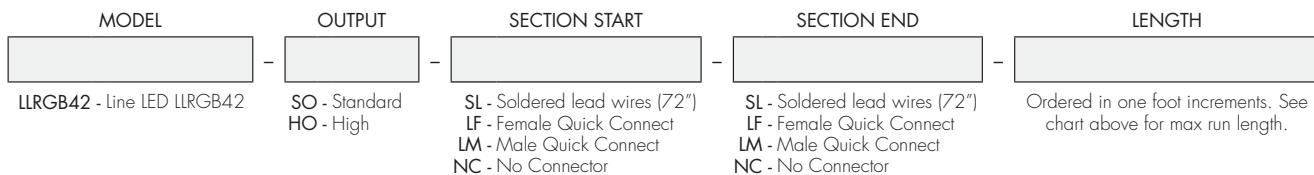

**Accessories**

**CL1**  
Mounting clip

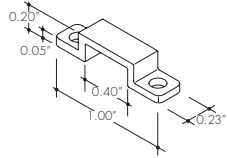

**LVSP-4T-BK**  
Low Voltage, 4 Terminal Splice Box, Black

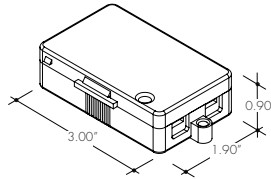

**LL.ZIP**  
Cable/Wire Strain Relief Clip

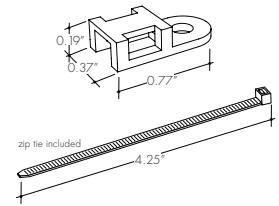

Recommended every 12" when LineLED strip is facing down

**Lens Options / Light Transmission**

<b>C</b> Clear	<b>HF</b> Half (50%) Frosted	<b>GR</b> Graze	<b>F</b> Frosted	<b>FF</b> Flat Frosted	<b>R</b> Raised	<b>S</b> Square Frosted	<b>Q</b> Round Square Frosted	<b>13°</b> 13° Semi-Frosted
<b>BOS Channel (BOSC-XX)</b> 	<b>CLA Channel (CLAC-XX)</b> 	<b>MCAL Channel (MCALC-XX)</b> 	<b>K45V Channel (K45V-XX)</b> 					
<b>F</b> 52% <b>SI</b> 66% <b>R</b> 60% <b>G</b> 76%	<b>S</b> 62% <b>Q</b> 65%	<b>C</b> 94%	<b>C</b> 82% <b>HF</b> 68% <b>F</b> 45% <b>13°</b> 75%					
<b>K45R Channel (K45R-XX)</b> 	<b>KiloR Channel (KILORC-XX)</b> 	<b>Kilo Channel (KILOC-XX)</b> 	<b>KL Channel (KLC-XX)</b> 					
<b>RF</b> 61%	<b>C</b> 85% <b>F</b> 75%	<b>C</b> 85% <b>F</b> 75%	<b>C</b> 81% <b>HF</b> 67% <b>F</b> 51%					
<b>KRL Channel (KRLC-XX)</b> 	<b>KM Channel (KMC-XX)</b> 	<b>KRM Channel (KRMC-XX)</b> 	<b>KS Channel (KSC-XX)</b> 					
<b>C</b> 81% <b>HF</b> 67% <b>F</b> 51%	<b>C</b> 82% <b>HF</b> 68% <b>F</b> 45% <b>FF</b> 52% <b>R</b> 58% <b>GR</b> 57%	<b>C</b> 82% <b>HF</b> 68% <b>F</b> 45% <b>FF</b> 52% <b>GR</b> 57%	<b>C</b> 86% <b>HF</b> 71% <b>F</b> 56% <b>FF</b> 60% <b>R</b> 85% <b>M</b> 64%					
<b>KRS Channel (KRSC-XX)</b> 	<b>KXL Channel (KXLC-XX)</b> 	<b>KRXL Channel (KRXLC-XX)</b> 	<b>RO15 Channel (RO15-XX)</b> 					
<b>C</b> 86% <b>HF</b> 71% <b>F</b> 56% <b>FF</b> 60% <b>M</b> 64%	<b>C</b> 81% <b>HF</b> 67% <b>F</b> 51%	<b>C</b> 81% <b>HF</b> 67% <b>F</b> 51%	<b>C</b> 65% <b>F</b> 41%					

**Led Dotting per Extrusion**

using the frosted lens option

Extrusion	LLRGB42
KSC, KRSC	CD
KMC, KRMC, K45VC, K45RC	ND
KXLC, KRXLC	ND
KLC, KRLC	CD
RO	ND
BOSC	ND
CLAC	ND
KILOC, KILORC	ND

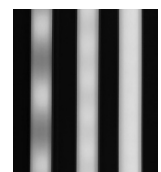

**CD** - Clear Dotting  
**SD** - Slight Dotting  
**ND** - No Dotting

**Installation**

All mounting channels are field cuttable using miter saw with circular blade suitable for cutting aluminum.

**Ordering**

Extrusions are sold separately. View respective specsheets for details on ordering extrusions and their accessories (endcaps, mounting brackets, etc).

## Power Consumption

Tested at full power with PDC Series power supplies.

Nominal Length	LLRGB42			
	SO		HO	
	W/ft	Total wattage	W/ft	Total wattage
<b>1</b>	4.4	4.4	8.6	8.6
<b>2</b>	4.5	8.9	8.3	16.6
<b>3</b>	4.4	13.0	8.3	24.2
<b>4</b>	4.5	17.5	8.3	32.7
<b>5</b>	4.4	21.7	8.1	39.8
<b>6</b>	4.4	26.9	8.1	49.0
<b>7</b>	4.3	30.7	7.9	56.2
<b>8</b>	4.3	34.7	7.8	62.2
<b>9</b>	4.3	38.6	7.7	69.7
<b>10</b>	4.3	42.6	7.5	74.9
<b>11</b>	4.2	46.3	7.0	77.4
<b>12</b>	4.1	49.3	6.8	81.7
<b>13</b>	4.1	53.6	6.5	84.2
<b>14</b>	4.1	56.6		
<b>15</b>	4.0	59.7		
<b>16</b>	4.0	63.6		
<b>17</b>	3.9	66.9		
<b>18</b>	3.8	69.5		
<b>19</b>	3.8	71.4		
<b>20</b>	3.7	73.6		
<b>21</b>	3.5	73.5		
<b>22</b>	3.4	75.9		
<b>23</b>	3.3	76.8		
<b>24</b>	3.3	77.8		
<b>25</b>	3.2	78.8		
<b>26</b>	3.1	80.6		
<b>27</b>	3.0	81.4		
<b>28</b>	3.0	84.3		

## Voltage Drop Calculator

The below chart assumes nominal voltage of 24 Volts and a Voltage Drop Allowance of 3% through the wire

Wattage [W]	Maximum Wire Length From Power Supply to Start of Run [ft]						
	12 AWG	14 AWG	16 AWG	18 AWG	20 AWG	22 AWG	24 AWG
<b>5</b>	1088.2	684.4	430.3	270.6	170.2	107.1	67.3
<b>10</b>	544.1	342.2	215.1	135.3	85.1	53.5	33.7
<b>15</b>	362.7	228.1	143.4	90.2	56.7	35.7	22.4
<b>20</b>	272.0	171.1	107.6	67.7	42.6	26.8	16.8
<b>25</b>	217.6	136.9	86.1	54.1	34.0	21.4	13.5
<b>30</b>	181.4	114.1	71.7	45.1	28.4	17.8	11.2
<b>35</b>	155.5	97.8	61.5	38.7	24.3	15.3	9.6
<b>40</b>	136.0	85.5	53.8	33.8	21.3	13.4	8.4
<b>45</b>	120.9	76.0	47.8	30.1	18.9	11.9	7.5
<b>50</b>	108.8	68.4	43.0	27.1	17.0	10.7	6.7
<b>55</b>	98.9	62.2	39.1	24.6	15.5	9.7	6.1
<b>60</b>	90.7	57.0	35.9	22.6	14.2	8.9	5.6
<b>65</b>	83.7	52.6	33.1	20.8	13.1	8.2	5.2
<b>70</b>	77.7	48.9	30.7	19.3	12.2	7.6	4.8
<b>75</b>	72.5	45.6	28.7	18.0	11.3	7.1	4.5
<b>80</b>	68.0	42.8	26.9	16.9	10.6	6.7	4.2
<b>85</b>	64.0	40.3	25.3	15.9	10.0	6.3	4.0
<b>90</b>	60.5	38.0	23.9	15.0	9.5	5.9	3.7
<b>96</b>	56.7	35.6	22.4	14.1	8.9	5.6	3.5

## Power Supplies

See fixture and power supply instructions & spec sheet for wiring information. Dimming possible in select models - view Luminii website for list of compatible dimmers.

### DMX Dimming Power Supplies 120VAC - 277VAC

MODEL	POWER	OUTPUT
PSDMX - DMX Power Supply	96 - 96 Watt 3X96 - 3 X 96 Watt	24 - 24 VDC

PSDMX - DMX Power Supply dims down to 0%

Features eldoLED's LINEARdrive configurable dimmable drivers

\*With controller only

MODEL	96W	3X96
Length	14.40"	13.00"
Width	5.20"	6.62"
Depth	2.60"	4.20"

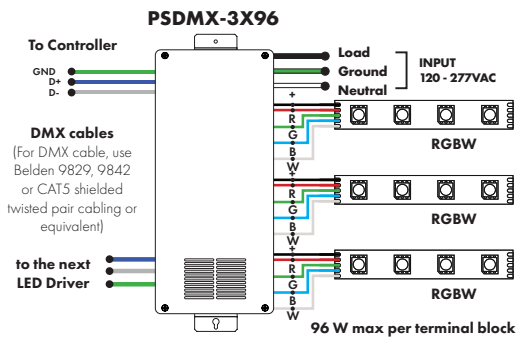
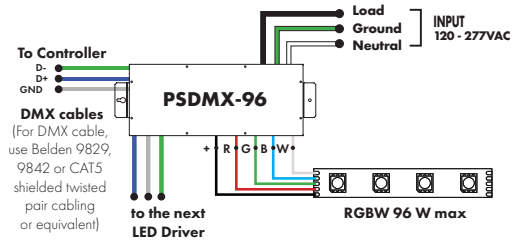

### Non-Dimming Power Supply 120VAC - 277VAC

MODEL	POWER	OUTPUT	DIMMING	LOCATION
PSV - PSV Series	96 - 96 Watt	24 - 24 VDC	ND - Non Dimming	D - Dry location

Requires a controller and a decoder to work properly

MODELS	96W
Length	8.25"
Width	3.75"
Depth	1.63"

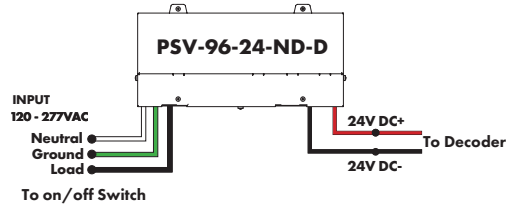

## Decoders



DMX512 decoder with RDM functionality features 5 PWM output channels with common anode. High PWM output frequency range allows the product to be used in HD video conferencing spaces. All DMX products to be installed per DMX512 Standard.

**Power**  
96 Watt

**Inputs**  
RJ45, XLR-5Pin, Terminal Block

**DMX Channels**  
1 to 5 settable

**PWM Output Resolution Ratio**  
8 or 16 bit

**PWM Output Frequency**  
500Hz - 30KHz

**Output Dimming Curve Gamma Value**  
0.1 ~ 9.9

MODEL

**DDMX-5CH-RDM-PRO**

DDMX-5CH-RDM-PRO-DMX512 Decoder

## Decoders



MODEL

DDMX-RGBW

DDMX-RGBW - DMX512 Decoder

Translates controller DMX512 programs for RGB and white LED strips.

Unique DMX address for the decoder can be set easily and displayed by the numeric display on the case. Changing and resetting the DMX address requires manual input.

Use power repeater to expand output (Luminii part# RGBW-SR).

**Operating Voltage**  
12-36 VDC

**Power Capacity**  
up to 96W at 24V

**Operating Temperature Range**  
from -4°F to +122°F in case

**PWM Output Frequency**  
200Hz or 1500Hz



MODEL

RGBW-MC3

RGBW-MC3-4-zone RGBW controller

Easy to operate wireless interface suitable for static or color changing scenes. Control 4 different color zones separately or at the same time. RGBW receiver (RGBW-RC-R) required for operation. Assign multiple receivers per zone to cover a large area.

Color wheel enables highly stable and sensitive color control functionality. Create your own color changing sequences with ease and flexibility.

**Power**  
qty 3 AAA batteries

**Scenes**  
up to 4 unique zones

**Signal**  
Wireless (RF)

**Energy Saving**  
Deactivates after 10 seconds of inactivity

**Color Parameters**

- Brightness
- Saturation
- Primary colors
- Speed of color changing sequence
- Fading



MODEL

RGBW-RC-R

RGBW-RC-R - RGBW receiver

The RGBW receiver is easily paired with controller by the click of a button. Receiver can be reset to factory settings at any time.

Each receiver can store one static RGB color, one color sequence, and one brightness setting for the white LED strip. Receivers assigned to the same scene within the same zone will have the same LED static color and color sequence.

**Operating Voltage**  
12-36 VDC

**Power Capacity**  
up to 96W at 24V

**Operating Temperature Range**  
from -4°F to +122°F in case

## Decoders



MODEL

### RGBW-SR

RGBW-SR - RGBW signal repeater

Extends identical signal when connected in series to an RGBW LED control system. The RGBW signal repeater works with Luminii RGB and RGBW controllers, receivers, and decoders.

RGBW signal can be extended indefinitely when adequate power supply (not included) is connected to the system.

**Operating Voltage**  
12-36 VDC

**Power Capacity**  
up to 96W at 24V

**Operating Temperature Range**  
from -4°F to +122°F in case



MODEL

### RGBW-WI-R

RGBW-WI-R - WIFI generator

RGBW-WI-R creates a local network that enables any electronic device (phone, tablet, etc.) to control the RGB/W strip connected to a RGBW-RC-R receiver.

The control functions are achieved through a free application download for Android and iOS devices called REALCOLOR.

**Operating Voltage**  
12-36 VDC

**Power Supply**  
PI-130-24 (included)

**Operating Temperature Range**  
from -4°F to +122°F in case



MODEL

### TSDMX-E

TSDMX-E - Touchscreen DMX controller

Programmable advanced DMX512 lighting controller featuring a touch-screen interface. Operates as stand alone controller or integrated with most architectural lighting control systems. Can controller endless DMX512 enabled devices.

Mounts to standard single or dual gang wall box with the included power supply inside the junction box. Terminal block design for power and data connections.

#### Features

- Sleek glass design which sits 0.43" from the wall
- Graphical color display to show selected environment
- Color/dimmer/speed palette
- Color temperature mixing
- Touch sensitive buttons. No mechanical parts
- Touch sensitive wheel allows for accurate color selection
- Multi-zone microSD memory
- Multi-room control with 500 scenes, 10 zones
- 1024 DMX channels. Control 340 RGB fixtures
- USB & Ethernet connectivity for programming and control

#### Power Supply

7 VDC (included)

#### Programmability

PC, Mac, Tablet, Smartphone

#### Output Signal

DMX512 (1024 channels)

#### Color Parameters

- Brightness
- Saturation
- Speed of color changing sequence
- Fading / dimming / brightness



**Decoders**



DMX /Wireless RGB-W wall-mount controller controls DMX lighting fixtures, wireless control of RGB-W lighting fixture or use both simultaneously. Fits in any standard US switch box. Includes all the outputs in the back of the controller. Control brightness levels with a single touch, personalize and memorize 3 different scenes, and even create 3 variations of white.

**Features**

- 2 in 1 in-Wall Controller: DMX Control or Wireless RGB-W
- 65,000 Color Options, Dimming and Speed Control
- Memory Function
- 50 Foot Wireless Range
- Easily Fits Standard US Switch Boxes
- Touch Sensitive Glass Surface
- Includes 10 Built in Programs, or Create and Play Your Own

**Operating Voltage**

12 - 24V DC

**Color Parameters**

- Brightness
- Saturation
- Primary colors
- Fading
- Color changing speed

MODEL	ZONES	COLOR
DMX-DMX	3Z-3 Zone 1Z-1 Zone	RGBW-Red, Green, Blue, & White