

LETO 44 S A MID

ASYMMETRIC SURFACE MOUNT LED DOWNLIGHT



Leto 44 S A MID - Surface LED Light. Leto 44 S A MID is the asymmetric version of Leto 44 S MID. Middle size of the Leto 44 Family, the Leto 44 S A MID is anything but mediocre. Perfect proportion give this fixture adaptability and easy configuration. Leto 44 S A MID will **NOT** fit over a standard junction box. Requires client supplied reducer ring (TNB 54 C 3) for installation.

Ordering Code

Fixture	704A		--					
	1	2	3	4	5	6	7	8
Driver				--	--			
	1	2	3	4	5			

Product Specifications

SAMPLE: Fixture **704A - A90 - --- 27 - 07 - DL - 08 - 01** | Driver **910 - STD - 120 - A90 - 07**

1 - Model	2 - LED	3 - Optic	4 - CCT	5 - Lumen	6 - Accessory	7 - Body Color												
704A · Leto 44 Medium Asymmetric Surface Mount	A90 · 93+ CRI Accuracy	<i>Leto 44 A is equipped with a fixed beam spread. For other optics please contact SENSO.</i>	25 · 2500K 27 · 2700K 30 · 3000K 35 · 3500K 40 · 4000K 65 · 6500K	07 · 700 (6.1W) 10 · 1000 (9.1W) 15 · 1500 (14W)	DL · Diffusing Lens	<table border="0"> <tr> <td><i>Standard</i></td> <td><i>Premium</i></td> </tr> <tr> <td>01 · White</td> <td>52 · Mocha</td> </tr> <tr> <td>02 · Black</td> <td>53 · Charcoal</td> </tr> <tr> <td>08 · Silver</td> <td>54 · Cerulean</td> </tr> <tr> <td></td> <td>55 · Firebrick</td> </tr> <tr> <td></td> <td>XX · RAL</td> </tr> </table>	<i>Standard</i>	<i>Premium</i>	01 · White	52 · Mocha	02 · Black	53 · Charcoal	08 · Silver	54 · Cerulean		55 · Firebrick		XX · RAL
<i>Standard</i>	<i>Premium</i>																	
01 · White	52 · Mocha																	
02 · Black	53 · Charcoal																	
08 · Silver	54 · Cerulean																	
	55 · Firebrick																	
	XX · RAL																	
8 - Baffle Color	1 - Housing	2 - Driver	Dim Level	Dim Level														
<table border="0"> <tr> <td><i>Standard</i></td> <td><i>Premium</i></td> </tr> <tr> <td>01 · White</td> <td>52 · Mocha</td> </tr> <tr> <td>02 · Black</td> <td>53 · Charcoal</td> </tr> <tr> <td>08 · Silver</td> <td>54 · Cerulean</td> </tr> <tr> <td></td> <td>55 · Firebrick</td> </tr> <tr> <td></td> <td>XX · RAL</td> </tr> </table>	<i>Standard</i>	<i>Premium</i>	01 · White	52 · Mocha	02 · Black	53 · Charcoal	08 · Silver	54 · Cerulean		55 · Firebrick		XX · RAL	00 · Integral Driver 910 · Remote Driver Housing	STD · Non Dimming LCS · 0 - 10 Volt Protocol DIM · Phase ^{*1/2} ELDOLC · EldoLED 0 - 10 Volt ^{*2} DALI · Dali Protocol ^{*2}	N/A 1% 1% 0.1% 0.1%	LUTES · Hilume Ecodigital ^{*2} LUT2W · 2 Wire for phase ^{*1/2} DMX · SENSO ^{*2} EMG · Emergency Driver ^{*2/3} CSMB · Casambi Wireless Control ^{*2/3}		
<i>Standard</i>	<i>Premium</i>																	
01 · White	52 · Mocha																	
02 · Black	53 · Charcoal																	
08 · Silver	54 · Cerulean																	
	55 · Firebrick																	
	XX · RAL																	
3 - Voltage	4 - LED	5 - Lumen																
120 · 120V 277 · 277V 347 · 347V ^{*2/4}	Same as Fixture	Same as Fixture	^{*1} 120V only ^{*2} remote mount ^{*3} second driver required ^{*4} not available with ELDO, Lutron or DMX															

LETO 44 S A MID

ASYMMETRIC SURFACE MOUNT LED DOWNLIGHT



Reflector

SENSO metal spun faceted reflectors are specifically designed to retain as much light as possible. This results in a more power efficient fixture with a higher delivered lumen.

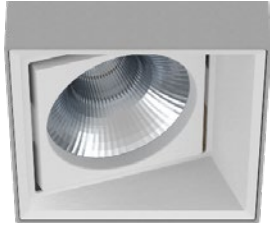

Accessories

Diffusing Lens

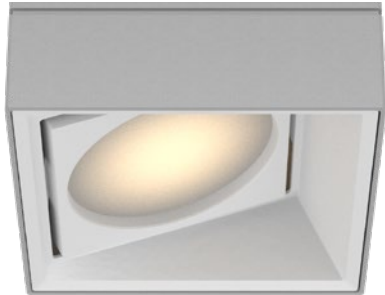

Installation

- Mounting plate included
- Easy, single motion installation method
- Requires client supplied reducer ring (TNB 54 C 3)

Construction / Finish

- High quality, scratch resistant powder coated finish in standard, premium or custom colors
- Aluminum extruded Body
- Made in Canada

Dimensions

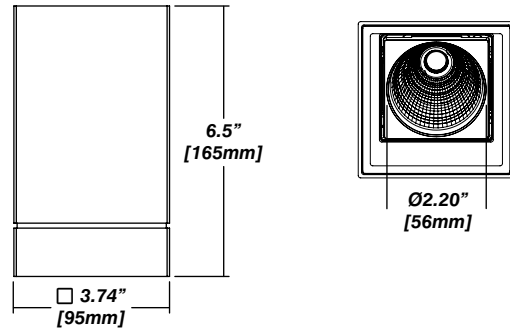

Senso Driver Housings

Single Remote Driver Housing

- Fits Standard, LCS or DIM drivers
- Galvanized steel enclosure
- For remote driver applications

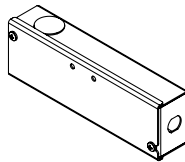

Dimensions

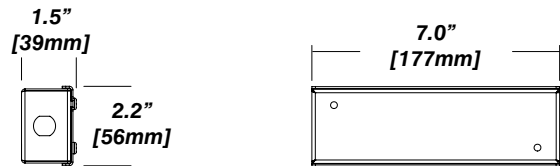

Double Remote Driver Housing

- Fits all drivers
- Galvanized steel enclosure
- For remote driver applications

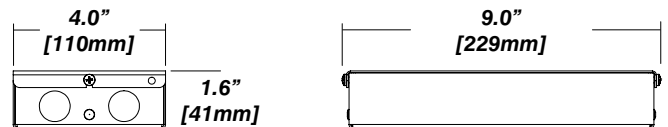
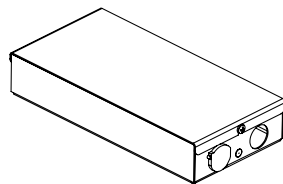

LETO 44 S A MID

ASYMMETRIC SURFACE MOUNT LED DOWNLIGHT



Photometrics

SENSO's in-house photometric testing ensures that our lighting design can match your needs precisely. Our Goniophotometer and testing lab produces on-demand photometry files based on any specified fixture, including LM-79 Test reports, IES Files, and CRI/CCT measurements. See SENSOlighting.com for more information.

**Full photometric Reports and IES files available for every configuration*

LED Module Performance

Output: Up to 113 lumen/Watt

Efficacy: Color consistency within a 3-MacAdam Ellipse

CCT: 2500K - 6500K

Color Rendering: 93+ CRI

Min. R Values: R⁹ - 60 R¹ - 90 R⁰ - 100

Driver and Power Consumption

Dimming: 1% dimming standard with 0.1% option
Casambi wireless control available

Ripple: Industry leading Low ripple

Efficiency: Power Factor >0.9

Efficiency over 85%

Class 2 output for safety

Installation: Fixture body or remote mounted

Lumen Option	700lm	1000lm	1500lm
Fixture Wattage	6.1W	9.1W	14W
Delivered Lumen	691lm	1018lm	1513lm

Color Metrics

TM 30-15

Our clients deserve the best information possible about their lighting choices. That's why SENSO has invested in the Illuminating Engineering Society (IES) TM 30-15, a new system that measures an LED light source's color rendering properties. Using SENSO's state-of-the-art goniophotometer, this method identifies the optimal light source for your project and helps evaluate the trade-offs between efficacy and color rendering. SENSO can provide TM 30-15 data for all of our products.

**Full Color Metric Info Available at SENSOlighting.com*