

LETO 11 Mini WM

WALL MOUNT LED DOWNLIGHT



Leto 11 Mini WM - Wall Mount LED Downlight. Leto 11 Mini WM is a small wall mounted cylinder LED fixture designed to provide a space with discrete direct lighting. It is the perfect solution for creating subtle light in your space.

Ordering Code

Fixture	652								
	1	2	3	4	5	6	7	8	9
Driver					--	--			
	1	2	3	4	5	6			

Product Specifications

SAMPLE: Fixture **652 - S - A90 - 617 - 27 - 07 - 08 - 02** | Driver **951 - 01 - STD - 120 - A90 - 07**

1 - Model	2 - Size	3 - CRI/LED	4 - Optic	5 - CCT	6 - Lumen	7 - Accessory
652 • Leto 11 Mini Wall Mount	S • Small (73mm) M • Medium (209mm) L • Large (346mm)	A90 • 93+ CRI Accuracy	617 • 17° 624 • 24° 660 • 60°	25 • 2500K 27 • 2700K 30 • 3000K 35 • 3500K 40 • 4000K 65 • 6500K	07 • 700 (6.1W) 10 • 1000 (9.1W) 15 • 1500 (14W)	00 • No Accessory DL • Diffusing Film HO • Honeycomb**

8 - Body Color		9 - Baffle Color		1 - Canopy Style	2 - Canopy Color	
<i>Standard</i>	<i>Premium</i>	<i>Standard</i>	<i>Premium</i>	955 • Round Slim 965 • Square Slim 954 • Round Semi-Recessed	<i>Standard</i>	<i>Premium</i>
01 • White 02 • Black 08 • Silver	52 • Mocha 53 • Charcoal 54 • Cerulean 55 • Firebrick BZ • Bronze WN • Warm Nickel AB • Aged Brass XX • RAL	01 • White 02 • Black 08 • Silver	52 • Mocha 53 • Charcoal 54 • Cerulean 55 • Firebrick BZ • Bronze WN • Warm Nickel AB • Aged Brass XX • RAL		01 • White 02 • Black 08 • Silver	52 • Mocha 53 • Charcoal 54 • Cerulean 55 • Firebrick BZ • Bronze WN • Warm Nickel AB • Aged Brass XX • RAL

3 - Driver		4 - Voltage		5 - CRI/LED	6 - Lumen
STD • Non Dimming*5	N/A	120 • 120V		Same as Fixture	Same as Fixture
LCS • 0 - 10 Volt Protocol*5	1%	277 • 277V			
DIM • Phase*2/5	1%	347 • 347V*3/4			
ELDOLC • EldoLED 0 - 10 Volt*3	0.1%				

*1 accessories not available with small size

*2 120V only

*3 remote mount

*4 not available with DALI or Lutron drivers

*5 Can be junction box mounted with **955** and **965**. See page 2 for details.

LETO 11 Mini W/M

WALL MOUNT LED DOWNLIGHT



LED Module Performance

- Output:** up to 1500lm
- High Efficacy:** up to 110 lumen/Watt
- Color Options (CCT):** 2500K, 2700K, 3000K, 3500K, 4000K, 6500K
- Color Consistency:** Range within a 3-MacAdam Ellipse
- Color rendering (CRI):** 93+ CRI & 50+ R9 Value

Driver and Power Consumption

- Dimming:** 1% dimming standard with 0.1% option
- Ripple:** Industry leading Low ripple
- Efficiency:** Power Factor >0.9
Efficiency over 85%
Class 2 output for safety

Lumen Option	700lm	1000lm	1500lm
Delivered Lumen	668lm	1002lm	1441lm
Fixture Wattage	6.1W	9.1W	14W

Installation

- Pre-assembled for quick installation
- Low profile against the wall gives a floating appearance

Construction

- Machined aluminum construction
- Powder coated in standard or premium finishes
- Made in Canada

Dimensions

L - Large

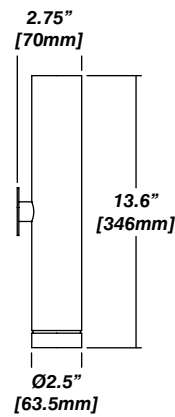

M - Medium

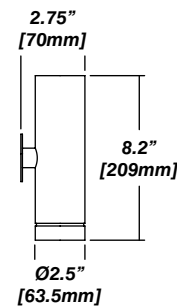

S - Small

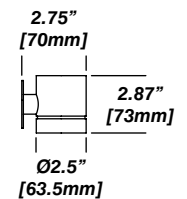

Driver Placement

- **Standard, LCS, and Phase dimming** drivers may be mounted in the junction box.
- Minimum volume required to mount drivers in junction box:
70mm x 40mm x 30mm

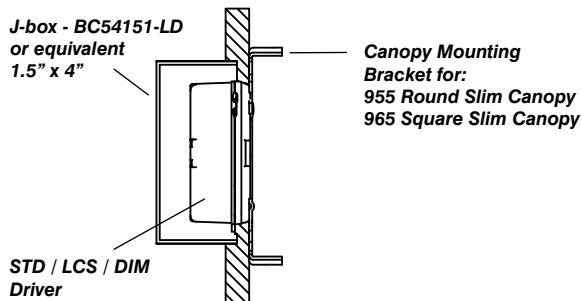

LETO 11 Mini W/M

WALL MOUNT LED DOWNLIGHT

Accessories

Diffusing Film



Honeycomb

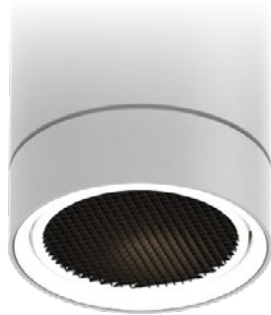

Standard Finishes

01 - White

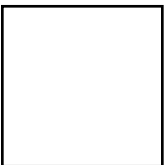

02 - Black

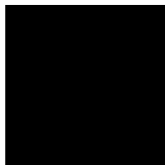

08 - Silver



Premium Finishes

55 - Mocha



56 - Charcoal



57 - Cerulean



58 - Firebrick



BZ - Bronze



WN - Warm Nickel



AB - Aged Brass



Canopy

955 - Round Slim

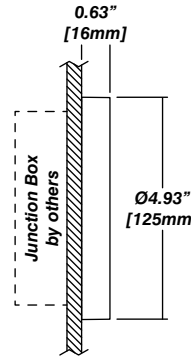

965 - Square Slim

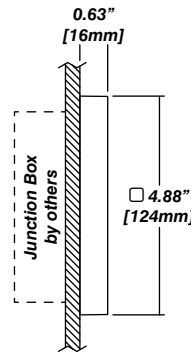

954 - Semi-Recessed +
Cylinder Driver Housing

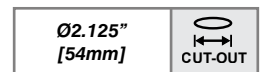
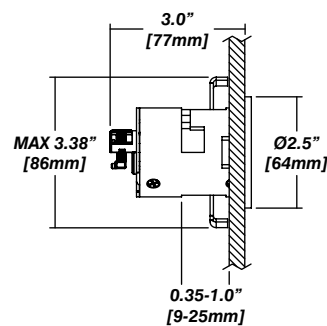

LETO 11 Mini WM

WALL MOUNT LED DOWNLIGHT

Senso Driver Housings

910 - Single Remote Driver Housing

- Fits Standard, LCS or DIM drivers
- Galvanized steel enclosure
- Installed in remote location

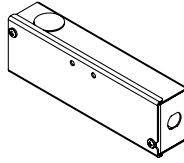

Dimensions

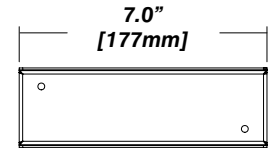
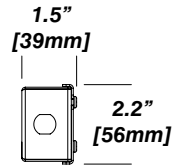

910 - Double Remote Driver Housing

- Fits all drivers
- Galvanized steel enclosure
- Installed in remote location

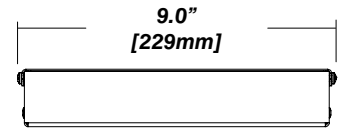
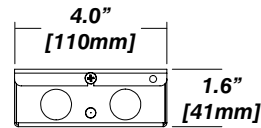
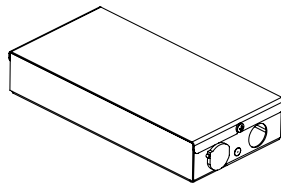

954 - Cylinder Driver Housing

- Supplied standard with every semi-recessed canopy
- Fits Standard, LCS or DIM drivers
- Extruded aluminum enclosure with strain relief to fixture
- Installed in ceiling beside canopy

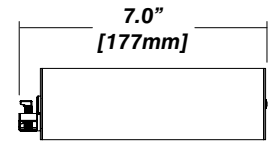
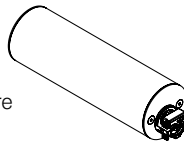

954 Driver Layouts

954 with Cylinder Driver Housing

- Installed in ceiling beside canopy
- Driver mounted inside cylinder
- Dimming control wired from Cylinder Driver Housing

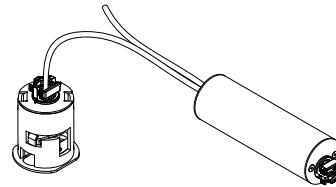

954 with Cylinder Driver Housing

+ 910 Single Driver Housing

- Driver remotely mounted inside 910 housing
- Fed directly to 954 cylinder for DC connections (wire and strain reliefs supplied by others)

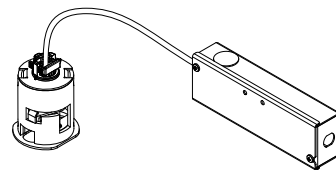

954 with Cylinder Driver Housing

+ 910 Double Driver Housing

- Driver remotely mounted inside 910 housing
- Fed directly to 954 cylinder for DC connections (wire and strain reliefs supplied by others)

