

LETO 11

SURFACE MOUNT WET LED CYLINDER

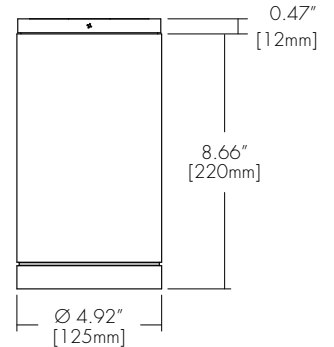

Features

- Faceted and Smooth metal reflectors provide beam spreads between 10° to 80°.
- Nine drivers selections available to cover wide range of applications.
- Four output options available up to 2000 lumens.
- 5 year warranty.

Finish Options

- White
- Black
- Silver
- Mocha
- Charcoal
- Cerulean
- Firebrick



Technical Information

OUTPUT OPTIONS	700 lm	1000 lm	1500 lm	2000 lm
Fixture wattage	6.1 W	9.1 W	14.0 W	19.8 W
Delivered Lumen at 3500K	656 lm	994 lm	1457 lm	1991 lm
Efficacy	108 lm/W	109 lm/W	104 lm/W	101 lm/W
Center Beam Candlepower (10° Faceted Reflector)	5474 cd	8294 cd	12157 cd	16613 cd

CCT	Multiplier	CRI	TM-30		
			R _f	R _g	R ₉
2500K	0.81	92	90	104	77
2700K	0.92	92	91	102	61
3000K	0.97	95	92	102	61
3500K	1.00	95	93	101	72
4000K	1.07	95	92	103	68
6500K	1.05	96	91	100	89

Integral Driver Example: Fixture LET11W-SM-07-25K-F10-CL-WH-WH-PHSD-NA
 Remote Driver Example: Fixture LET11W-SM-07-25K-F10-CL-WH-WH-010L-NA
 HRM-LET11W-SM-07-25K-010L-NA

Ordering Code

Fixture

MODEL	TYPE	OUTPUT	CCT	OPTIC	ACCESSORY	BODY FINISH	BAFFLE FINISH
LET11W-Leto 11 Wet	SM-Surface Mount	07-700 lumens (6.1W) ¹ 10-1000 lumens (9.1W) 15-1500 lumens (14.0W) 20-2000 lumens (19.8W)	25K-2500K 27K-2700K 30K-3000K 35K-3500K 40K-4000K 65K-6500K	F10-10 Degree, Faceted F18-18 Degree, Faceted F30-30 Degree, Faceted F45-45 Degree, Faceted F60-60 Degree, Faceted S30-30 Degree, Smooth S45-45 Degree, Smooth S80-80 Degree, Smooth	CL-Clear Lens DL-Diffusing Lens	Standard WH-White BK-Black SL-Silver Premium ² MA-Mocha CC-Charcoal CR-Cerulean FB-Firebrick	Standard WH-White BK-Black SL-Silver Premium ² MA-Mocha CC-Charcoal CR-Cerulean FB-Firebrick

DRIVER³

DRIVER OPTIONS⁵

PHSD - Forward/Reverse Phase, 1% Dimming, 120V Only
 O10S - 0-10V, 1% Dimming, 120/277V
 O103 - 0-10V, 1% Dimming, 347V Only
 O10L - EldoLED, 0-10V, Linear, 0.1% Dimming, 120/277V
 O10G - EldoLED, 0-10V, Log, 0.1% Dimming, 120/277V
 DALI - EldoLED, Dali Protocol 2, DT-6, 0.1% Dimming, 120/277V
 DALI8 - EldoLED, Dali Protocol 2, DT-8, 0.1% Dimming, 120/277V
 LUTE - Lutron Hilume Ecodigital, 1% Dimming, 120V/277V
 DMX - EldoLED, DMX, 0.1% Dimming, 120V/277V

NA - None
 EMG - Emergency Driver⁴

1 - 700 lumens is not available with LUTE driver.
 2 - Premium finishes may have extended lead times. Custom RALs are available, please consult Inside Sales with specific request.
 3 - All drivers remote except PHSD/O10S driver options.
 4 - Emergency option comes prewired from factory with driver in remote housing. 8W of continuous power provided for a minimum of 90 minutes. Must be installed within 30 feet of luminaire using 18 AWG wire. Not available with O103, DMX, DALI8 or LUTE Driver.
 5 - AWWNR/CSMB available upon request, contact Senso for details.

CONTACT FACTORY FOR MORE OPTIONS.

Lens & Accessory Options

OPTC-ACC-CL-94MM

Clear Lens

Also available with complete fixture, use ordering code.

-CL



Light Loss Factor: 100%*

OPTC-ACC-DL-94MM

Diffusing Lens

Also available with complete fixture, use ordering code.

-DL



Light Loss Factor: 87%*

*Light Loss Factor calculated with 60° faceted reflector.

Optics

RFLC-FXX-94MM

Faceted Reflector

Also available with complete fixture, use ordering code.

-F10/-F18/-F30/-F45/-F60



RFLC-SXX-94MM

Smooth Reflector

Also available with complete fixture, use ordering code.

-S30/-S45/-S60



FXX	Optic
F10	10° Faceted
F18	18° Faceted
F30	30° Faceted
F45	45° Faceted
F60	60° Faceted
S30	30° Smooth
S45	45° Smooth
S60	60° Smooth

Remote Driver Housing

Depending on the options selected in the order code on page 1, a Remote Driver Housing may be required. This will automatically be generated and put on your order as necessary.

REMOTE DRIVER	MODEL	CCT	OUTPUT	DRIVER	DRIVER OPTIONS
HRM-Housing, Remote	LET11W-SM - Leto 11 Wet Surface Mount	Same as Fixture	Same as Fixture	Same as Fixture	Same as Fixture

Maximum mounting distance to luminaire using 18 AWG wire						
010S	PHSD	010L	010G	DALI DALI8	DMX	LUTE
16'	16'	72'	72'	72'	149'	15'

HRM Single with Externally Mounted Driver

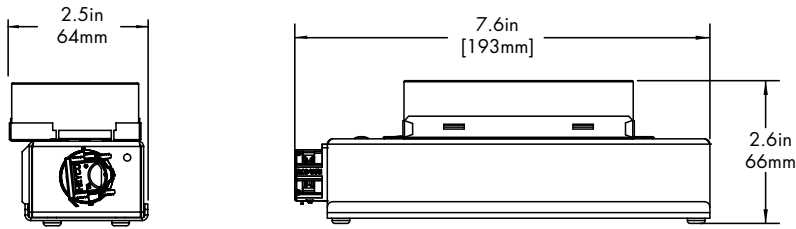

Driver
010L or 010G
010S
010L or 010G or 010S
DALI or LUTE

HRM Single

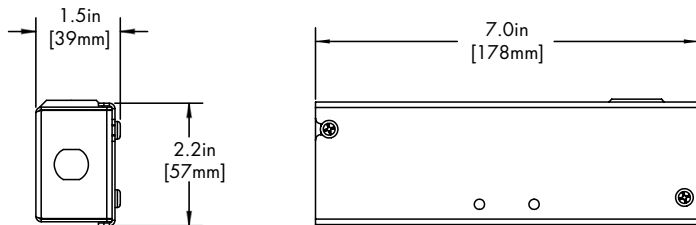

Driver
PHSD

HRM Double

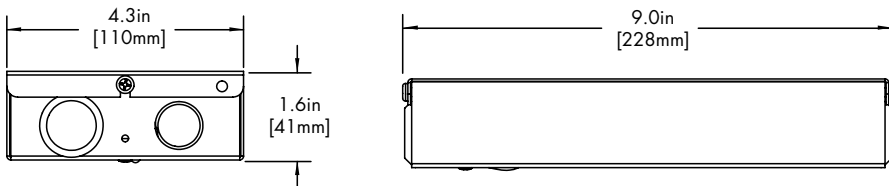

Driver
DALI8
DMX

EMG Emergency Driver

120 minute EMG operation time.

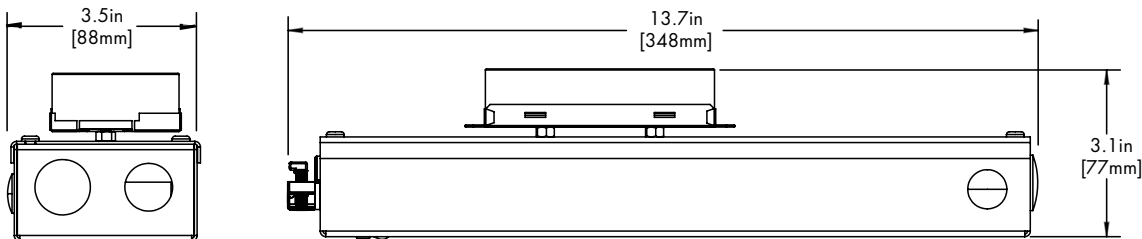

Driver
EMG

LETO 11

SURFACE MOUNT WET LED CYLINDER

Standard Colors

BK
Black



WH
White



SL
Silver

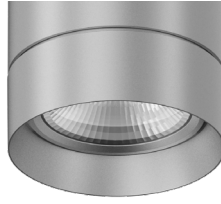

Premium Colors

MA
Mocha

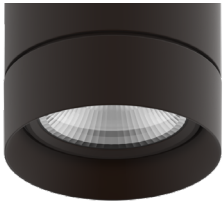

CC
Charcoal

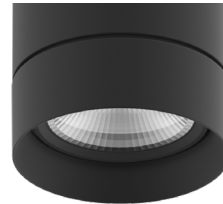

CR
Cerulean

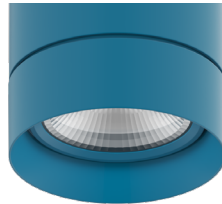

FB
Firebrick

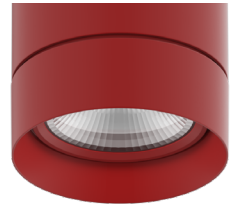

Two Tone Finishes

Inside finish refers to Baffle Finish selection from page 1. Any combination may be used for baffle and body finishes.

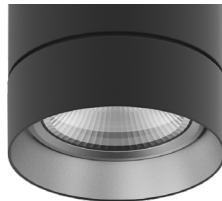
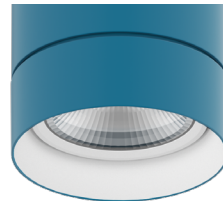
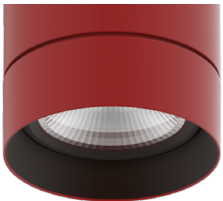

TM-30

2500K

COLOR VECTOR GRAPHIC

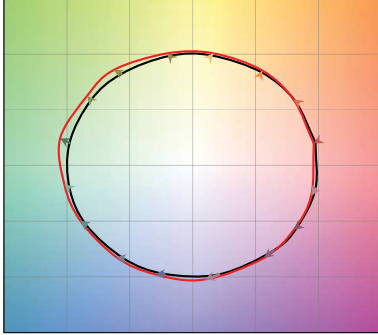

— Reference Source — Test Source

2700K

COLOR VECTOR GRAPHIC

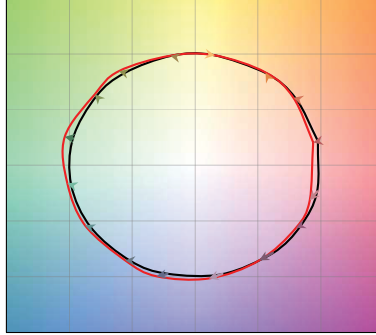

— Reference Source — Test Source

3000K

COLOR VECTOR GRAPHIC

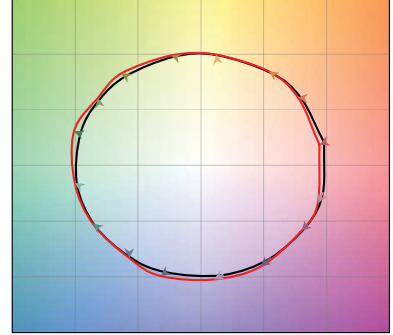

— Reference Source — Test Source

3500K

COLOR VECTOR GRAPHIC

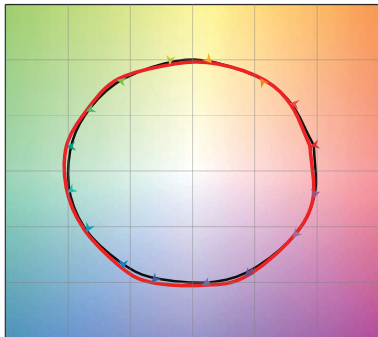

— Reference Source — Test Source

4000K

COLOR VECTOR GRAPHIC

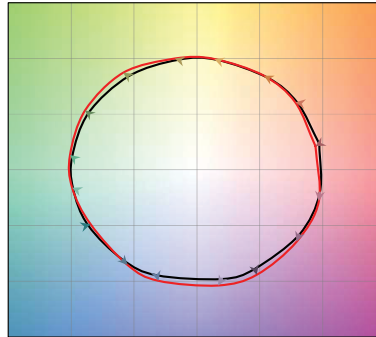

— Reference Source — Test Source

6500K

COLOR VECTOR GRAPHIC

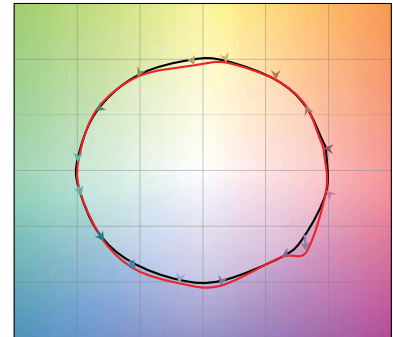

— Reference Source — Test Source

Photometry

10° Faceted Reflector

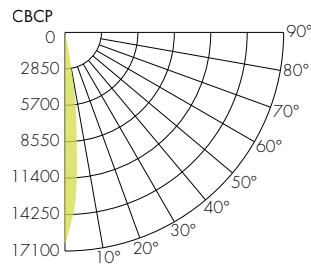
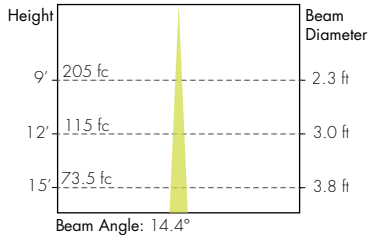

30° Smooth Reflector

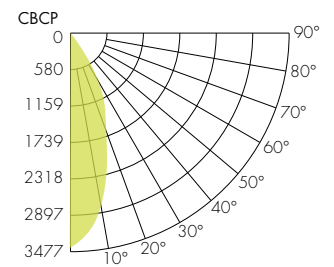
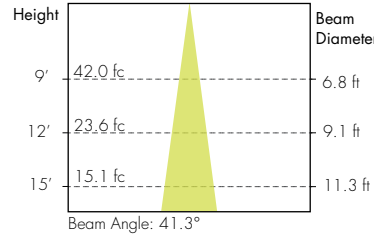

18° Faceted Reflector

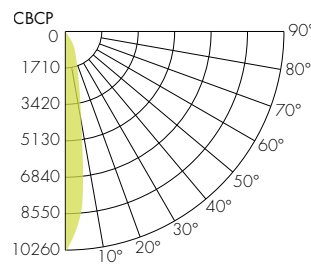
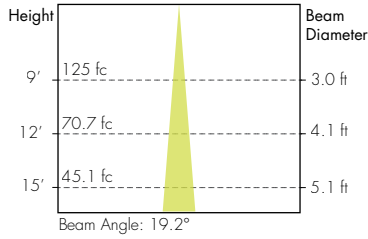

45° Smooth Reflector

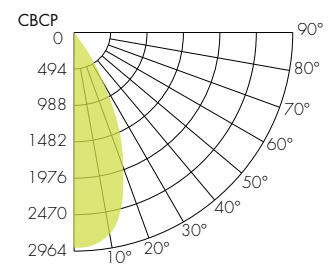
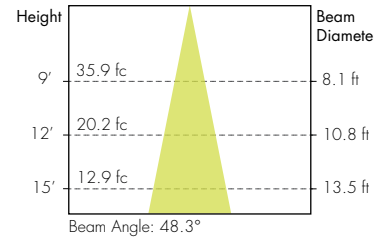

30° Faceted Reflector

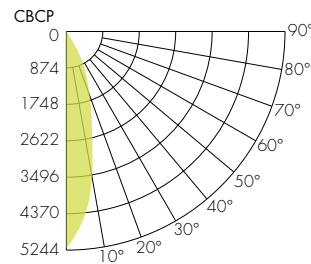
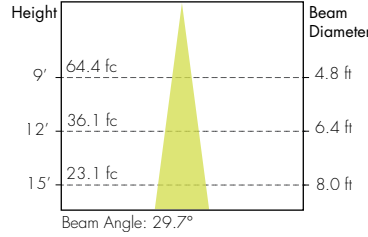

80° Smooth Reflector

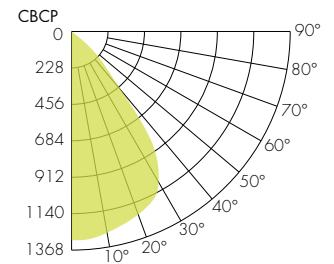
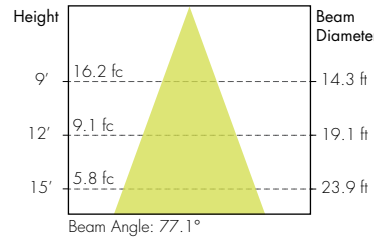

45° Faceted Reflector

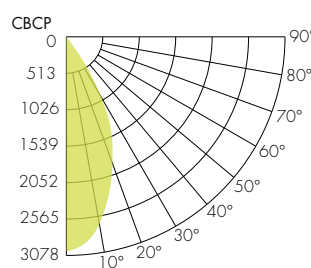
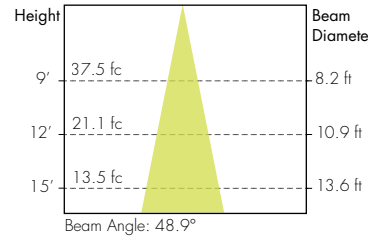

60° Faceted Reflector

