

Features

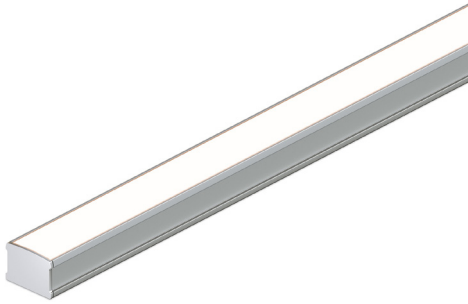

- 24VDC Class 2 and IP68 rated for wet locations, fixtures made to order up to 144". Fixtures can be linked up to 48' depending on output
- Suitable for undercabinet, millwork, surface mount, direct view, cove, outdoor, wet, architectural reveals, and accent lighting applications
- Dot free even illumination with frosted lens
- High Color Quality options offer premium quality and vibrant colors with R9 values up to 97
- High Efficacy options offer best in class output and efficacy with over 590 lm/ft and over 80 lm/W
- Proprietary strong bond solder method handles up to 50 lbs of pull force on wire leads and connectors
- 3 Year warranty

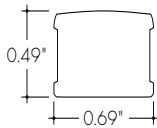

Finish Options (see page 2 for additional information)

- | | | |
|-----------------|-------------|---------------|
| Silver Anodized | White | Aged Brass |
| Black | Matte Black | Polished Gold |
| Bronze | Warm Nickel | Chrome |



Technical Information

MODEL	High Color Quality			High Efficacy				High Efficacy
	72SO	72HO	72VHO	HE48LO	HE48SO	HE48MO	HE48HO	HE64VHO
OUTPUT OPTIONS								
Lumens Output (3000K) <small>(with a Clear Lens)</small>	163 lm/ft	265 lm/ft	323 lm/ft	159 lm/ft	220 lm/ft	294 lm/ft	472 lm/ft	597 lm/ft
Average Power Consumption <small>(for a 4" section)</small>	2.8 W/ft	4.8 W/ft	6 W/ft	1.9 W/ft	2.8 W/ft	3.5 W/ft	6.5 W/ft	7.5 W/ft
Efficacy	58 lm/W	55 lm/W	54 lm/W	84 lm/W	79 lm/W	84 lm/W	73 lm/W	80 lm/W
Max Run Length <small>(in series)</small>	40 ft	31 ft	22 ft	48 ft	42 ft	33 ft	21 ft	15 ft
Max Ambient Temperature*	50°C [122°F]		48°C [118°F]	50°C [122°F]		45°C [113°F]		39°C [102°F]

*Max Ambient Temperature to maintain L70 of 50k+ hours. Exceeding Max Ambient Temperature may result in decreased life/output. Consult Technical Support for specific inquiries.

High Color Quality (72)

CCT	Multiplier <small>(reference - 3000K)</small>	TM-30			
		CRI	R _f	R _g	R ₉
2700K	0.97	97	96	99	93
3000K	1.00	96	95	99	92
3500K	1.01	96	95	100	94
4000K	1.34	97	96	102	92

High Efficacy (HE48/HE64)

CCT	Multiplier <small>(reference - 3000K)</small>	TM-30			
		CRI	R _f	R _g	R ₉
2700K	0.94	92	90	99	46
3000K	1.00	92	89	99	62
3500K	1.02	92	89	99	58
4000K	1.02	92	86	94	52

Ordering Code

MODEL	LENGTH ¹	OUTPUT	CCT	LENS ²	MOUNTING	FINISH ³	POSITION	POWER FEED	ACCESSORIES
KMW - Kendo M Wet	12" - 144" 1" increments	72SO - Standard 72HO - High 72VHO - Very High	27K - 2700K 30K - 3000K 35K - 3500K 40K - 4000K	C - Clear F - Frosted GR - Narrow Beam Grazer	FC - Fixed Clip A - Adjustable Hinge Mounting FC45 - Fixed Clip 45° EFC - Tamper Resistant Fixed Clip	SA - Silver Anodized BK - Black BZ - Bronze WH - White MB - Matte Black WN - Warm Nickel LB - Light Brass PG - Polished Gold ⁴ CH - Chrome ⁴	E - End B - Back S - Side	1 - 72" wire leads IX2 - 72" wire leads at both ends 2 - 72" wire leads at one end and Quick Connect at other 3 - Single Quick Connect 4 - Quick Connect at both ends	--- - N/A, leave blank BLS - Blade louver, Silver BLBK - Blade louver, Black BLWH - Blade louver, White GSS - Glare shield, Silver GSBK - Glare shield, Black GSWH - Glare shield, White
	12" - 144" 2" increments	HE48LO - Low HE48SO - Standard HE48MO - Medium HE48HO - High HE64VHO - Very High	27K - 2700K 30K - 3000K 35K - 3500K 40K - 4000K						

1 - Custom lengths and increments are available, please consult Inside Sales with specific request.
2 - All High Efficacy options can be used to comply with Title 24 JA8. High Color Quality options can be used to comply with Title 24 JA8 depending on Output, CCT, and lens selections, see multiplier charts to calculate specific efficacies.

3 - Non SA finishes may have extended lead times. Custom RALs are available, please consult Inside Sales with specific request.
4 - Polished Gold finishes have a maximum fixture length of 48", and Chrome finishes have a maximum fixture length of 72".

Product Dimensions

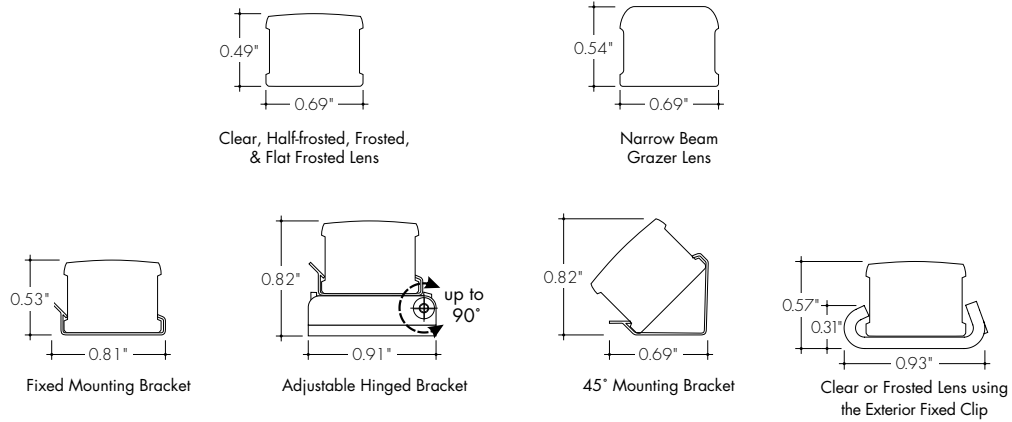

Finish Options

- Finish options are available in a wide variety, allowing for complete customization of style and aesthetic.
- Non Silver Anodized finishes may have extended lead times and price adder.
- Polished Gold and Chrome finishes have a maximum fixture length of 96".
- Custom RALs are available, please consult Inside Sales with specific request.

Silver Anodized Base

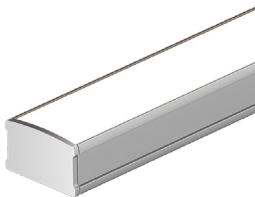

Silver Anodized is a soft silver with a clear finish.

Black Standard



Black is a true deep black with a glossy finish.

Bronze Standard



Bronze is a rich, dark brown with a satin finish.

White Standard



White is a polar bright white and field paintable.

Matte Black Premium



Matte Black is a dark, pitch-black with a soft flat finish.

Warm Nickel Premium



Warm Nickel is a soft, silvery smoke with warm tones and a satin finish.

Aged Brass Premium



Aged Brass is a deep brown shade with slightly golden undertones.

Polished Gold Premium

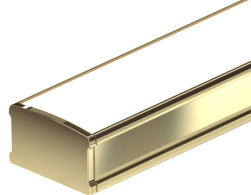

Polished Gold is bright and radiant for a brilliant finish.

Chrome Premium



Chrome is a highly reflective silver polish.

Powerfeeds and Connectors

Linking and Extension Cable Options

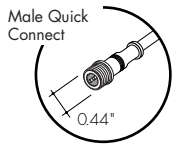

WET-FMA-2-2
Female to Male Adapter, 2 pin

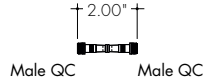

WET-CON-LEAD-M-2-48
Male Wet Connector Cable, 2 pin, 48 inch

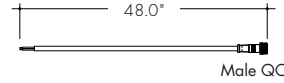

WET-CON-JC-F-M-2-48
Female/Male Wet Jumper Cable, 2 pin, 48 inch

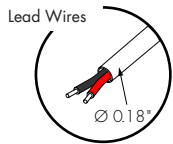
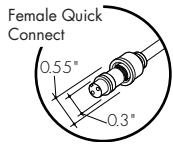
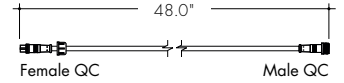

Powerfeeds Position/Type

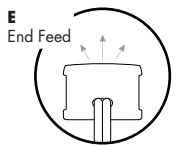

1
72" wire leads



1X2
72" wire leads at both ends

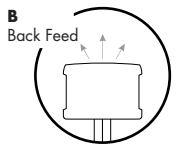

2
72" wire leads at one end and Female Quick Connect at other

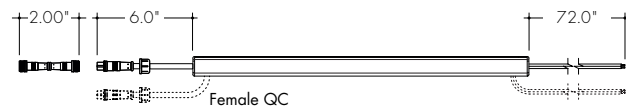

3
Single Female Quick Connect

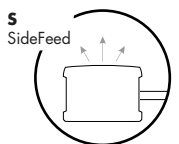
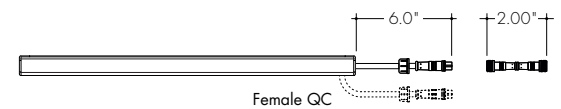

4
Female Quick Connect at both ends



Side and Back feeds shown as dashed lines
All wires are 18 AWG unless otherwise specified
-2, -3, -4 include WetFMA as shown

Sample Layout

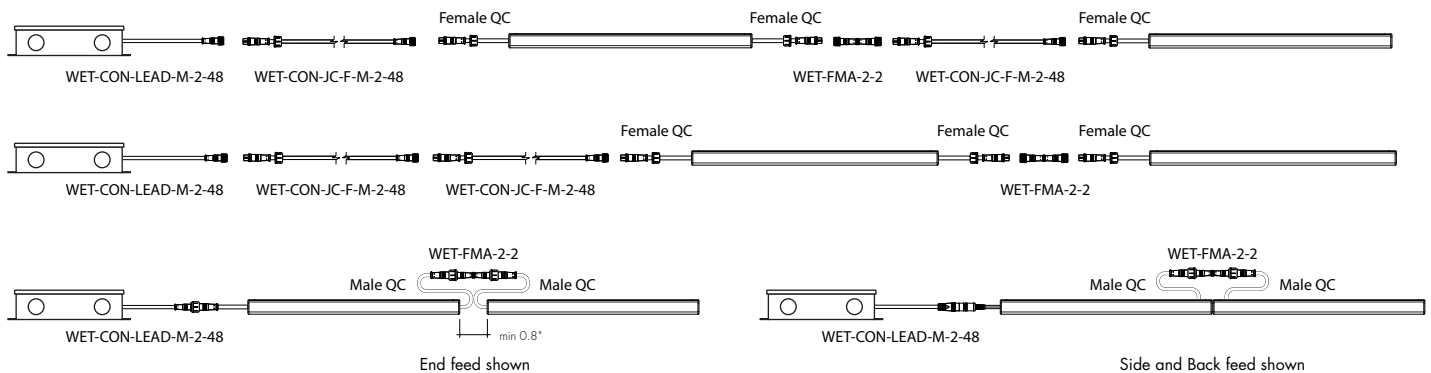

Light Transmission and Dotting

Output Options	Lens/Accessory				
	Clear Lens	Narrow Beam Grazer Lens	Grazer Lens, White Glare Shield	Frosted Lens	Grazer Lens, White Blade Louver
72SO	CD	CD	CD	ND	CD
72HO	CD	CD	CD	ND	CD
72VHO	CD	CD	CD	ND	CD
HE48LO	CD	CD	CD	ND	CD
HE48SO	CD	CD	CD	ND	CD
HE48MO	CD	CD	CD	ND	CD
HE48HO	CD	CD	CD	ND	CD
HE64VHO	CD	CD	CD	ND	CD
Transmission Percentage	100%	87%	63%	49%	47%

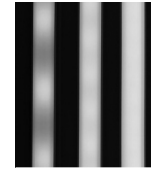

CD SD ND
 CD - Clear Dotting
 SD - Slight Dotting
 ND - No Dotting

Accessory Options

LVSP-WET

Splice box: wet rated, low voltage, gray

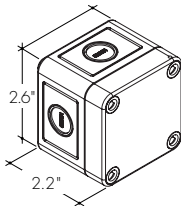

LVSP-WET-CM

Connector for splice box, low voltage for cable management, gray.

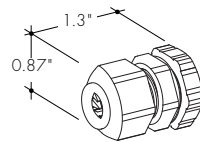

LV-GS-KMSC-24-XX

Glare Shield reduces glare at high angle, field cuttable. Also available with complete fixture, use ordering code **-GSXX**

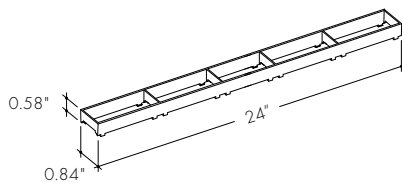

LV-BL-KMSC-24-XX

Blade Louver reduces glare at high angle in two directions. Also available with complete fixture, use ordering code **-BLXX**

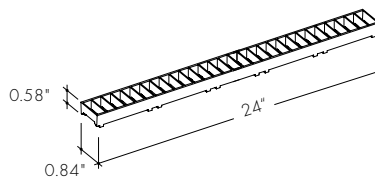

XX	Color
WH	White
BK	Black
SL	Silver

Photometry

KMW-48-72VHO-30K-C

Kendo M Wet, 4ft, 3000K, VHO, Clear Lens

Zonal Lumen Summary 3000K

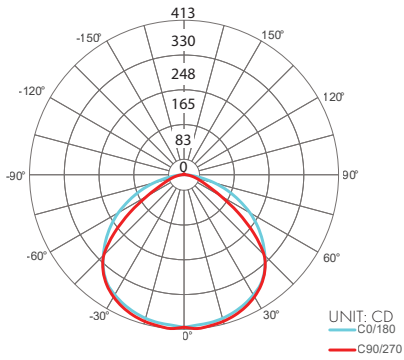

Zone	Lumen	% Fixture
0-30	358	27.7%
0-40	601	46.6%
0-60	1059	82.1%
0-90	1277	98.9%
0-180	1290	100.0%

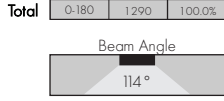

KMW-48-72VHO-30K-F

Kendo M Wet, 4ft, 3000K, VHO, Frosted Lens

Zonal Lumen Summary 3000K

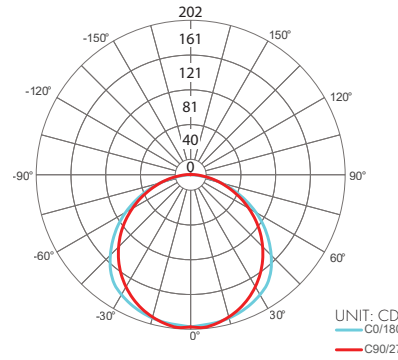

Zone	Lumen	% Fixture
0-30	160	25.4%
0-40	265	42.2%
0-60	478	76.2%
0-90	620	98.7%
0-180	628	100.0%

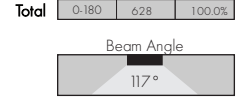

KMW-48-72VHO-30K-GR

Kendo RM Wet, 4ft, 3000K, VHO, Narrow Beam Grazer Lens

Zonal Lumen Summary 3000K

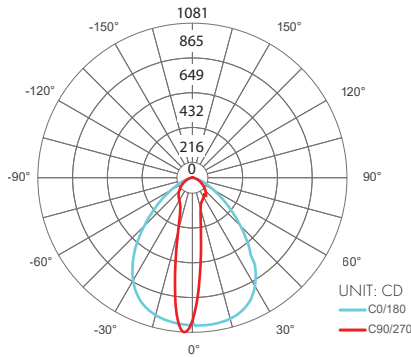

Zone	Lumen	% Fixture
0-30	467	41.7%
0-40	666	59.5%
0-60	971	86.8%
0-90	1104	98.7%
0-180	1118	100.0%

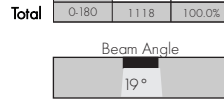

Power Consumption

Tested at Full Power with PDC Series power supplies.

Standard Nominal Lengths offered provide minimal shadowing. For alternate lengths, please contact factory with specific request.

High Color Quality (72)

Nominal Length (in)	Back, Side, and End Feed Actual Length	Watts			Nominal Length (in)	Back, Side, and End Feed Actual Length	Watts			Nominal Length (in)	Back, Side, and End Feed Actual Length	Watts			Nominal Length (in)	Back, Side, and End Feed Actual Length	Watts		
		SO	HO	VHO			SO	HO	VHO			SO	HO	VHO			SO	HO	VHO
12	11 5/16	2.7	4.4	6.2	47	46 1/16	10.2	17.1	22.6	82	81 15/16	18.3	29.5	38.4	117	116 11/16	25.9	40.8	52.4
13	12 7/16	2.7	4.4	6.2	48	47 3/16	10.5	17.4	23.1	83	-	-	-	-	118	117 13/16	26.1	41.1	52.8
14	13 10/16	2.9	4.8	6.7	49	48 6/16	10.7	17.8	23.5	84	83 1/16	18.5	29.8	38.8	119	119	26.3	41.4	53.2
15	14 12/16	3.1	5.2	7.3	50	49 8/16	11.1	18.6	24.4	85	84 4/16	18.7	30.1	39.2	120	-	-	-	-
16	15 15/16	3.4	5.6	7.8	51	50 11/16	11.4	18.9	24.9	86	85 6/16	19.2	30.8	40.0	121	120 2/16	26.5	41.7	53.6
17	-	-	-	-	52	51 13/16	11.6	19.3	25.3	87	86 9/16	19.4	31.1	40.4	122	121 5/16	26.7	42.0	54.0
18	17 1/16	3.6	6.0	8.3	53	53	11.9	19.7	25.7	88	87 12/16	19.6	31.5	40.8	123	122 7/16	27.1	42.6	54.7
19	18 4/16	3.9	6.5	8.9	54	-	-	-	-	89	88 14/16	19.9	31.8	41.1	124	123 10/16	27.3	42.9	55.0
20	19 6/16	4.4	7.3	9.9	55	54 2/16	12.1	20.1	26.1	90	-	-	-	-	125	124 12/16	27.5	43.1	55.4
21	20 9/16	4.6	7.7	10.5	56	55 5/16	12.3	20.5	26.6	91	90 1/16	20.1	32.2	41.5	126	125 15/16	27.7	43.4	55.7
22	21 11/16	4.8	8.1	11.0	57	56 7/16	12.8	21.3	27.4	92	91 3/16	20.4	32.5	41.9	127	-	-	-	-
23	22 14/16	5.1	8.6	11.5	58	57 10/16	13.1	21.6	27.8	93	92 6/16	20.6	32.9	42.3	128	127 1/16	27.9	43.7	56.1
24	-	-	-	-	59	58 12/16	13.3	22.0	28.3	94	93 8/16	21.1	33.6	43.1	129	128 4/16	28.1	43.9	56.4
25	24 1/16	5.3	9.0	12.1	60	59 15/16	13.6	22.4	28.7	95	94 11/16	21.3	33.9	43.4	130	129 7/16	28.5	44.5	57.1
26	25 3/16	5.6	9.4	12.6	61	-	-	-	-	96	95 13/16	21.5	34.2	43.8	131	130 9/16	28.7	44.7	57.4
27	26 6/16	5.8	9.8	13.1	62	61 1/16	13.8	22.8	29.1	97	97	21.8	34.6	44.2	132	131 12/16	28.9	45.0	57.8
28	27 8/16	6.2	10.5	14.1	63	62 4/16	14.0	23.1	29.6	98	-	-	-	-	133	132 14/16	29.1	45.3	58.1
29	28 11/16	6.5	10.9	14.5	64	63 6/16	14.5	23.8	30.5	99	98 2/16	22.0	34.9	44.6	134	-	-	-	-
30	29 13/16	6.7	11.2	15.0	65	64 9/16	14.7	24.1	31.0	100	99 5/16	22.2	35.2	45.0	135	134 1/16	29.3	45.5	58.4
31	31	6.9	11.6	15.5	66	65 12/16	14.9	24.4	31.4	101	100 7/16	22.5	35.9	45.9	136	135 3/16	29.5	45.7	58.7
32	-	-	-	-	67	66 14/16	15.1	24.7	31.9	102	101 10/16	22.7	36.2	46.3	137	136 6/16	29.6	45.9	59.1
33	32 2/16	7.1	12.0	16.0	68	-	-	-	-	103	102 12/16	22.9	36.5	46.7	138	137 8/16	30.0	46.3	59.7
34	33 5/16	7.3	12.3	16.5	69	68 1/16	15.3	25.0	32.4	104	103 15/16	23.1	36.8	47.1	139	138 11/16	30.2	46.5	60.0
35	34 7/16	7.8	13.1	17.4	70	69 3/16	15.5	25.4	32.8	105	-	-	-	-	140	139 13/16	30.3	46.8	60.3
36	35 10/16	8.0	13.4	17.9	71	70 6/16	15.8	25.7	33.3	106	105 1/16	23.3	37.1	47.5	141	141	30.5	47.0	60.6
37	36 12/16	8.2	13.8	18.4	72	71 8/16	16.2	26.3	34.2	107	106 4/16	23.5	37.4	48.0	142	-	-	-	-
38	37 15/16	8.4	14.2	18.9	73	72 11/16	16.4	26.6	34.7	108	107 6/16	23.9	38.1	48.8	143	142 2/16	30.7	47.2	61.0
39	-	-	-	-	74	73 13/16	16.6	26.9	35.1	109	108 9/16	24.1	38.4	49.2	144	143 5/16	30.8	47.4	61.3
40	39 1/16	8.7	14.5	19.3	75	75	16.8	27.3	35.5	110	109 12/16	24.3	38.7	49.6					
41	40 4/16	8.9	14.9	19.8	76	-	-	-	-	111	110 14/16	24.5	39.0	50.0					
42	41 6/16	9.3	15.6	20.7	77	76 2/16	17.1	27.6	35.9	112	-	-	-	-					
43	42 9/16	9.6	16.0	21.2	78	77 5/16	17.3	27.9	36.3	113	112 1/16	24.8	39.3	50.4					
44	43 12/16	9.8	16.4	21.7	79	78 7/16	17.7	28.5	37.2	114	113 3/16	25.0	39.6	50.8					
45	44 14/16	10.0	16.7	22.1	80	79 10/16	17.9	28.9	37.6	115	114 6/16	25.2	39.9	51.2					
46	-	-	-	-	81	80 12/16	18.1	29.2	38.0	116	115 8/16	25.6	40.5	52.0					

Power Consumption

Tested at Full Power with PDC Series power supplies.

Standard Nominal Lengths offered provide minimal shadowing. For alternate lengths, please contact factory with specific request.

High Efficacy (HE48)

Nominal Length (in)	Back, Side, and End Feed Actual Length	Watts				Nominal Length (in)	Back, Side, and End Feed Actual Length	Watts				Nominal Length (in)	Back, Side, and End Feed Actual Length	Watts				Nominal Length (in)	Back, Side, and End Feed Actual Length	Watts			
		LO	SO	MO	HO			LO	SO	MO	HO			LO	SO	MO	HO			LO	SO	MO	HO
12	10 11/16	1.7	2.5	3.5	5.7	47	46 2/16	6.9	10.7	13.3	24.7	82	81 9/16	12.5	19.9	23.9	42.2	117	-	-	-	-	
13	12 11/16	1.7	2.5	3.5	5.7	48	-	-	-	-	-	83	-	-	-	-	-	118	117	17.5	27.7	34.3	58.7
14	-	-	-	-	-	49	48 2/16	7.1	11.2	13.9	25.4	84	83 9/16	12.8	20.3	24.5	43.1	119	119	17.8	28.1	34.9	59.6
15	14 10/16	2.0	3.0	4.0	7.2	50	-	-	-	-	-	85	-	-	-	-	-	120	-	-	-	-	
16	-	-	-	-	-	51	50 1/16	7.4	11.7	14.5	26.3	86	85 8/16	13.1	20.8	25.1	44.1	121	120 15/16	18.1	28.6	35.5	60.5
17	16 10/16	2.4	3.5	4.6	8.7	52	-	-	-	-	-	87	-	-	-	-	-	122	-	-	-	-	
18	-	-	-	-	-	53	52 1/16	7.7	12.3	15.1	27.4	88	87 8/16	13.4	21.3	25.7	45.0	123	122 15/16	18.3	29.0	36.0	62.1
19	18 9/16	2.7	3.9	5.2	10.2	54	-	-	-	-	-	89	-	-	-	-	-	124	-	-	-	-	
20	-	-	-	-	-	55	54	8.0	12.9	15.7	28.5	90	89 7/16	13.7	21.7	26.3	46.0	125	124 14/16	18.4	29.5	36.6	63.8
21	20 9/16	3.0	4.4	5.8	11.7	56	56	8.4	13.5	16.4	29.5	91	-	-	-	-	-	126	-	-	-	-	
22	-	-	-	-	-	57	-	-	-	-	-	92	91 7/16	14.0	22.1	26.9	47.0	127	126 14/16	18.6	29.9	37.2	65.4
23	22 8/16	3.4	4.9	6.4	13.2	58	57 15/16	8.7	14.0	17.0	30.6	93	-	-	-	-	-	128	-	-	-	-	
24	-	-	-	-	-	59	-	-	-	-	-	94	93 6/16	14.3	22.6	27.5	47.9	129	128 13/16	18.8	30.4	37.7	67.0
25	24 8/16	3.7	5.4	7.0	14.7	60	59 15/16	9.0	14.6	17.6	31.6	95	-	-	-	-	-	130	-	-	-	-	
26	-	-	-	-	-	61	-	-	-	-	-	96	95 6/16	14.4	22.8	27.8	48.4	131	130 13/16	18.9	30.8	38.3	68.6
27	26 7/16	4.1	5.9	7.5	15.8	62	61 14/16	9.4	15.2	18.2	32.6	97	-	-	-	-	-	132	-	-	-	-	
28	-	-	-	-	-	63	-	-	-	-	-	98	97 5/16	14.7	23.3	28.5	49.4	133	132 12/16	19.1	31.2	38.9	70.2
29	28 7/16	4.4	6.4	8.1	16.8	64	63 14/16	9.7	15.6	18.7	33.7	99	-	-	-	-	-	134	-	-	-	-	
30	-	-	-	-	-	65	-	-	-	-	-	100	99 5/16	15.0	23.7	29.0	50.4	135	134 12/16	19.3	31.8	39.4	70.7
31	30 6/16	4.8	6.9	8.7	17.9	66	65 13/16	10.0	16.1	19.2	34.7	101	-	-	-	-	-	136	-	-	-	-	
32	-	-	-	-	-	67	-	-	-	-	-	102	101 4/16	15.3	24.1	29.6	51.3	137	136 11/16	19.5	32.3	40.0	71.2
33	32 6/16	5.0	7.2	9.0	18.5	68	67 13/16	10.4	16.5	19.8	35.7	103	-	-	-	-	-	138	-	-	-	-	
34	-	-	-	-	-	69	-	-	-	-	-	104	103 4/16	15.6	24.6	30.2	52.3	139	138 11/16	19.8	32.8	40.6	71.8
35	34 5/16	5.4	7.7	9.6	19.5	70	69 12/16	10.7	17.0	20.3	36.7	105	-	-	-	-	-	140	-	-	-	-	
36	-	-	-	-	-	71	-	-	-	-	-	106	105 3/16	15.8	25.0	30.7	53.2	141	140 10/16	20.0	33.3	41.1	72.3
37	36 5/16	5.7	8.2	10.2	20.6	72	71 12/16	11.0	17.4	20.8	37.7	107	-	-	-	-	-	142	-	-	-	-	
38	-	-	-	-	-	73	-	-	-	-	-	108	107 3/16	16.1	25.5	31.3	54.2	143	142 10/16	20.2	33.9	41.7	72.8
39	38 4/16	6.0	8.7	10.8	21.5	74	73 11/16	11.3	17.9	21.4	38.7	109	-	-	-	-	-	144	-	-	-	-	
40	-	-	-	-	-	75	-	-	-	-	-	110	109 2/16	16.4	25.9	31.9	55.2						
41	40 4/16	6.2	9.2	11.4	22.3	76	75 11/16	11.6	18.4	22.0	39.6	111	-	-	-	-	-						
42	-	-	-	-	-	77	-	-	-	-	-	112	111 2/16	16.7	26.4	32.5	56.1						
43	42 3/16	6.4	9.7	12.0	23.1	78	77 10/16	11.9	18.9	22.7	40.5	113	-	-	-	-	-						
44	-	-	-	-	-	79	-	-	-	-	-	114	113 1/16	17.0	26.8	33.1	57.0						
45	44 3/16	6.7	10.2	12.6	23.9	80	79 10/16	12.2	19.4	23.3	41.4	115	-	-	-	-	-						
46	-	-	-	-	-	81	-	-	-	-	-	116	115 1/16	17.3	27.3	33.7	57.9						

Power Consumption

Tested at Full Power with PDC Series power supplies.

Standard Nominal Lengths offered provide minimal shadowing. For alternate lengths, please contact factory with specific request.

High Efficacy (HE64)

Nominal Length (in)	Back, Side, and End Feed Actual Length	Watts		Nominal Length (in)	Back, Side, and End Feed Actual Length	Watts		Nominal Length (in)	Back, Side, and End Feed Actual Length	Watts		Nominal Length (in)	Back, Side, and End Feed Actual Length	Watts	
		VHO	XHO			VHO	XHO			VHO	XHO			VHO	XHO
12	11 8/16	7.6	9.7	47	46 5/16	28.2	35.9	82	81 2/16	50.4	62.6	117	–	–	–
13	13	7.6	9.7	48	47 13/16	29.5	37.6	83	82 10/16	51.7	63.4	118	117 8/16	72.8	80.7
14	–	–	–	49	–	–	–	84	–	–	–	119	119	73.3	81.0
15	14 8/16	8.9	11.3	50	49 5/16	30.1	38.4	85	84 3/16	52.3	63.8	120	–	–	–
16	–	–	–	51	50 14/16	31.4	40.2	86	85 11/16	53.6	64.7	121	120 8/16	74.4	81.7
17	16	9.5	12.1	52	–	–	–	87	–	–	–	122	–	–	–
18	17 9/16	10.7	13.6	53	52 6/16	32.0	41.1	88	87 3/16	54.2	65.3	123	122	74.8	82.0
19	–	–	–	54	53 14/16	33.3	42.9	89	88 11/16	55.5	66.3	124	123 8/16	75.6	82.5
20	19 1/16	11.4	14.4	55	–	–	–	90	–	–	–	125	–	–	–
21	20 9/16	12.6	16.0	56	55 6/16	34.0	43.8	91	90 3/16	56.2	66.8	126	125 1/16	76.0	82.8
22	–	–	–	57	56 14/16	35.2	45.5	92	91 12/16	57.5	67.9	127	126 9/16	76.8	83.4
23	22 1/16	13.2	16.8	58	–	–	–	93	–	–	–	128	–	–	–
24	23 9/16	14.5	18.3	59	58 7/16	36.5	47.3	94	93 4/16	58.2	68.4	129	128 1/16	77.2	83.6
25	–	–	–	60	59 15/16	37.2	48.2	95	94 12/16	59.5	69.5	130	129 9/16	78.0	84.2
26	25 2/16	15.1	19.1	61	–	–	–	96	–	–	–	131	–	–	–
27	26 10/16	16.4	20.7	62	61 7/16	38.4	50.0	97	96 4/16	60.1	70.0	132	131 2/16	78.4	84.5
28	–	–	–	63	62 15/16	39.1	50.8	98	97 13/16	61.4	71.1	133	132 10/16	79.2	85.0
29	28 2/16	17.0	21.4	64	–	–	–	99	–	–	–	134	–	–	–
30	29 10/16	18.2	23.0	65	64 8/16	40.4	52.5	100	99 5/16	62.0	71.7	135	134 2/16	79.6	85.4
31	–	–	–	66	66	41.0	53.4	101	100 13/16	63.2	72.9	136	135 10/16	80.3	86.2
32	31 3/16	18.9	23.8	67	–	–	–	102	–	–	–	137	–	–	–
33	32 11/16	20.1	25.3	68	67 8/16	42.3	55.1	103	102 5/16	63.8	73.5	138	137 2/16	80.6	86.6
34	–	–	–	69	–	–	–	104	103 13/16	65.0	74.7	139	138 11/16	81.3	87.5
35	34 3/16	20.7	26.1	70	69	42.9	55.9	105	–	–	–	140	–	–	–
36	35 11/16	22.0	27.6	71	70 8/16	44.2	57.6	106	105 6/16	65.6	75.3	141	140 3/16	81.7	87.9
37	–	–	–	72	–	–	–	107	106 14/16	66.8	76.5	142	141 11/16	82.4	88.7
38	37 3/16	22.6	28.4	73	72 1/16	44.9	58.5	108	–	–	–	143	–	–	–
39	38 12/16	23.9	30.1	74	73 9/16	46.1	59.7	109	108 6/16	67.4	77.1	144	143 3/16	82.7	89.1
40	–	–	–	75	–	–	–	110	109 14/16	68.5	78.0				
41	40 4/16	24.5	30.9	76	75 1/16	46.7	60.1	111	–	–	–				
42	41 12/16	25.7	32.6	77	76 9/16	48.0	60.9	112	111 7/16	69.6	78.7				
43	–	–	–	78	–	–	–	113	112 15/16	70.1	79.0				
44	43 4/16	26.4	33.4	79	78 2/16	48.6	61.3	114	–	–	–				
45	44 13/16	27.6	35.1	80	79 10/16	49.8	62.2	115	114 7/16	71.2	79.7				
46	–	–	–	81	–	–	–	116	115 15/16	71.7	80.0				

Voltage Drop Calculator

The below chart assumes nominal voltage of 24 Volts and a Voltage Drop Allowance of 3% through the wire

Wattage [W]	Wire Length From Power Supply to Start of Run [ft]						
	12 AWG	14 AWG	16 AWG	18 AWG	20 AWG	22 AWG	24 AWG
5	1088.2	684.4	430.3	270.6	170.2	107.1	67.3
10	544.1	342.2	215.1	135.3	85.1	53.5	33.7
15	362.7	228.1	143.4	90.2	56.7	35.7	22.4
20	272.0	171.1	107.6	67.7	42.6	26.8	16.8
25	217.6	136.9	86.1	54.1	34.0	21.4	13.5
30	181.4	114.1	71.7	45.1	28.4	17.8	11.2
35	155.5	97.8	61.5	38.7	24.3	15.3	9.6
40	136.0	85.5	53.8	33.8	21.3	13.4	8.4
45	120.9	76.0	47.8	30.1	18.9	11.9	7.5
50	108.8	68.4	43.0	27.1	17.0	10.7	6.7
55	98.9	62.2	39.1	24.6	15.5	9.7	6.1
60	90.7	57.0	35.9	22.6	14.2	8.9	5.6
65	83.7	52.6	33.1	20.8	13.1	8.2	5.2
70	77.7	48.9	30.7	19.3	12.2	7.6	4.8
75	72.5	45.6	28.7	18.0	11.3	7.1	4.5
80	68.0	42.8	26.9	16.9	10.6	6.7	4.2
85	64.0	40.3	25.3	15.9	10.0	6.3	4.0
90	60.5	38.0	23.9	15.0	9.5	5.9	3.7
96	56.7	35.6	22.4	14.1	8.9	5.6	3.5

Power Supplies

See Power Supply instructions and spec sheet for wiring information. For a complete list of compatible dimmers, see Compatible Dimming Chart on the Resources page.

Universal Power Supply 1% 120VAC - 277VAC

MODEL	POWER	OUTPUT
PDCU-D - IP20 Dry Series	30 - 30 W 60 - 60 W 96 - 96 W 3X96 - 3X96 W	24 - 24 VDC
PDCU-W - IP66 Wet Series	96 - 96 W 3X96 - 3X96 W	

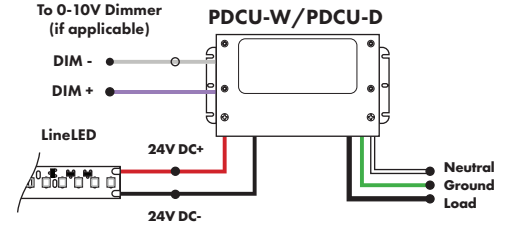

0-10V dims down to 1%, MLV/ELV/TRIAC dims down to 1%.
For a complete list of compatible dimmers, see [Compatible Dimming Chart](#) on the Resources page.

MODELS	PDCU-W 96W	PDCU-W 3X96W	PDCU-D 30W	PDCU-D 60W	PDCU-D 96W	PDCU-D 3X96W
Length	8.66"	11.85"	6.10"	7.93"	8.25"	9.57"
Width	3.73"	4.32"	3.35"	3.35"	4.10"	5.94"
Depth	1.61"	1.81"	1.33"	1.32"	1.56"	1.13"

0-10V Dimming Power Supplies 0.1% 120VAC - 277VAC

MODEL	POWER	OUTPUT	DIMMING
PS010V - 0-10V Power Supply dims down to 0.1%	96 - 96 Watt 3X96 - 3 X 96 Watt	24 - 24 VDC	LIN - Linear LOG - Logarithmic

MODELS	96W	3X96
Length	14.40"	15.75"
Width	5.20"	6.62"
Depth	2.60"	4.95"

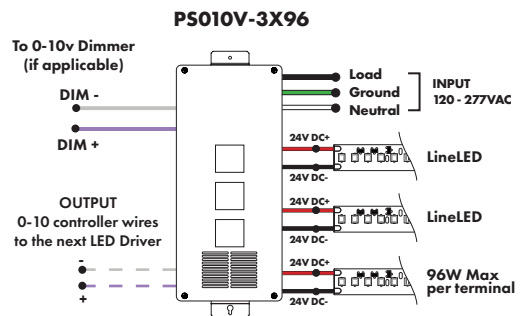
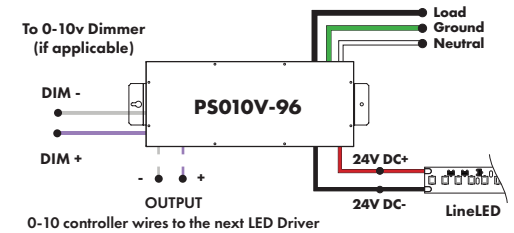

Triac, MLV, & ELV Compatible Dimmers

MODEL	POWER	OUTPUT
PDC - (IP20) Power Supply	96 - 96 Watts	24 - 24 VDC

MODELS	96W
Length	8.25"
Width	4.10"
Depth	1.56"

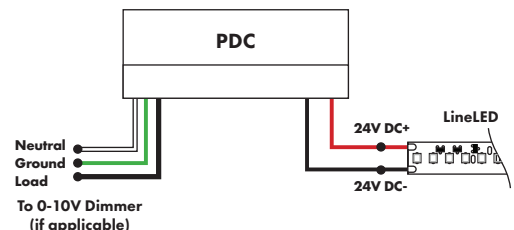

Power Supplies

See Power Supply instructions and spec sheet for wiring information. For a complete list of compatible dimmers, see Compatible Dimming Chart on the Resources page.

DMX Dimming Power Supplies 120VAC - 277VAC

MODEL	POWER	OUTPUT
PSDMX - DMX Power Supply dims down to 0%	96 - 96 Watt 3X96 - 3 X 96 Watt	24 - 24 VDC

Features eldoLED's LINEARdrive configurable dimmable drivers

MODELS	96W	3X96
Length	14.40"	15.75"
Width	5.20"	6.62"
Depth	2.60"	4.95"

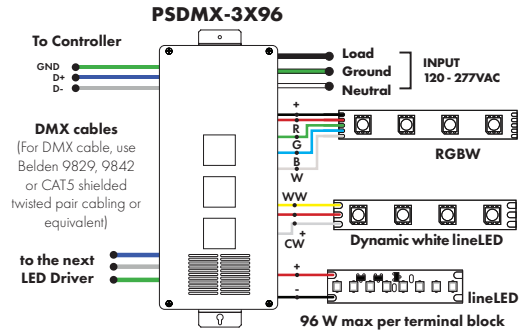
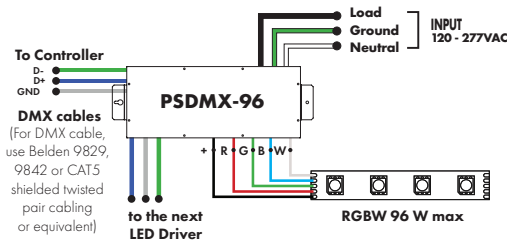

DALI 0% Dimming Power Supplies 120VAC - 277VAC

MODEL	POWER	OUTPUT
PSDALI - DALI Power Supply dims down to 0%	96 - 96 Watt 3X96 - 3 X 96 Watt	24 - 24 VDC

Features eldoLED's LINEARdrive configurable dimmable drivers

Model	96W	3X96
Length	14.40"	15.75"
Width	5.20"	6.62"
Depth	2.60"	4.95"

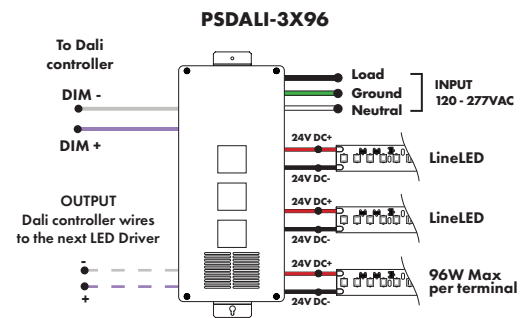
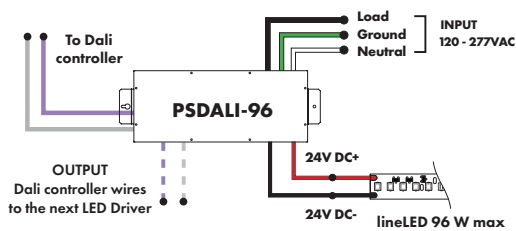

Enlighted Enabled Dimming Power Supplies 120VAC - 277VAC

MODEL	POWER	OUTPUT	DIMMING	LOCATION
PSV - PSV Series	96 - 96 Watt	24 - 24 VDC	ENL - Enlighted Dimming dims down to 0%	D - Damp

Model	96W
Length	14.40"
Width	5.20"
Depth	2.60"

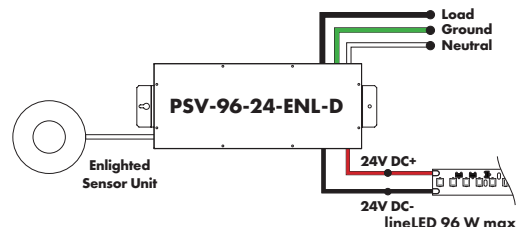

Power Supplies

See Power Supply instructions and spec sheet for wiring information. For a complete list of compatible dimmers, see Compatible Dimming Chart on the Resources page.

Non-Dimming Power Supply 120VAC - 277VAC

MODEL	POWER	OUTPUT	DIMMING	LOCATION
PSV - PSV Series	96 - 96 Watt	24 - 24 VDC	ND - Non Dimming	D - Damp

MODELS	96W
Length	14.40"
Width	5.20"
Depth	2.60"

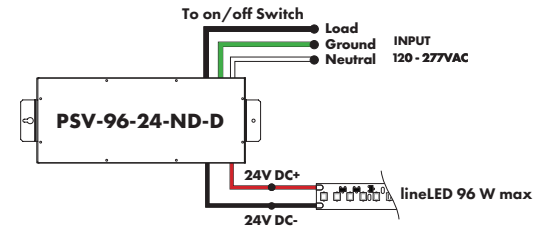

Luminii is a Lutron OEM Advantage Partner

Lutron Power Supplies 1%

MODEL
L3DA4U1UKL-CV240

HiLume™ 1% EcoSystem Voltage LED driver
40W max

MODELS	L3DA4U1UKL-CV240
Length	4.98"
Width	4.00"
Depth	2.62"

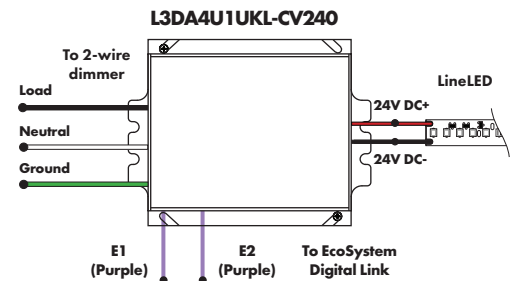

Luminii is a Lutron OEM Advantage Partner

Lutron Power Supplies 0.1%

MODEL
L3D0-96W24V-U

HiLume™ 0.1% EcoSystem Voltage LED Driver with Soft-On, Fade-to-Black™
96W max

MODELS	L3D0
Length	10.50"
Width	5.50"
Depth	2.00"

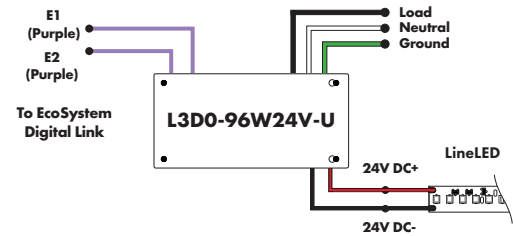

In-Ground Power Supplies

MODEL	POWER	OUTPUT	INPUT
IG - In ground CVE Series CVE - ELV Dimming DALI - eldoLED Dali dimming Both dims down to 0%	96X2 - 2 X 96 Watt	24 - 24 VDC	Blank - 120 V 277 - 240/277 V

MODELS	Dual Circuit
Length	8.40"
Width	8.30"
Depth	8.10"

