



Features

The KS Channel linear aluminum extrusion has been designed to fit many LED lighting needs. Multiple mounting and lens options allow for great flexibility and adaptability for any application. Extrusion and diffuser lenses are also field cuttable. Substantial aluminum mass in profile provides excellent heat sink for high power LEDs. Channels come with specified Mounting Clips and End Caps.

Finish

Silver anodized, White, Black, Bronze

Mounting

Multiple mounting clip

Diffuser Lens

Polycarbonate, snap-in-place, UV resistant



Product Dimensions

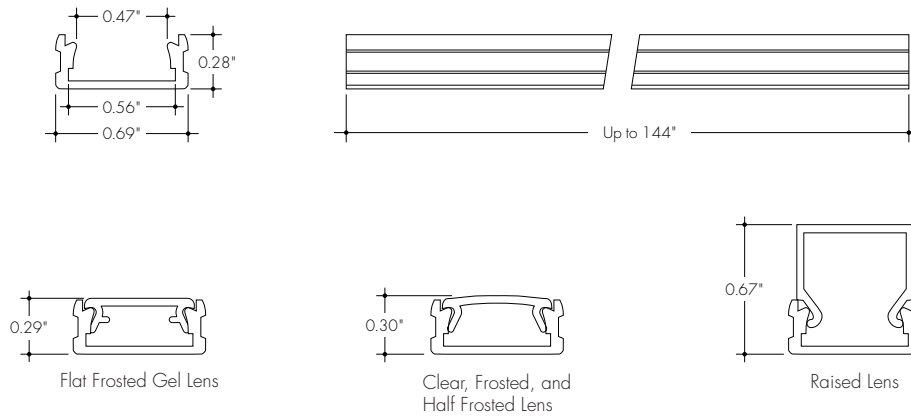

INCLUDED MOUNTING ACCESSORIES

EXTRUSION LENGTH	MOUNTING CLIPS (ALL TYPES)	ENDCAP PAIR
48"	3	1
72"	3	1
96"	4	1
144"	5	1

Each pair of endcaps includes 1x H3 (no wire feed hole) and 1x H4 (with hole) where applicable. Additional endcaps and mounting clips are available for purchase.

Ordering code

MODEL	LENGTH	LENS	MOUNTING ²	FINISH ⁴
KSC - KS Channel ¹	48 - 48" 72 - 72" 96 - 96" ³ 144 - 144" ³	C - Clear F - Frosted HF - Half Frosted M - Medium R - Raised FF - Flat Frosted Gel	FC - Fixed Clip FC45 - Fixed, Clip 45° A - Adjustable EFC - Tamper Resistant Fixed Clip	SA - Silver Anodized WH - White BK - Black BZ - Bronze

1 - End Caps are included with channel, one of H3 (no hole) and one of H4 (with hole). Order additional End Caps as necessary.
 2 - Mounting Clips are included with channel. Refer to chart above for provided mounting clip quantities. Order additional Mounting Clips as necessary.
 3 - For Channels and lenses over 90", incremental shipping charges will apply.
 4 - Non SA finishes may have extended lead times. Custom RALs are available, please consult Inside Sales with specific request.

All Channels come with a specified set of Mounting Clips and End Caps, see Ordering Code for details. Order additional Mounting Clips and End Caps as necessary.

Mounting Clips

MB-KMSC-XX
Fixed mounting clip
-FC

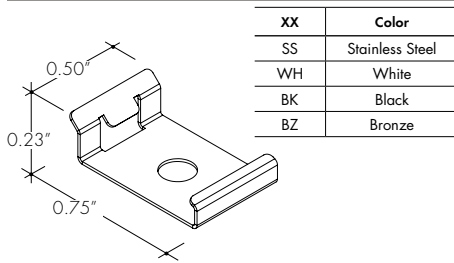

MB-KMSC-45-XX
Fixed mounting clip 45°
-FC45

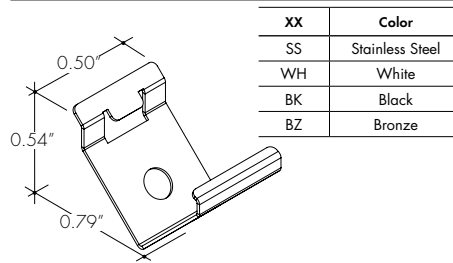

MB-KMSC-A-XX
Adjustable mounting clip
-A

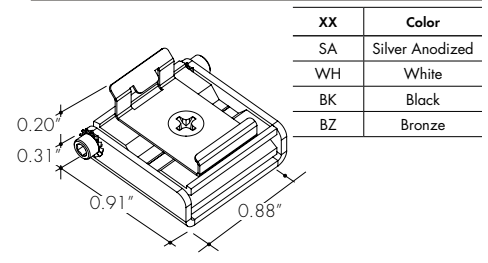

MB-KMSC-EFC-SS
Tamper Resistant Fixed Clip
-EFC

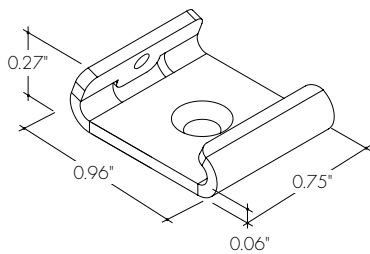

End Caps

EC-KSC-F-H4-XX
End Cap with Powerfeed Opening

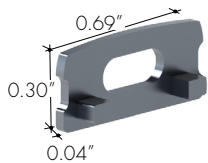

EC-KSC-F-H3-XX
End Cap

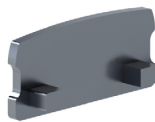

EC-KSC-G-H4-XX
End Cap with Powerfeed Opening

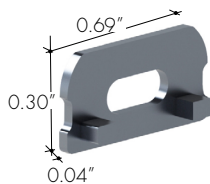

EC-KSC-G-H3-XX
End Cap

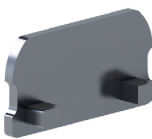

EC-KSC-R-H4-XX
End Cap with Powerfeed Opening

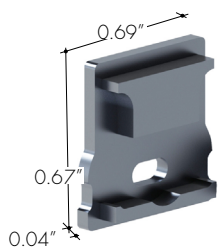

EC-KSC-R-H3-XX
End Cap

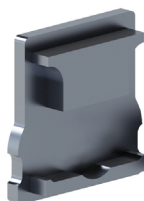

XX	Color
SA	Silver Anodized
WH	White
BK	Black
BZ	Bronze

