

DOMINO 2 SURFACE

12° NARROW BEAM



TECHNICAL DESCRIPTION

Domino 2 Surface is a Constant Current multi source LED spotlight that is machined from aerospace grade aluminium 6063-T6 and comes as standard in white, black and brushed aluminium. It has five site-changeable beam distributions including elliptical beams. The narrow beam in our 4.48W 360lm module has a peak intensity of 3132cd.

MECHANICAL & ELECTRICAL

CATEGORY IP20	WATTAGE 4.48W
MATERIAL Machined AL 6063-T6	FORWARD VOLTAGE 6.4V
PAN N/A	DRIVE CURRENT 700mA
TILT N/A	SUPPLY TYPE Constant Current
LOCKABLE N/A	DRIVER LOCATION Remote
WEIGHT 101g 0.22lb	DIMMING DALI 0-10V 1-10V Casambi

MOUNTING





MOUNTING Surface mounting plate	CUTOUT ø17mm (0.67")
CEILING THICKNESS N/A	MIN CEILING VOID N/A

FINISHES

FINISHES Brushed Aluminium | Black RAL9005 | White RAL9010

*Premium & custom finishes are built & finished to order. These are subject to an extended lead time & MOQ.

OPTICAL & STANDARDS

NOMINAL LUMENS 360lm	BEAM ANGLE 12°
DELIVERED LUMENS 328lm	CRI 95 TYP
COLOUR TEMPERATURE 2700K 3000K	TM-30 RF: 93 RG: 99
ACCESSORY HOLDER N/A	WARRANTY 5 Years
ACCESSORIES N/A	LIFETIME L90B10 100,000hrs
TM65 8.74kgCO2e	STANDARDS
TM66 2.4	   

Photometry shown is for 3000K module. Please enquire for other CCT photometry.

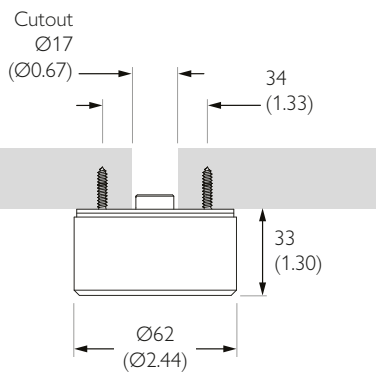

mm (inches)

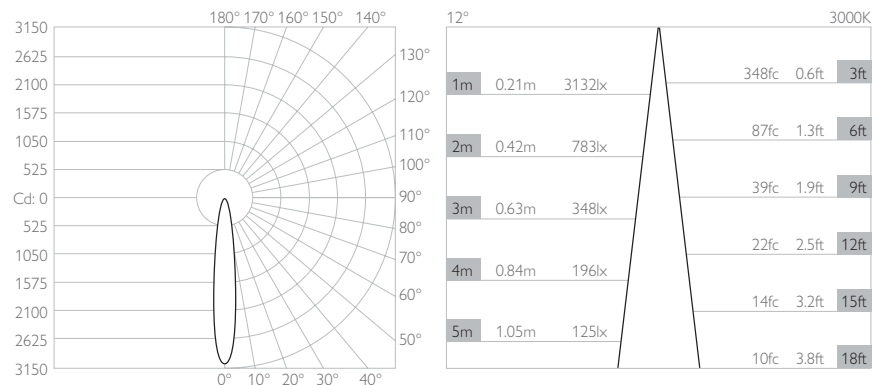
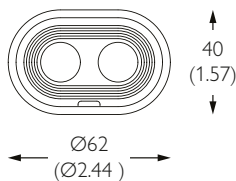

LUMINAIRE FINISH

White 9010	Black 9005	Brushed Aluminium	Rubbed Bronze*	Polished Brass*	Brushed Brass*
TZ-652-WH-XX9512	TZ-652-BK-XX9512	TZ-652-AL-XX9512			

*All premium & custom finishes are built & finished to order. These are subject to an extended lead time & MOQ

For 3000K Substitute XX with 30

For 2700K Substitute XX with 27

DOMINO 2 SURFACE

30° FLOOD BEAM



TECHNICAL DESCRIPTION

Domino 2 Surface is a Constant Current multi source LED spotlight that is machined from aerospace grade aluminium 6063-T6 and comes as standard in white, black and brushed aluminium. It has five site-changeable beam distributions including elliptical beams. The flood beam in our 4.48W 360lm module has a peak intensity of 940cd.

MECHANICAL & ELECTRICAL

CATEGORY IP20	WATTAGE 4.48W
MATERIAL Machined AL 6063-T6	FORWARD VOLTAGE 6.4V
PAN N/A	DRIVE CURRENT 700mA
TILT N/A	SUPPLY TYPE Constant Current
LOCKABLE N/A	DRIVER LOCATION Remote
WEIGHT 101g 0.22lb	DIMMING DALI 0-10V 1-10V Casambi

MOUNTING





MOUNTING Surface mounting plate	CUTOUT ø17mm (0.67")
CEILING THICKNESS N/A	MIN CEILING VOID N/A

FINISHES

FINISHES Brushed Aluminium | Black RAL9005 | White RAL9010

*Premium & custom finishes are built & finished to order. These are subject to an extended lead time & MOQ.

OPTICAL & STANDARDS

NOMINAL LUMENS 360lm	BEAM ANGLE 30°
DELIVERED LUMENS 300lm	CRI 95 TYP
COLOUR TEMPERATURE 2700K 3000K	TM-30 RF: 93 RG: 99
ACCESSORY HOLDER N/A	WARRANTY 5 Years
ACCESSORIES N/A	LIFETIME L90B10 100,000hrs
TM65 8.74kgCO2e	STANDARDS
TM66 2.4	   

Photometry shown is for 3000K module. Please enquire for other CCT photometry.

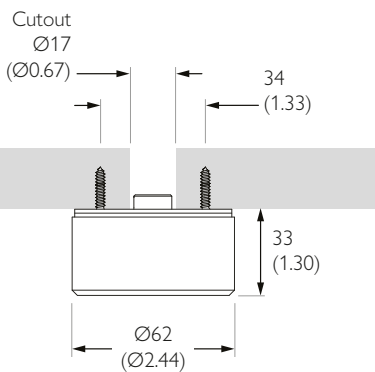

mm (inches)

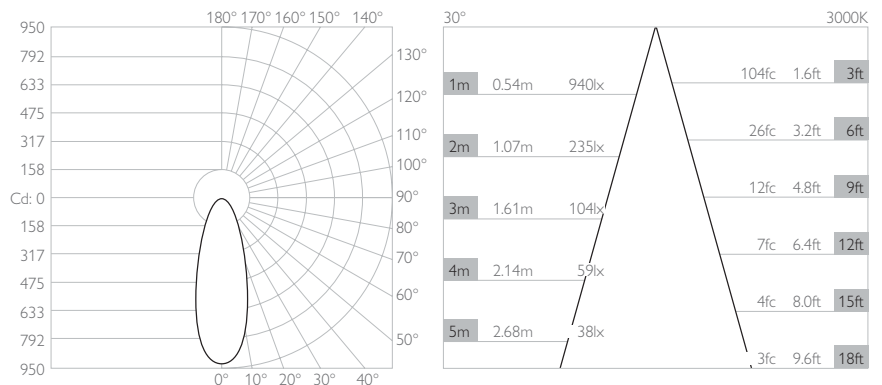
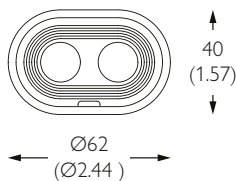

LUMINAIRE FINISH

White 9010	Black 9005	Brushed Aluminium	Rubbed Bronze*	Polished Brass*	Brushed Brass*
TZ-652-WH-XX9530	TZ-652-BK-XX9530	TZ-652-AL-XX9530			

*All premium & custom finishes are built & finished to order. These are subject to an extended lead time & MOQ

For 3000K Substitute XX with 30

For 2700K Substitute XX with 27

DOMINO 2 SURFACE

60° WIDE FLOOD BEAM



TECHNICAL DESCRIPTION

Domino 2 Surface is a Constant Current multi source LED spotlight that is machined from aerospace grade aluminium 6063-T6 and comes as standard in white, black and brushed aluminium. It has five site-changeable beam distributions including elliptical beams. The wide flood beam in our 4.48W 360lm module has a peak intensity of 326cd.

MECHANICAL & ELECTRICAL

CATEGORY IP20	WATTAGE 4.48W
MATERIAL Machined AL 6063-T6	FORWARD VOLTAGE 6.4V
PAN N/A	DRIVE CURRENT 700mA
TILT N/A	SUPPLY TYPE Constant Current
LOCKABLE N/A	DRIVER LOCATION Remote
WEIGHT 101g 0.22lb	DIMMING DALI 0-10V 1-10V Casambi

MOUNTING





MOUNTING Surface mounting plate	CUTOUT ø17mm (0.67")
CEILING THICKNESS N/A	MIN CEILING VOID N/A

FINISHES

FINISHES Brushed Aluminium | Black RAL9005 | White RAL9010

*Premium & custom finishes are built & finished to order. These are subject to an extended lead time & MOQ.

OPTICAL & STANDARDS

NOMINAL LUMENS 360lm	BEAM ANGLE 60°
DELIVERED LUMENS 326lm	CRI 95 TYP
COLOUR TEMPERATURE 2700K 3000K	TM-30 RF: 93 RG: 99
ACCESSORY HOLDER N/A	WARRANTY 5 Years
ACCESSORIES N/A	LIFETIME L90B10 100,000hrs
TM65 8.74kgCO2e	STANDARDS
TM66 2.4	   

Photometry shown is for 3000K module. Please enquire for other CCT photometry.

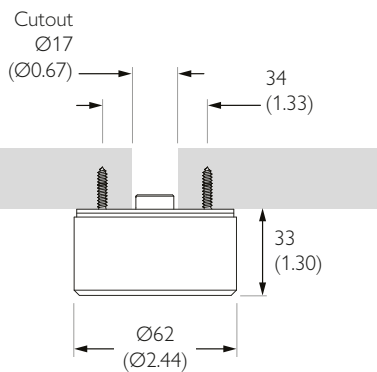

mm (inches)

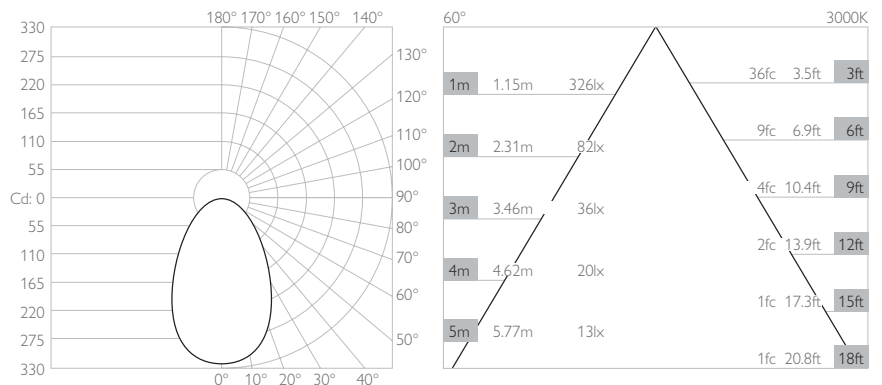
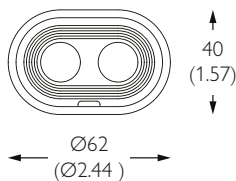

LUMINAIRE FINISH

White 9010	Black 9005	Brushed Aluminium	Rubbed Bronze*	Polished Brass*	Brushed Brass*
TZ-652-WH-XX9560	TZ-652-BK-XX9560	TZ-652-AL-XX9560			

*All premium & custom finishes are built & finished to order. These are subject to an extended lead time & MOQ

For 3000K Substitute XX with 30

For 2700K Substitute XX with 27

DOMINO 2 SURFACE

12X35° ELLIPSE BEAM



TECHNICAL DESCRIPTION

Domino 2 Surface is a Constant Current multi source LED spotlight that is machined from aerospace grade aluminium 6063-T6 and comes as standard in white, black and brushed aluminium. It has five site-changeable beam distributions including elliptical beams. The ellipse beam in our 4.48W 360lm module has a peak intensity of 1944cd.

MECHANICAL & ELECTRICAL

CATEGORY IP20	WATTAGE 4.48W
MATERIAL Machined AL 6063-T6	FORWARD VOLTAGE 6.4V
PAN N/A	DRIVE CURRENT 700mA
TILT N/A	SUPPLY TYPE Constant Current
LOCKABLE N/A	DRIVER LOCATION Remote
WEIGHT 101g 0.22lb	DIMMING DALI 0-10V 1-10V Casambi

MOUNTING





MOUNTING Surface mounting plate	CUTOUT ø17mm (0.67")
CEILING THICKNESS N/A	MIN CEILING VOID N/A

FINISHES

FINISHES Brushed Aluminium | Black RAL9005 | White RAL9010

*Premium & custom finishes are built & finished to order. These are subject to an extended lead time & MOQ.

OPTICAL & STANDARDS

NOMINAL LUMENS 360lm	BEAM ANGLE 12x35°
DELIVERED LUMENS 328lm	CRI 95 TYP
COLOUR TEMPERATURE 2700K 3000K	TM-30 RF: 93 RG: 99
ACCESSORY HOLDER N/A	WARRANTY 5 Years
ACCESSORIES N/A	LIFETIME L90B10 100,000hrs
TM65 8.74kgCO2e	STANDARDS
TM66 2.4	   

Photometry shown is for 3000K module. Please enquire for other CCT photometry.

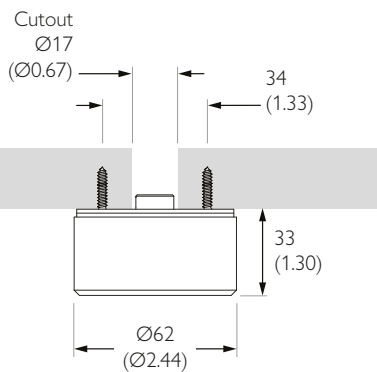

mm (inches)

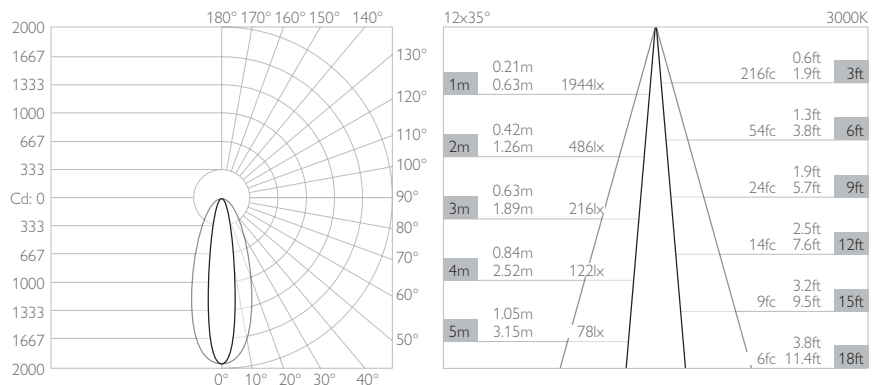
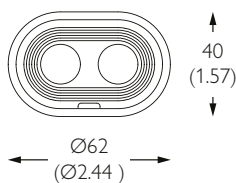

LUMINAIRE FINISH

White 9010	Black 9005	Brushed Aluminium	Rubbed Bronze*	Polished Brass*	Brushed Brass*
TZ-652-WH-XX95E1	TZ-652-BK-XX95E1	TZ-652-AL-XX95E1			

*All premium & custom finishes are built & finished to order. These are subject to an extended lead time & MOQ

For 3000K Substitute XX with 30

For 2700K Substitute XX with 27

DOMINO 2 SURFACE

35X12° VERTICAL ELLIPSE BEAM



TECHNICAL DESCRIPTION

Domino 2 Surface is a Constant Current multi source LED spotlight that is machined from aerospace grade aluminium 6063-T6 and comes as standard in white, black and brushed aluminium. It has five site-changeable beam distributions including elliptical beams. The vertical ellipse beam in our 4.48W 360lm module has a peak intensity of 1944cd.

MECHANICAL & ELECTRICAL

CATEGORY IP20	WATTAGE 4.48W
MATERIAL Machined AL 6063-T6	FORWARD VOLTAGE 6.4V
PAN N/A	DRIVE CURRENT 700mA
TILT N/A	SUPPLY TYPE Constant Current
LOCKABLE N/A	DRIVER LOCATION Remote
WEIGHT 101g 0.22lb	DIMMING DALI 0-10V 1-10V Casambi

MOUNTING





MOUNTING Surface mounting plate	CUTOUT ø17mm (0.67")
CEILING THICKNESS N/A	MIN CEILING VOID N/A

FINISHES

FINISHES Brushed Aluminium | Black RAL9005 | White RAL9010

*Premium & custom finishes are built & finished to order. These are subject to an extended lead time & MOQ.

OPTICAL & STANDARDS

NOMINAL LUMENS 360lm	BEAM ANGLE 35x12°
DELIVERED LUMENS 328lm	CRI 95 TYP
COLOUR TEMPERATURE 2700K 3000K	TM-30 RF: 93 RG: 99
ACCESSORY HOLDER N/A	WARRANTY 5 Years
ACCESSORIES N/A	LIFETIME L90B10 100,000hrs
TM65 8.74kgCO2e	STANDARDS
TM66 2.4	   

Photometry shown is for 3000K module. Please enquire for other CCT photometry.

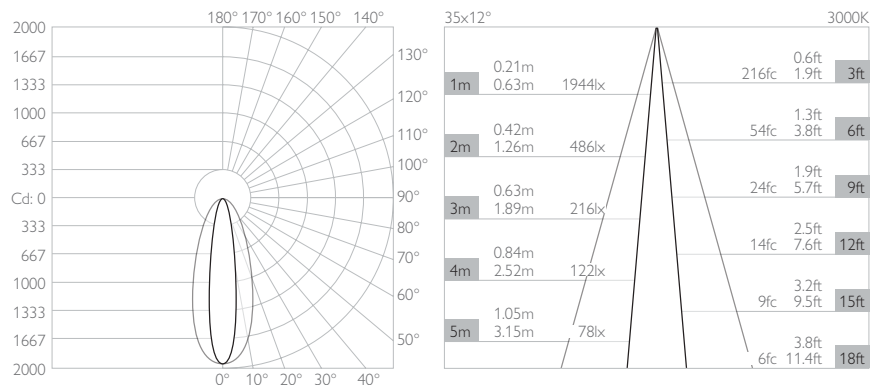
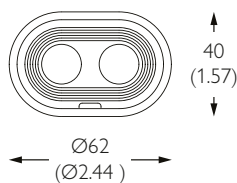
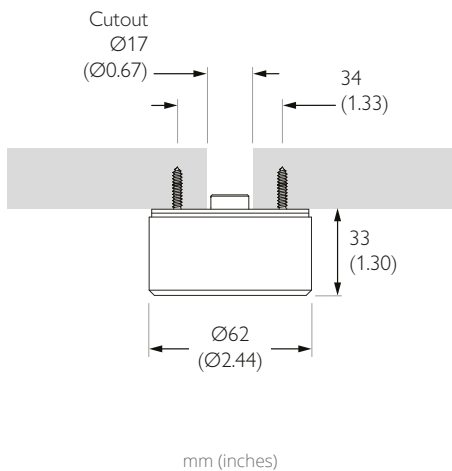

LUMINAIRE FINISH

White 9010	Black 9005	Brushed Aluminium	Rubbed Bronze*	Polished Brass*	Brushed Brass*
TZ-652-WH-XX95E2	TZ-652-BK-XX95E2	TZ-652-AL-XX95E2			

*All premium & custom finishes are built & finished to order. These are subject to an extended lead time & MOQ

For 3000K Substitute XX with 30

For 2700K Substitute XX with 27

DOMINO 2

DRIVER COMPATIBILITY

20W | DIMMING: DALI OR 0-10V

NO. OF LIGHTS PER DRIVER 1 to 4 in series

MIN DIM LEVEL 0.1%

VOLTAGE REGION 230V

FOR NORTH AMERICA No

WATTAGE 20W

SUPPLY TYPE Constant Current

DRIVER LOCATION Remote

MANUFACTURER Eldoled



DALI CODE PSCC-20-700-D-EL

0-10V CODE PSCC-20-700-A-EL

LENGTH 160mm (6.30") WIDTH 41mm (1.63") HEIGHT 30mm (1.18")



30W | DIMMING: DALI OR 0-10V

NO. OF LIGHTS PER DRIVER 1 to 6 in series

MIN DIM LEVEL 0.1%

VOLTAGE REGION 120V

FOR NORTH AMERICA Yes

WATTAGE 30W

SUPPLY TYPE Constant Current

DRIVER LOCATION Remote

MANUFACTURER Eldoled



DALI CODE USCC-30-700-D-EL-ENC

0-10V CODE USCC-30-700-A-EL-ENC

LENGTH 348mm (13.7") WIDTH 65mm (2.6") HEIGHT 47mm (1.9")



12W | DIMMING: PHASE

NO. OF LIGHTS PER DRIVER 1 to 2 in series

MIN DIM LEVEL 1%

VOLTAGE REGION 120V

FOR NORTH AMERICA Yes

WATTAGE 12W

SUPPLY TYPE Constant Current

DRIVER LOCATION Remote

MANUFACTURER Hatch



PHASE CODE USCC-12-700-P-HT-ENC

LENGTH 247mm (9.7") WIDTH 65mm (2.6") HEIGHT 47mm (1.9")

