

# DOMINO 1 SURFACE

## 12° NARROW BEAM



### TECHNICAL DESCRIPTION

Domino 1 Surface is a Constant Current multi source LED spotlight that is machined from aerospace grade aluminium 6063-T6 and comes as standard in white, black and brushed aluminium. It has five site-changeable beam distributions including elliptical beams. The narrow beam in our 2.24W 180lm module has a peak intensity of 1566cd.

### MECHANICAL & ELECTRICAL

<b>CATEGORY</b> IP20	<b>WATTAGE</b> 2.24W
<b>MATERIAL</b> Machined AL 6063-T6	<b>FORWARD VOLTAGE</b> 3.2V
<b>PAN</b> N/A	<b>DRIVE CURRENT</b> 700mA
<b>TILT</b> N/A	<b>SUPPLY TYPE</b> Constant Current
<b>LOCKABLE</b> N/A	<b>DRIVER LOCATION</b> Remote
<b>WEIGHT</b> 64g   0.14lb	<b>DIMMING</b> DALI   0-10V   1-10V   Casambi

### MOUNTING





<b>MOUNTING</b> Surface mounting plate	<b>CUTOUT</b> ø17mm (0.67")
<b>CEILING THICKNESS</b> N/A	<b>MIN CEILING VOID</b> N/A

### FINISHES

**FINISHES** Brushed Aluminium | Black RAL9005 | White RAL9010

\*Premium & custom finishes are built & finished to order. These are subject to an extended lead time & MOQ.

### OPTICAL & STANDARDS

<b>NOMINAL LUMENS</b> 180lm	<b>BEAM ANGLE</b> 12°
<b>DELIVERED LUMENS</b> 164lm	<b>CRI</b> 95 TYP
<b>COLOUR TEMPERATURE</b> 2700K   3000K	<b>TM-30</b> RF: 93 RG: 99
<b>ACCESSORY HOLDER</b> N/A	<b>WARRANTY</b> 5 Years
<b>ACCESSORIES</b> N/A	<b>LIFETIME</b> L90B10 100,000hrs
<b>TM65</b> 7.66kgCO2e	<b>STANDARDS</b>
<b>TM66</b> 2.4	   

Photometry shown is for 3000K module. Please enquire for other CCT photometry.

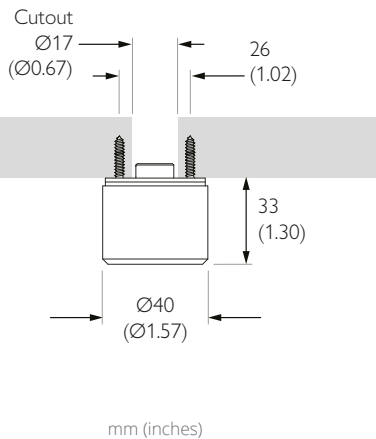

mm (inches)

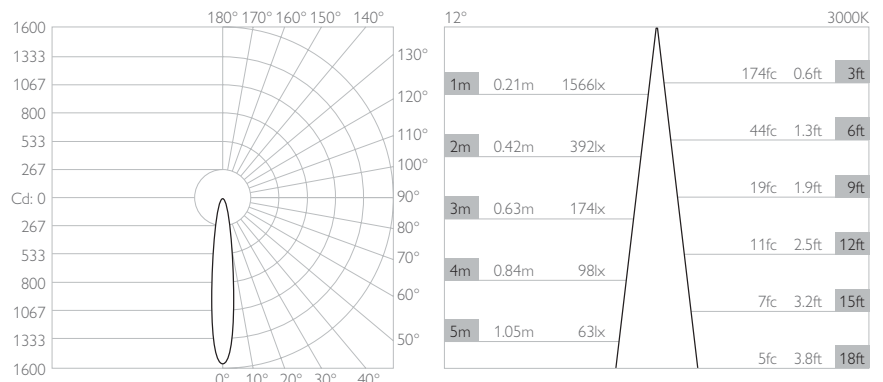
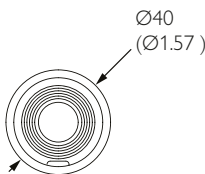

### LUMINAIRE FINISH

White 9010	Black 9005	Brushed Aluminium	Rubbed Bronze*	Polished Brass*	Brushed Brass*
TZ-651-WH-XX9512	TZ-651-BK-XX9512	TZ-651-AL-XX9512			

\*All premium & custom finishes are built & finished to order. These are subject to an extended lead time & MOQ

For 3000K Substitute XX with 30

For 2700K Substitute XX with 27

# DOMINO 1 SURFACE

## 30° FLOOD BEAM



### TECHNICAL DESCRIPTION

Domino 1 Surface is a Constant Current multi source LED spotlight that is machined from aerospace grade aluminium 6063-T6 and comes as standard in white, black and brushed aluminium. It has five site-changeable beam distributions including elliptical beams. The flood beam in our 2.24W 180lm module has a peak intensity of 470cd.

### MECHANICAL & ELECTRICAL

<b>CATEGORY</b> IP20	<b>WATTAGE</b> 2.24W
<b>MATERIAL</b> Machined AL 6063-T6	<b>FORWARD VOLTAGE</b> 3.2V
<b>PAN</b> N/A	<b>DRIVE CURRENT</b> 700mA
<b>TILT</b> N/A	<b>SUPPLY TYPE</b> Constant Current
<b>LOCKABLE</b> N/A	<b>DRIVER LOCATION</b> Remote
<b>WEIGHT</b> 64g   0.14lb	<b>DIMMING</b> DALI   0-10V   1-10V   Casambi

### MOUNTING





<b>MOUNTING</b> Surface mounting plate	<b>CUTOUT</b> ø17mm (0.67")
<b>CEILING THICKNESS</b> N/A	<b>MIN CEILING VOID</b> N/A

### FINISHES

**FINISHES** Brushed Aluminium | Black RAL9005 | White RAL9010

\*Premium & custom finishes are built & finished to order. These are subject to an extended lead time & MOQ.

### OPTICAL & STANDARDS

<b>NOMINAL LUMENS</b> 180lm	<b>BEAM ANGLE</b> 30°
<b>DELIVERED LUMENS</b> 150lm	<b>CRI</b> 95 TYP
<b>COLOUR TEMPERATURE</b> 2700K   3000K	<b>TM-30</b> RF: 93 RG: 99
<b>ACCESSORY HOLDER</b> N/A	<b>WARRANTY</b> 5 Years
<b>ACCESSORIES</b> N/A	<b>LIFETIME</b> L90B10 100,000hrs
<b>TM65</b> 7.66kgCO2e	<b>STANDARDS</b>
<b>TM66</b> 2.4	   

Photometry shown is for 3000K module. Please enquire for other CCT photometry.

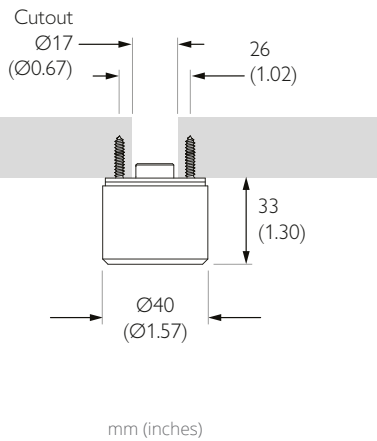

mm (inches)

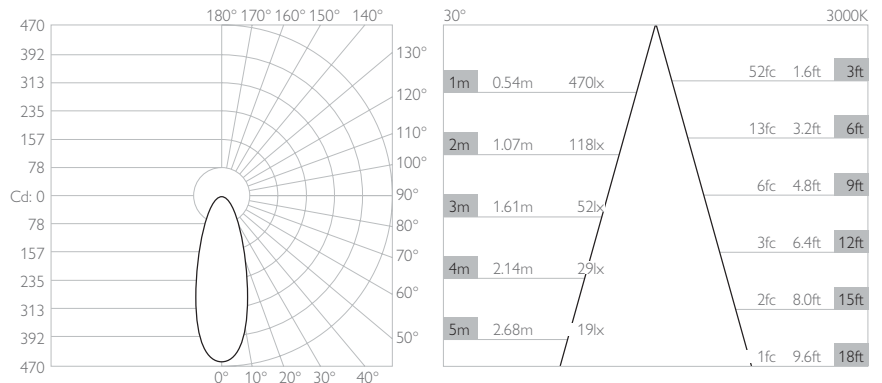
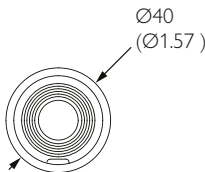

### LUMINAIRE FINISH

White 9010	Black 9005	Brushed Aluminium	Rubbed Bronze*	Polished Brass*	Brushed Brass*
TZ-651-WH-XX9530	TZ-651-BK-XX9530	TZ-651-AL-XX9530			

\*All premium & custom finishes are built & finished to order. These are subject to an extended lead time & MOQ

For 3000K Substitute XX with 30

For 2700K Substitute XX with 27

# DOMINO 1 SURFACE

## 60° WIDE FLOOD BEAM



### TECHNICAL DESCRIPTION

Domino 1 Surface is a Constant Current multi source LED spotlight that is machined from aerospace grade aluminium 6063-T6 and comes as standard in white, black and brushed aluminium. It has five site-changeable beam distributions including elliptical beams. The wide flood beam in our 2.24W 180lm module has a peak intensity of 163cd.

### MECHANICAL & ELECTRICAL

<b>CATEGORY</b> IP20	<b>WATTAGE</b> 2.24W
<b>MATERIAL</b> Machined AL 6063-T6	<b>FORWARD VOLTAGE</b> 3.2V
<b>PAN</b> N/A	<b>DRIVE CURRENT</b> 700mA
<b>TILT</b> N/A	<b>SUPPLY TYPE</b> Constant Current
<b>LOCKABLE</b> N/A	<b>DRIVER LOCATION</b> Remote
<b>WEIGHT</b> 64g   0.14lb	<b>DIMMING</b> DALI   0-10V   1-10V   Casambi

### MOUNTING





<b>MOUNTING</b> Surface mounting plate	<b>CUTOUT</b> ø17mm (0.67")
<b>CEILING THICKNESS</b> N/A	<b>MIN CEILING VOID</b> N/A

### FINISHES

**FINISHES** Brushed Aluminium | Black RAL9005 | White RAL9010

\*Premium & custom finishes are built & finished to order. These are subject to an extended lead time & MOQ.

### OPTICAL & STANDARDS

<b>NOMINAL LUMENS</b> 180lm	<b>BEAM ANGLE</b> 60°
<b>DELIVERED LUMENS</b> 163lm	<b>CRI</b> 95 TYP
<b>COLOUR TEMPERATURE</b> 2700K   3000K	<b>TM-30</b> RF: 93 RG: 99
<b>ACCESSORY HOLDER</b> N/A	<b>WARRANTY</b> 5 Years
<b>ACCESSORIES</b> N/A	<b>LIFETIME</b> L90B10 100,000hrs
<b>TM65</b> 7.66kgCO2e	<b>STANDARDS</b>
<b>TM66</b> 2.4	   

Photometry shown is for 3000K module. Please enquire for other CCT photometry.

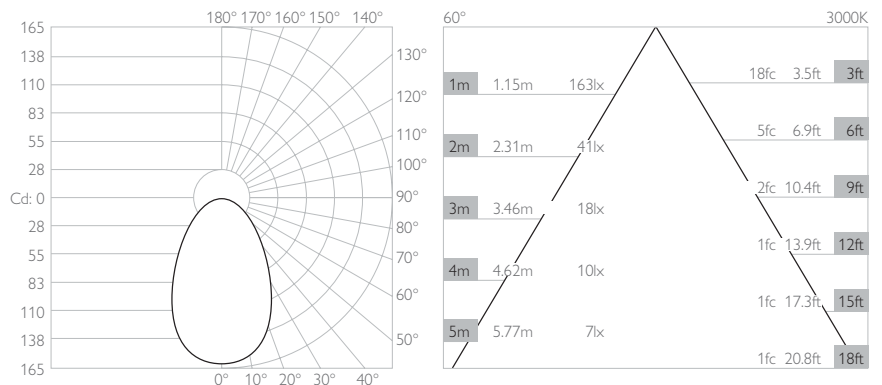
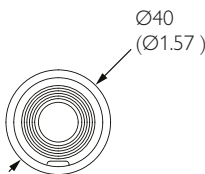
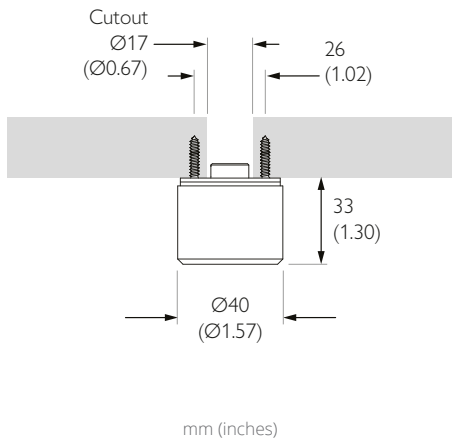

### LUMINAIRE FINISH

White 9010	Black 9005	Brushed Aluminium	Rubbed Bronze*	Polished Brass*	Brushed Brass*
TZ-651-WH-XX9560	TZ-651-BK-XX9560	TZ-651-AL-XX9560			

\*All premium & custom finishes are built & finished to order. These are subject to an extended lead time & MOQ

For 3000K Substitute XX with 30

For 2700K Substitute XX with 27

# DOMINO 1 SURFACE

## 12X35° ELLIPSE BEAM



### TECHNICAL DESCRIPTION

Domino 1 Surface is a Constant Current multi source LED spotlight that is machined from aerospace grade aluminium 6063-T6 and comes as standard in white, black and brushed aluminium. It has five site-changeable beam distributions including elliptical beams. The ellipse beam in our 2.24W 180lm module has a peak intensity of 972cd.

### MECHANICAL & ELECTRICAL

<b>CATEGORY</b> IP20	<b>WATTAGE</b> 2.24W
<b>MATERIAL</b> Machined AL 6063-T6	<b>FORWARD VOLTAGE</b> 3.2V
<b>PAN</b> N/A	<b>DRIVE CURRENT</b> 700mA
<b>TILT</b> N/A	<b>SUPPLY TYPE</b> Constant Current
<b>LOCKABLE</b> N/A	<b>DRIVER LOCATION</b> Remote
<b>WEIGHT</b> 64g   0.14lb	<b>DIMMING</b> DALI   0-10V   1-10V   Casambi

### MOUNTING





<b>MOUNTING</b> Surface mounting plate	<b>CUTOUT</b> ø17mm (0.67")
<b>CEILING THICKNESS</b> N/A	<b>MIN CEILING VOID</b> N/A

### FINISHES

**FINISHES** Brushed Aluminium | Black RAL9005 | White RAL9010

\*Premium & custom finishes are built & finished to order. These are subject to an extended lead time & MOQ.

### OPTICAL & STANDARDS

<b>NOMINAL LUMENS</b> 180lm	<b>BEAM ANGLE</b> 12x35°
<b>DELIVERED LUMENS</b> 164lm	<b>CRI</b> 95 TYP
<b>COLOUR TEMPERATURE</b> 2700K   3000K	<b>TM-30</b> RF: 93 RG: 99
<b>ACCESSORY HOLDER</b> N/A	<b>WARRANTY</b> 5 Years
<b>ACCESSORIES</b> N/A	<b>LIFETIME</b> L90B10 100,000hrs
<b>TM65</b> 7.66kgCO2e	<b>STANDARDS</b>
<b>TM66</b> 2.4	   

Photometry shown is for 3000K module. Please enquire for other CCT photometry.

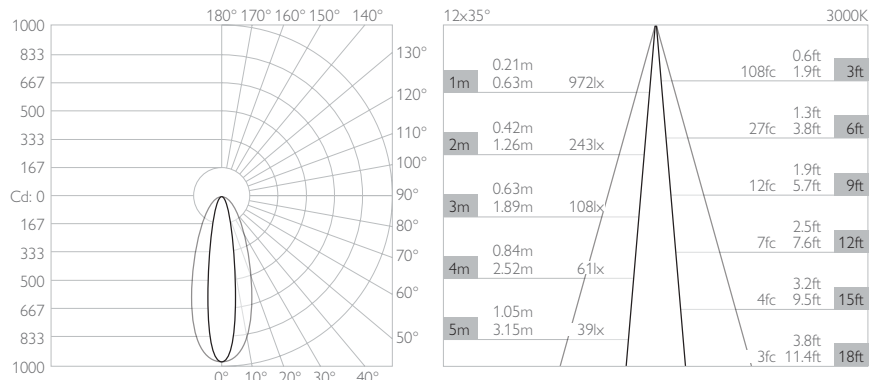
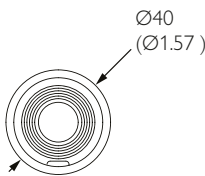
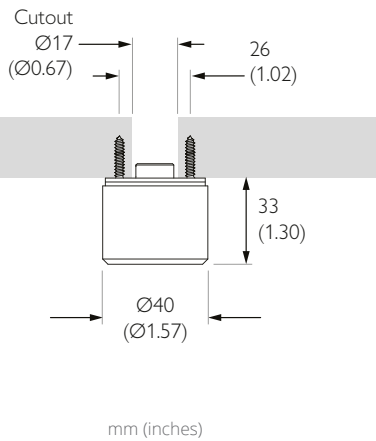

### LUMINAIRE FINISH

White 9010	Black 9005	Brushed Aluminium	Rubbed Bronze*	Polished Brass*	Brushed Brass*
TZ-651-WH-XX95E1	TZ-651-BK-XX95E1	TZ-651-AL-XX95E1			

\*All premium & custom finishes are built & finished to order. These are subject to an extended lead time & MOQ

For 3000K Substitute XX with 30

For 2700K Substitute XX with 27

# DOMINO 1 SURFACE

## 35X12° VERTICAL ELLIPSE BEAM



### TECHNICAL DESCRIPTION

Domino 1 Surface is a Constant Current multi source LED spotlight that is machined from aerospace grade aluminium 6063-T6 and comes as standard in white, black and brushed aluminium. It has five site-changeable beam distributions including elliptical beams. The vertical ellipse beam in our 2.24W 180lm module has a peak intensity of 972cd.

### MECHANICAL & ELECTRICAL

<b>CATEGORY</b> IP20	<b>WATTAGE</b> 2.24W
<b>MATERIAL</b> Machined AL 6063-T6	<b>FORWARD VOLTAGE</b> 3.2V
<b>PAN</b> N/A	<b>DRIVE CURRENT</b> 700mA
<b>TILT</b> N/A	<b>SUPPLY TYPE</b> Constant Current
<b>LOCKABLE</b> N/A	<b>DRIVER LOCATION</b> Remote
<b>WEIGHT</b> 64g   0.14lb	<b>DIMMING</b> DALI   0-10V   1-10V   Casambi

### MOUNTING





<b>MOUNTING</b> Surface mounting plate	<b>CUTOUT</b> ø17mm (0.67")
<b>CEILING THICKNESS</b> N/A	<b>MIN CEILING VOID</b> N/A

### FINISHES

**FINISHES** Brushed Aluminium | Black RAL9005 | White RAL9010

\*Premium & custom finishes are built & finished to order. These are subject to an extended lead time & MOQ.

### OPTICAL & STANDARDS

<b>NOMINAL LUMENS</b> 180lm	<b>BEAM ANGLE</b> 35x12°
<b>DELIVERED LUMENS</b> 164lm	<b>CRI</b> 95 TYP
<b>COLOUR TEMPERATURE</b> 2700K   3000K	<b>TM-30</b> RF: 93 RG: 99
<b>ACCESSORY HOLDER</b> N/A	<b>WARRANTY</b> 5 Years
<b>ACCESSORIES</b> N/A	<b>LIFETIME</b> L90B10 100,000hrs
<b>TM65</b> 7.66kgCO2e	<b>STANDARDS</b>
<b>TM66</b> 2.4	   

Photometry shown is for 3000K module. Please enquire for other CCT photometry.

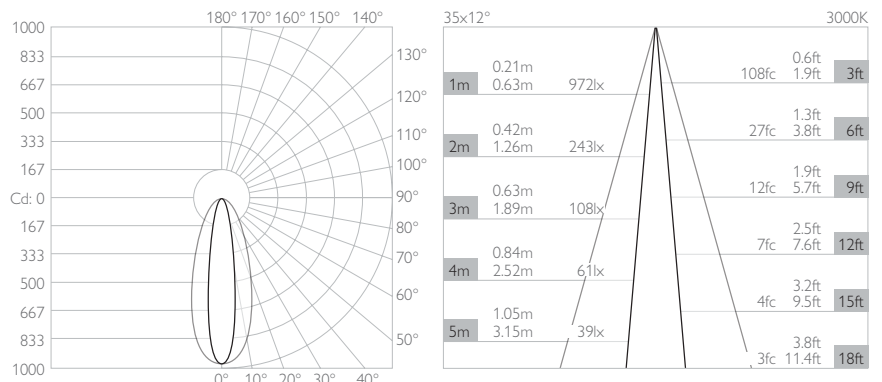
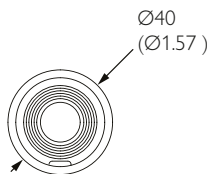
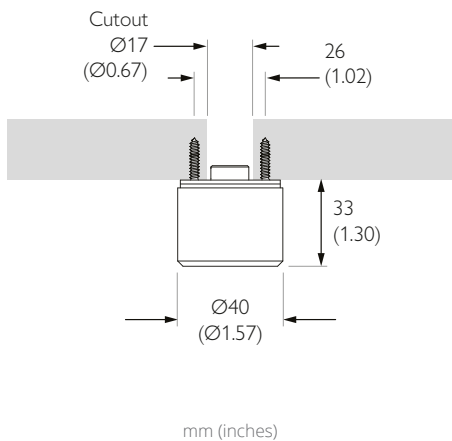

### LUMINAIRE FINISH

White 9010	Black 9005	Brushed Aluminium	Rubbed Bronze*	Polished Brass*	Brushed Brass*
TZ-651-WH-XX95E2	TZ-651-BK-XX95E2	TZ-651-AL-XX95E2			

\*All premium & custom finishes are built & finished to order. These are subject to an extended lead time & MOQ

For 3000K Substitute XX with 30

For 2700K Substitute XX with 27

# DOMINO 1

## DRIVER COMPATIBILITY

### 20W | DIMMING: DALI OR 0-10V

**NO. OF LIGHTS PER DRIVER** 1 to 8 in series  
**MIN DIM LEVEL** 0.1%  
**VOLTAGE REGION** 230V  
**FOR NORTH AMERICA** No  
**WATTAGE** 20W  
**SUPPLY TYPE** Constant Current  
**DRIVER LOCATION** Remote  
**MANUFACTURER** Eldoled

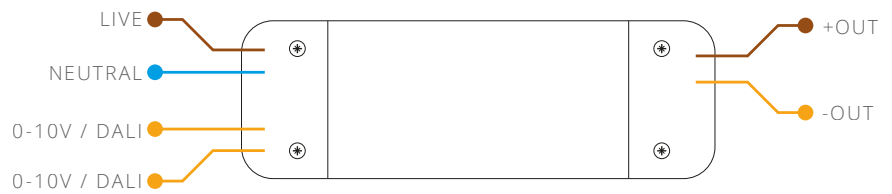

**DALI** CODE PSCC-20-700-D-EL  
**0-10V** CODE PSCC-20-700-A-EL

**LENGTH** 160mm (6.30") **WIDTH** 41mm (1.63") **HEIGHT** 30mm (1.18")



### 30W | DIMMING: DALI OR 0-10V

**NO. OF LIGHTS PER DRIVER** 1 to 12 in series  
**MIN DIM LEVEL** 0.1%  
**VOLTAGE REGION** 120V  
**FOR NORTH AMERICA** Yes  
**WATTAGE** 30W  
**SUPPLY TYPE** Constant Current  
**DRIVER LOCATION** Remote  
**MANUFACTURER** Eldoled

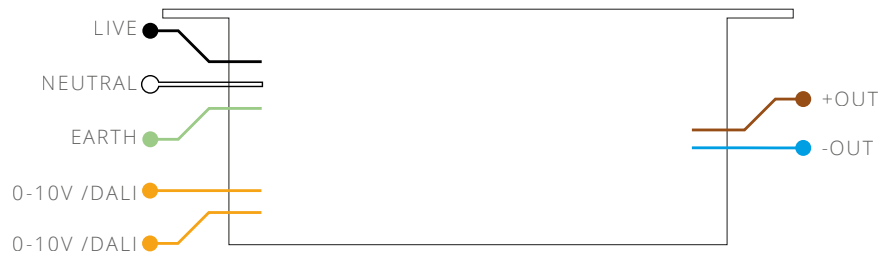

**DALI** CODE USCC-30-700-D-EL-ENC  
**0-10V** CODE USCC-30-700-A-EL-ENC

**LENGTH** 348mm (13.7") **WIDTH** 65mm (2.6") **HEIGHT** 47mm (1.9")



### 12W | DIMMING: PHASE

**NO. OF LIGHTS PER DRIVER** 2 to 5 in series  
**MIN DIM LEVEL** 1%  
**VOLTAGE REGION** 120V  
**FOR NORTH AMERICA** Yes  
**WATTAGE** 12W  
**SUPPLY TYPE** Constant Current  
**DRIVER LOCATION** Remote  
**MANUFACTURER** Hatch



**PHASE** CODE USCC-12-700-P-HT-ENC

**LENGTH** 247mm (9.7") **WIDTH** 65mm (2.6") **HEIGHT** 47mm (1.9")

